

ATyS / ATyS *r*

Remote Transfer Switching Equipment

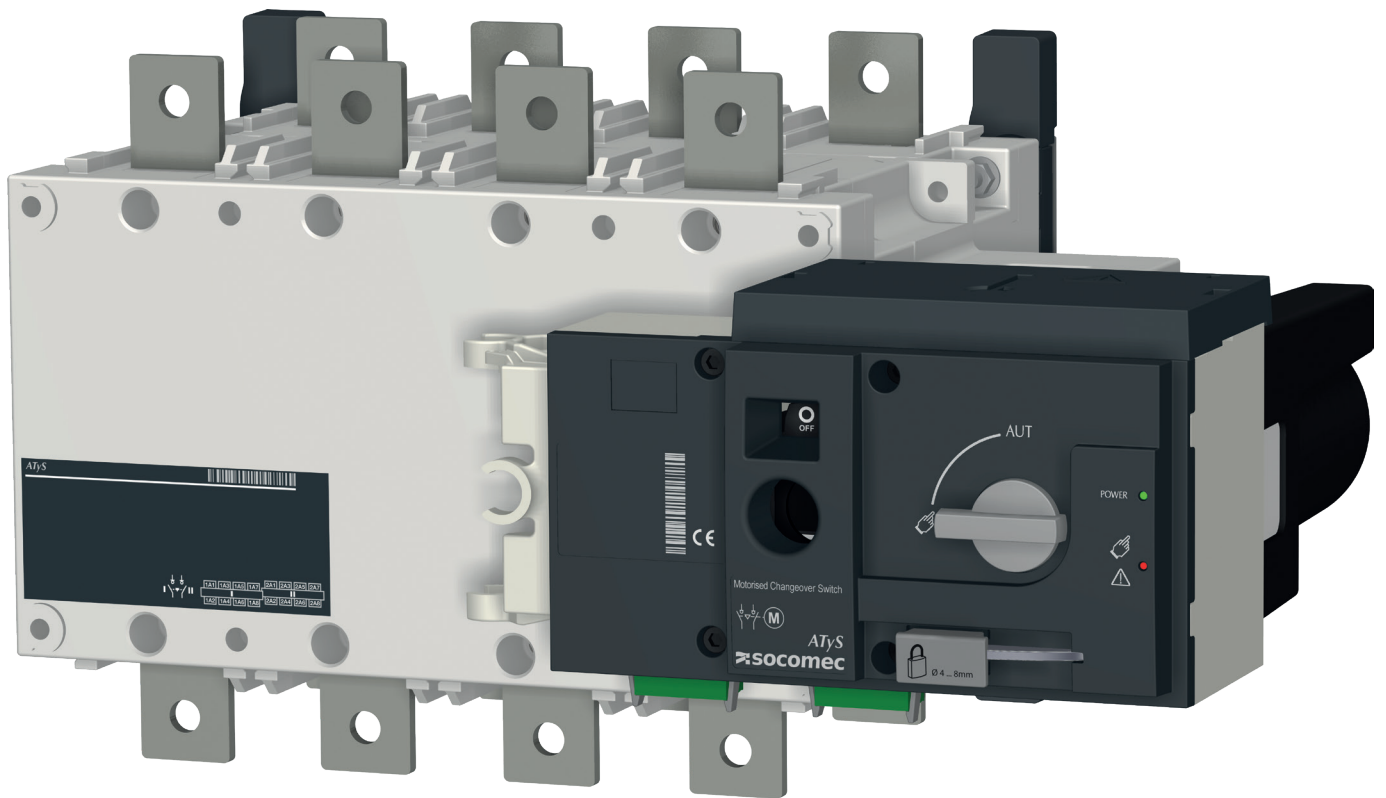

www.socomec.com
To download, brochures,
catalogues and technical manuals.

BEFORE YOU START

The current instruction manual covers the following SOCOMEC products:



- **ATyS** - Remotely operated transfer switching equipment.
- **ATyS r** - Remotely operated transfer switching equipment.
- Transfer switching part of the **ATyS A** and **ATyS C** Automatic transfer switching equipment.

1. GENERAL SAFETY INSTRUCTIONS	6
2. INTRODUCTION	7
3. THE ATYS FAMILY PRODUCT RANGE	8
3.1. THE ATYS RANGE KEY FEATURES	9
4. QUICK START	10
4.1. QUICK START ATYS R FRAME B3 TO B5 (125A TO 630A).	10
4.2. QUICK START ATYS R FRAME B6 TO B8 (800A TO 3200A).	12
5. GENERAL OVERVIEW	14
5.1. PRODUCT INTRODUCTION	14
5.2. PRODUCT IDENTIFICATION	15
5.3. ENVIRONMENTAL	16
5.3.1. IP RATING	16
5.3.2. OPERATING CONDITIONS	16
5.3.2.1. TEMPERATURE	16
5.3.2.2. HYGROMETRY	16
5.3.2.3. ALTITUDE	16
5.3.3. STORAGE CONDITIONS	16
5.3.3.1. TEMPERATURE	16
5.3.3.2. STORAGE DURATION PERIOD	17
5.3.3.3. STORAGE POSITION	17
5.3.4. VOLUME AND SHIPPING WEIGHTS BY REFERENCE ATYS	17
5.3.5. CE MARKING	18
5.3.6. LEAD FREE PROCESS	18
5.3.7. WEEE	18
5.3.8. EMC STANDARD	18
5.4. ATYS R ACCESSORIES AVAILABLE	19
6. INSTALLATION	20
6.1. PRODUCT DIMENSIONS	20
6.1.1. DIMENSIONS: FRAME B3 TO B5 (125A TO 630A)	20
6.1.2. DIMENSIONS: FRAME B6 & B7 (800A TO 1600A)	22
6.1.3. DIMENSIONS: FRAME B8 (2000A TO 3200A)	23
6.2. MOUNTING ORIENTATION	24
6.3. ASSEMBLY OF CUSTOMER MOUNTED ACCESSORIES	24
6.3.1. CLIP FOR EMERGENCY HANDLE STORAGE	24
6.3.2. BRIDGING BAR INSTALLATION	25
6.3.3. TERMINAL SHROUDS	25
6.3.4. TERMINAL SCREENS	26
6.3.5. COPPER BAR CONNECTION KITS (2000A TO 3200A : FRAME B8)	27
6.3.6. INCOMING COPPER BAR CONNECTION KIT ASSEMBLY	28
6.3.7. OUTGOING BRIDGE CONNECTION ASSEMBLY	28
6.3.8. EXTERNAL POWER SUPPLY	29
6.3.8.1. 400VAC - 230VAC POWER SUPPLY	29
6.3.8.2. 12-24VDC POWER SUPPLY	29
6.3.9. PADLOCKING KEY INTERLOCKS	30
6.3.10. ADDITIONAL AUXILIARY CONTACTS	30
7. CONNECTIONS	31
7.1. POWER CIRCUITS	31
7.1.1. CABLE OR BAR CONNECTIONS	31
7.1.2. POWER CONNECTION TERMINALS	31
7.1.3. POWER CONNECTION CROSS-SECTION	32

7.2. CONTROL CIRCUITS	33
7.2.1. TYPICAL ATYS R WIRING	33
7.2.2. ATYS R RTSE + ATS CONTROLLERS TYPE ATYS C25 AND ATYS C55/C65	33
7.2.3. ATYS R INPUT AND OUTPUT CONTACTS	34
7.2.3.1. TERMINAL DENOMINATION, DESCRIPTION AND CHARACTERISTICS.....	34
8. ATYS R OPERATING MODES	35
8.1. MANUAL OPERATION	36
8.1.1. EMERGENCY MANUAL OPERATION	36
8.1.2. PADLOCKING	36
8.2. ELECTRICAL OPERATION	37
8.2.1. POWER SUPPLY	37
8.2.2. FIXED INPUTS	37
8.2.2.1. DESCRIPTION	37
8.2.2.2. TECHNICAL DATA	38
8.2.2.3. REMOTE CONTROL LOGIC.....	38
8.2.3. FIXED OUTPUTS - DRY CONTACTS	39
8.2.3.1. DESCRIPTION	39
8.2.3.2. POSITION AUXILIARY CONTACT.....	39
8.2.3.3. ATYS R PRODUCT AVAILABLE OUTPUT (MOTORISATION).....	39
8.2.3.4. TECHNICAL DATA	40
8.3. OPERATING SEQUENCES	40
9. CHARACTERISTICS.....	41
10. PREVENTIVE MAINTENANCE	44
11. TROUBLE SHOOTING GUIDE.....	44
12. ACCESSORIES	45
12.1. TERMINAL SHROUDS	45
12.2. TERMINAL SCREENS.....	45
12.3. BRIDGING BARS	45
12.4. COPPER BAR CONNECTION KITS	46
12.5. SOLID NEUTRAL	46
12.6. AUTOTRANSFORMER 400/230 VAC	46
12.7. DC POWER SUPPLY	47
12.8. VOLTAGE RELAY	47
12.9. DOOR PROTECTIVE SURROUND	47
12.10. AUXILIARY CONTACTS (ADDITIONAL)	47
12.11. 3 POSITION PADLOCKING (I - 0 - II)	47
12.12. RONIS KEY INTERLOCKING SYSTEM	48
12.13. ATS CONTROLLERS ATYS C25/C55/C65	48
12.14. AUTO/MANUAL KEY SELECTOR	48
12.15. DOUBLE POWER SUPPLY - DPS	48
13. SPARE PARTS	49
13.1. MOTORISATION MODULE	49
13.2. POWER SECTION.....	49
13.3. KIT OF CONNECTORS.....	49
13.4. METAL MOUNTING BRACKETS	49
14. ATYS FAMILY: ORDERING INFORMATION	50

1. GENERAL SAFETY INSTRUCTIONS

- This manual provides instructions on safety, connections and operation of the ATyS r motorised changeover switch manufactured by SOCOMEC.
- Whether the ATyS r is sold as a loose product, as a spare, as an enclosed solution or as any other configuration, this device must always be installed and commissioned by qualified and experienced personnel, in line with the manufacturers recommendations, following good engineering practices and after having read and understood the details in the latest release of the relative product instruction manual.
- Maintenance on the product and any other associated equipment including but not limited to servicing operations must be performed by adequately trained and qualified personnel.
- Each product is shipped with a label or other form of marking including rating and other important specific product information. One must also refer to and respect markings on the product prior to installation and commissioning for values and limits specific to that product.
- Using the product outside the intended scope, outside SOCOMEC recommendations or outside the specified ratings and limits can cause personal injury and/or damage to equipment.
- This instruction manual must be made accessible so as to be easily available to anyone who may need to read it in relation with the ATyS r.
- The ATyS r meets the European Directives governing this type of product and includes CE marking on each product.
- No covers on the ATyS r should be opened (with or without voltage) as there may still be dangerous voltages inside the product such as those from external circuits.
- **Do not handle any control or power cables connected to the ATyS r when voltage may be present on the product directly through the mains or indirectly through external circuits.**
- Voltages associated with this product may cause injury, electric shock, burns or death. Prior to carry out any maintenance or other work on live parts or other parts in the vicinity of exposed live parts, ensure that the switch including all control and associated circuits are de-energized.

 DANGER	 WARNING	 CAUTION
RISK: Electric shock, burns, death	RISK: Possible personal injury	RISK: Equipment damage

- As a minimum the ATyS r comply with the following international standards:
 - IEC 60947-6-1
 - GB 14048-11
 - EN 60947-6-1
 - VDE 0660-107
 - BS EN 60947-6-1
 - NBN EN 60947-6-1
 - IEC 60947-3
 - IS 13947-3
 - EN 60947-3
 - NBN EN 60947-3
 - BS EN 60947-3

The information provided in this instruction manual is subject to change without notice, remains for general information only and is non-contractual.

2. INTRODUCTION

ATyS r “remotely operated transfer switching equipment” (RTSE) is designed for use in power systems for the safe transfer of a load supply between a normal and an alternate source. The changeover is done in open transition and with minimum supply interruption during transfer ensuring full compliance with IEC 60947-6-1, GB 14048-11 and other international TSE standards as listed.

The ATyS r is a full load break (switch type) derived transfer switching equipment where the main components are proven technology devices also fulfilling requirements in IEC 60947-3 standards.

As a Class PC RTSE, the ATyS r is capable of “making and withstanding short circuit currents” assigned to IEC 60947-3 utilization categories of up to AC23A, GB 14048-11, IEC 60947-6-1 and equivalent standards with utilization categories of up to AC33B.

ATyS r motorised source changeover switches ensure:

- Power Control and Safety between a normal and an alternate source.
- A complete product delivered as a fully assembled and tested solution.
- Intuitive HMI for emergency / local operation.
- Integrated and robust switch disconnection.
- Window with clearly visible position indication I – 0 - II.
- An inherent failsafe mechanical interlock.
- Stable positions (I – 0 – II) non affected by typical vibration and shock.
- Constant pressure on the contacts non affected by network voltage.
- Energy Efficient with virtually no consumption whilst on the normal, alternate or off positions.
- Quick, easy and safe dual “on-load” emergency manual operation.
(Manual operation is functional with and without the motorization in place).
- Extremely rugged, error free and built in padlocking facility.
- Straight forward installation with effective ergonomics.
- Minimal downtime with the possibility to perform easy maintenance.
- Simple and secure motorization controls interface.
- Integrated switch position auxiliary contacts.
- An active “product availability” status feedback.
- Ample accessories to suit specific requirements.
- Compatibility with virtually any brand of ATS, AMF, Genset controller.
(Typically an ATyS C25 / C55 / C65 ATS Controller and driven through volt free contacts)
- Power supply continuity for most applications.

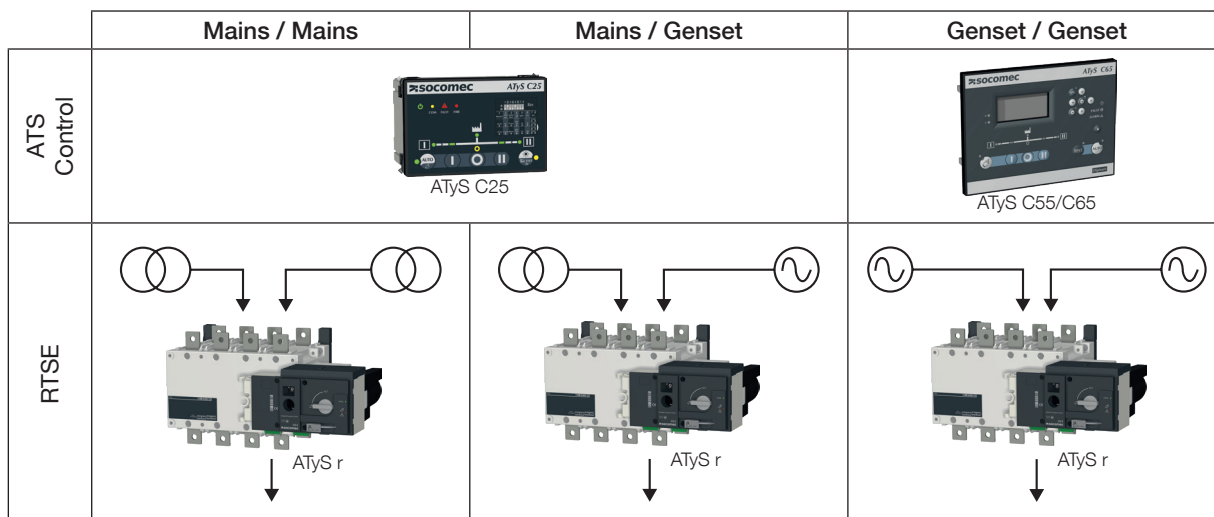

3. THE ATyS FAMILY PRODUCT RANGE

The ATyS r has been engineered by the SOCOMEC centre of excellence in France who boasts it's very own in-house 100MVA instantaneous power test lab accredited by COFRAC and working in partnership with: KEMA, CEPEC, UL, CSA, ASTA, Lloyd's Register of Shipping, Bureau Veritas, BBJ-SEP, EZU, GOST-R... and others.





SOCOME C has been manufacturing power control and safety products since 1922. The first generation SOCOMEC "motorised changeover switches" were introduced in 1990 and today the ATyS brand has become trusted by major players in the power industry worldwide.

The ATyS Family includes a complete range of remotely operated transfer switch equipment (RTSE) as well as automatic fully integrated products and solutions (ATSE). Selecting the right ATyS will depend on the application as well as the nature of installation in which the ATyS will be installed.

This instruction manual includes details and instructions specific to the "ATyS r" RTSE only. For all other ATyS family of products please refer to the specific instruction manual related to that product.
(Available for download on www.socomec.com)

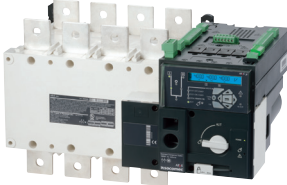
An overview of the complete ATyS range is presented below:
(The encircled device is the product detailed in this instruction manual).

Just the right ATyS for your application...

ATyS: Small Footprint	ATyS M: Modular Profile
<p>Back to Back Configuration</p>  <p>125A - 3200A ↑</p> <p>ATyS p Power / Genset Management</p>  <p>40A - 125A ↑</p> <p>ATyS g Simple Genset Management</p> <p>ATyS t Transformer Management</p> <p>ATyS d S Small Genset with DPS</p> <p>ATyS d RTSE (DPS)</p> <p>ATyS S (RTSE) Small Genset</p> <p>ATyS r (1) ATyS  RTSE RTSE</p>	 <p>40A - 160A ↑</p> <p>ATyS p M Evolved Genset Management</p> <p>ATyS g M Simple Genset Management</p> <p>ATyS t M Transformer (building) Management</p> <p>ATyS d M RTSE (DPS)</p> <p>Side by Side Configuration</p>

(1) The UL version of ATyS r is available from 100 - 400A

3.1. The ATyS Range Key Features

Selecting the right ATyS will depend on the application, the functionality required as well as the nature of the installation in which the ATyS will be installed. Below is an outline product selection chart listing the key features of each product to help to select the right ATyS for your needs.

	IEC 60947-6-1	ATyS <i>S</i>	ATyS <i>Sd</i>	ATyS <i>r</i>	ATyS <i>d</i>	ATyS <i>t</i>	ATyS <i>g</i>	ATyS <i>p</i>
	UL 1008			ATyS 				
Motorised Changeover with control driven by dry contacts		•	•	•	•	•	•	•
Manual Emergency Operation with external handle		•	•	•	•	•	•	•
Wide band AC control voltage supply		•	•	•	•	•	•	•
Wide band DC control voltage supply		•						
Watchdog relay to ensure product availability				•	•	•	•	•
Ratings from 40 – 125A as indicated or 125A - 3200A for •		40 – 125A	40 – 125A	UL 100 – 400A	•	•	•	•
Override controls and force switch to zero (off) position				•	•	•	•	•
Integrated position auxiliary contacts (I - O - II)		•	•	•	•	•	•	•
Source availability LED display					•	•	•	•
Remote Display module RJ45 connection for D10					•	•	•	
Integrated Dual power supply			•		•	•	•	•
Network - Network Applications		•	•	•	•	•		•
Network - Genset Applications		•	•	•	•		•	•
Genset - Genset Applications		•	•	•	•			
Pre-defined fixed I/O				• 5/1	• 5/1	• 9/2	• 11/3	• 5/2
Programmable I/O								• 6/1
Additional programmable I/O modules (Optional up to 4 modules)								• 8/8
Remotely operated Transfer Switching Equipment (RTSE Class PC)		•	•	•	•			
Automatic Transfer Switching Equipment (ATSE Class PC)						•	•	•
Remote + Manual Control		•	•	•	•			
Auto + Remote + Manual Control						•	•	
Auto + Remote + Local + Manual Control								•
Auto-configuration of voltage and frequency levels						•	•	•
Switch Position LED display						•	•	•
Security Sealing Cover						•	•	
Configuration through potentiometers and dip switches						•	•	
Test on load functionality							•	•
Test off load functionality							•	•
Programmable configuration with keypad and LCD display								•
Metering & Measurement: kW; kVar; kVA + kWh; kVarh; kVAh								•
Communication RS485 + Ethernet + Ethernet gateway (Optional)							•	•
Webserver Access through optional Ethernet module (Optional)								•
Easy Configuration software (Through Ethernet/Modbus)								•
Remote Terminal Unit RJ45 connection for D20								•
Data Logger for Event Recording with RTC (Through Ethernet/Modbus)								•
Programmable Engine Exerciser functionality (Through Ethernet/Modbus)								•
Multi level password access								•
Load Shedding function								•
Capacity Management functionality								•
Peak shaving functionality								•
4 - 20mA communication module (Optional)								•
KWh Pulsed output module (Optional)								•
Counters KWh, permutation...								•
LCD display for programming, metering, timers and counters								•
Possibility to add optional functionality								•

4. QUICK START

4.1. Quick Start ATyS r Frame B3 to B5 (125A to 630A)

socomec
Innovative Power Solutions



549603D

QUICK START EN 125 A - 630 A

ATyS / ATyS r

Motorised Source Changeover Switch

Preliminary operations

Check the following upon delivery and after removal of the packaging:

- Packaging and contents are in good condition.
- The product reference corresponds to the order.
- Contents should include:
 - Qty 1 x ATyS / ATyS r
 - Qty 1 x Emergency handle and fixing clip
 - Quick Start instruction sheet

Warning

⚠ Risk of electrocution, burns or injury to persons and / or damage to equipment.

This Quick Start is intended for personnel trained in the installation and commissioning of this product. For further details refer to the product instruction manual available on the SOCOMEC website.

- This product must always be installed and commissioned by qualified and approved personnel.
- Maintenance and servicing operations should be performed by trained and authorised personnel.
- Do not handle any control or power cables connected to the product when voltage may be, or may become present on the product, directly through the mains or indirectly through external circuits.
- Always use an appropriate voltage detection device to confirm the absence of voltage.
- Ensure that no metal objects are allowed to fall in the cabinet (risk of electrical arcing).

- For 125 - 160 A (Uimp = 8 kV). Terminations must respect a minimum of 8 mm clearance from live parts to parts intended to be earthed and between poles.
- For 200 - 630 A (Uimp = 12 kV). Terminations must respect a minimum of 14 mm clearance from live parts to parts intended to be earthed and between poles.

Failure to observe good engineering practises as well as to follow these safety instructions may expose the user and others to serious injury or death.

⚠ Risk of damaging the device
In case the product is dropped or damaged in any way it is recommended to replace the complete product.

Accessories

- Bridging bars and connection kits.
- Control voltage transformer (400 VAC → 230 VAC).
- DC power supply (12/24 VDC → 230 VAC).
- Phase barriers.
- Terminal shrouds.
- Terminal screens.
- Auxiliary contacts (Additional).
- Padlocking in 3 positions (I - 0 - II).
- Lockout accessories (RONIS - EL 11 AP).
- Door escutcheon frame.
- ATS controller ATyS C25.
- ATS controller ATyS C55 or C65.

For further details refer to the product instruction manual under chapter "Spares and Accessories".



www.socomec.com
To download brochures, catalogues and technical manuals:
https://www.socomec.com/operating-instructions_en.html

Installation and Commissioning

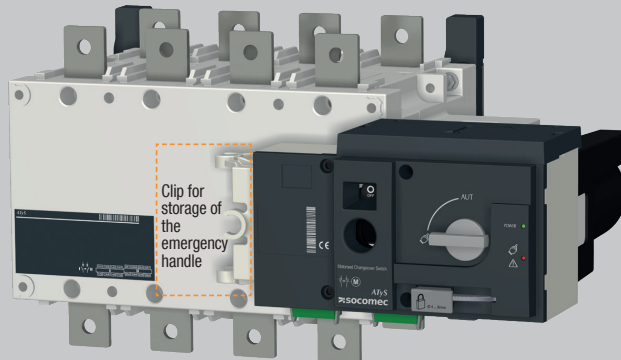
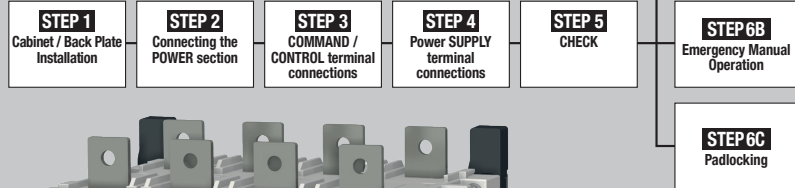

STEP 1 Installation

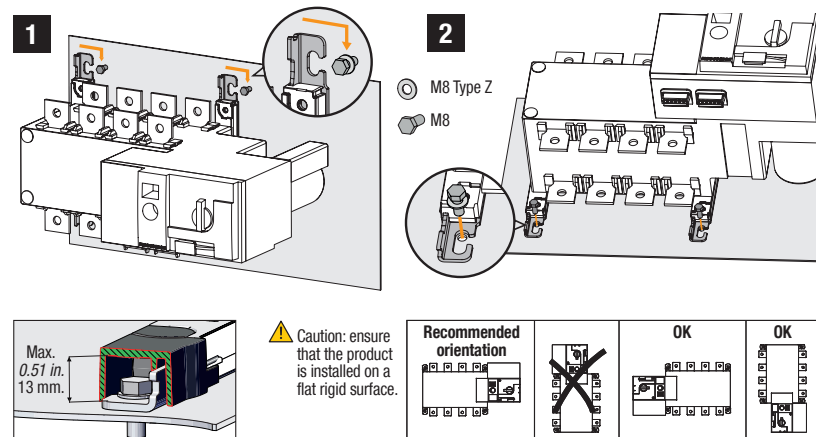

3 Mounting

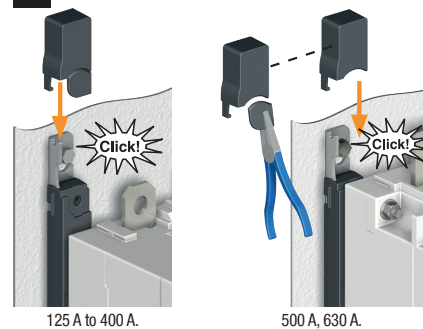

Removing covers

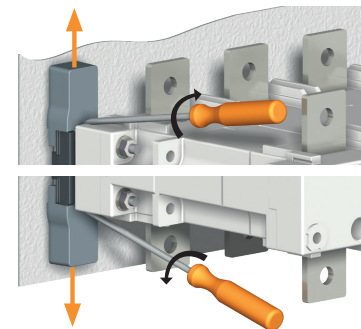

STEP 2 Power Terminal Connections

To be connected using terminal lugs, rigid or flexible busbars.

	FRAME B3			FRAME B4			FRAME B5	
	125 A	160 A	200 A	250 A	315 A	400 A	500 A	630 A
Minimum cable section Cu (mm ²)	35	35	50	95	120	185	2x95	2x120
Recommended Cu busbar cross-section (mm ²)	-	-	-	-	-	-	2x32x5	2x40x5
Maximum Cu cable cross-section (mm ²)	50	95	120	150	240	240	2x185	2x300
Maximum Cu busbar width (mm)	25	25	25	32	32	32	50	50
Type of screw	M8	M8	M8	M10	M10	M10	M12	M12
Recommended tightening torque (lb.in/N.m)	73.46/8.3	73.46/8.3	73.46/8.3	177.02/20	177.02/20	177.02/20	354.04/40	354.04/40
Maximum tightening torque (lb.in/N.m)	115.06/13	115.06/13	115.06/13	230.13/26	230.13/26	230.13/26	398.30/45	398.30/45

STEP 3 CONTROL / COMMAND Terminals

Ensure that the product is in Manual Mode.

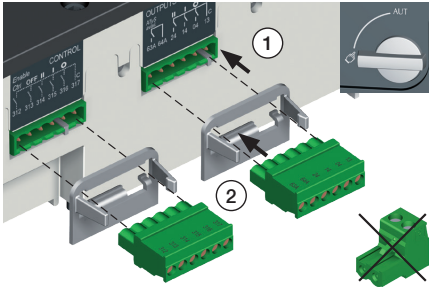

Connect the product with a cable of section of 1,5 to 2,5 mm².

Screw M3 - Tightening torque:
min.: 0.5 Nm - max.: 0.6 Nm
min.: 4.43 lbin - max.: 5.31 lbin

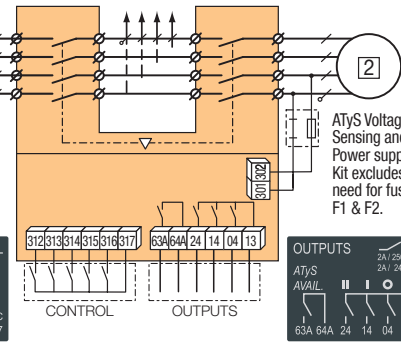
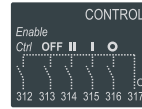

STEP 4 Power Supply Terminal

Remove the Top cover to access and connect the terminal - Replace the cover before putting in service.

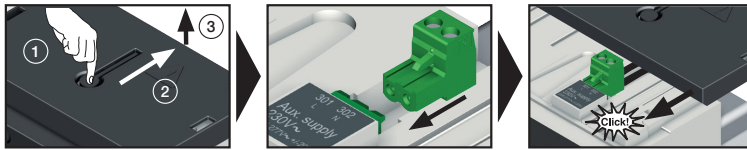

STEP 5 Check

Whilst in manual mode, check the wiring and if ok power up the product.

LED "Power" Green: ON
LED Manuel/Default Red (Product not Available): ON

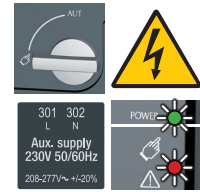

STEP 6A Automatic Operation

Ensure that the emergency handle is not inserted in the product and turn the mode selector to the AUT position.

LED "Power" Green: ON
LED Manuel/Default: OFF

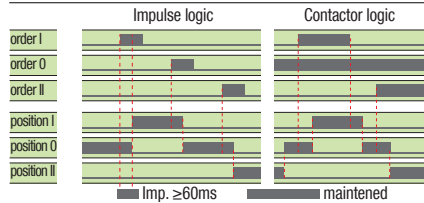

To enable control, close contact 312 with 317.
To force the product to 0 position/OFF bridge the contact 313 with 317. For contactor logic bridge contact 316 with 317. To operate: close the contact corresponding to the desired position.

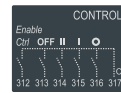

Dimensions in./mm.

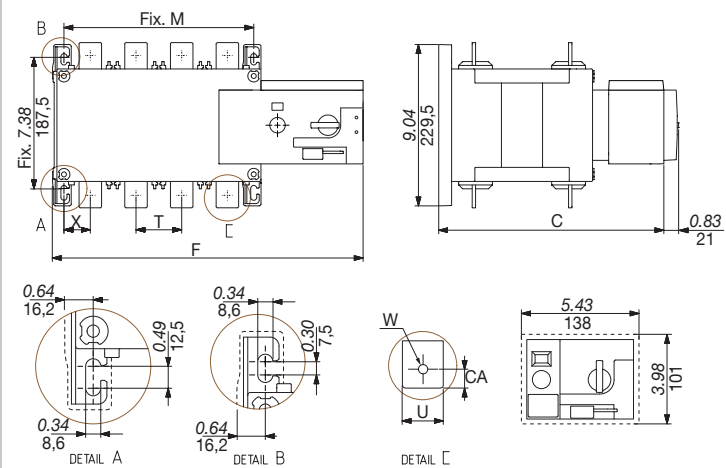

STEP 6B Manual Operation

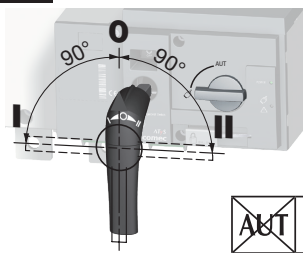

STEP 6C Padlocking Mode (as standard : in position 0)

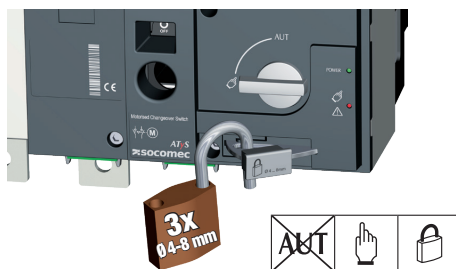

	125 A		160 A		200 A		250 A					
	3 P	4 P	3 P	4 P	3 P	4 P	3 P	4 P				
C	9.61	244	9.61	244	9.61	244	9.61	244	9.61	244	9.61	244
CA	0.39	10	0.39	10	0.39	10	0.39	10	0.59	15	0.59	15
F	11.28	286.5	12.48	317	11.28	286.5	12.48	317	12.91	328	14.88	378
M	4.72	120	5.91	150	4.72	120	5.91	150	6.30	160	8.27	210
T	1.42	36	1.42	36	1.42	36	1.42	36	1.97	50	1.97	50
U	0.79	20	0.79	20	0.79	20	0.79	20	0.98	25	0.98	25
W	0.35	9	0.35	9	0.35	9	0.35	9	0.43	11	0.43	11
X	1.10	28	0.87	22	1.10	28	0.87	22	1.30	33	1.30	33

	315 A		400 A		500 A		630 A					
	3 P	4 P	3 P	4 P	3 P	4 P	3 P	4 P				
C	9.61	244	9.61	244	12.64	321	12.64	321	12.64	321	12.64	321
CA	0.59	15	0.59	15	0.59	15	0.59	15	0.79	20	0.79	20
F	12.91	328	14.88	378	12.91	328	14.88	378	14.84	377	17.20	437
M	6.30	160	8.27	210	6.30	160	8.27	210	10.63	270	8.27	210
T	1.97	50	1.97	50	1.97	50	2.56	65	2.56	65	2.56	65
U	1.38	35	1.38	35	1.38	35	1.26	32	1.26	32	1.77	45
W	0.43	11	0.43	11	0.43	11	0.55	14	0.55	14	0.51	13
X	1.30	33	1.30	33	1.30	33	1.67	42.5	1.48	37.5	1.67	42.5

4.2. Quick Start ATyS r Frame B6 to B8 (800A to 3200A)

socomec
Innovative Power Solutions



QUICK START EN 800 A - 3200 A

ATyS / ATyS r

Motorised Source Changeover Switch

Preliminary operations

Check the following upon delivery and after removal of the packaging:

- Packaging and contents are in good condition.
- The product reference corresponds to the order.
- Contents should include:
 - Qty 1 x ATyS / ATyS r
 - Qty 1 x Emergency handle and fixing clip
 - Quick Start instruction sheet

Warning

⚠ Risk of electrocution, burns or injury to persons and / or damage to equipment.

This Quick Start is intended for personnel trained in the installation and commissioning of this product. For further details refer to the product instruction manual available on the SOCOMECE website.

- This product must always be installed and commissioned by qualified and approved personnel.
- Maintenance and servicing operations should be performed by trained and authorised personnel.
- Do not handle any control or power cables connected to the product when voltage may be, or may become present on the product, directly through the mains or indirectly through external circuits.
- Always use an appropriate voltage detection device to confirm the absence of voltage.
- Ensure that no metal objects are allowed to fall in the cabinet (risk of electrical arcing).

- For 800 - 3200 A (Uimp = 12 kV), Terminations must respect a minimum of 14 mm clearance from live parts to parts intended to be earthed and between poles.

Failure to observe good engineering practises as well as to follow these safety instructions may expose the user and others to serious injury or death.

⚠ Risk of damaging the device
In case the product is dropped or damaged in any way it is recommended to replace the complete product.

Accessories

- Bridging bars and connection kits.
- Control voltage transformer (400 VAC → 230 VAC).
- DC power supply (12/24 VDC → 230 VAC).
- Phase barriers.
- Terminal shrouds.
- Terminal screens.
- Auxiliary contacts (Additional).
- Padlocking in 3 positions (I - O - II).
- Lockout accessories (RONIS - EL 11 AP).
- Door escutcheon frame.
- ATS controller ATyS C25.
- ATS controller ATyS C55 or C65.

For further details refer to the product instruction manual under chapter "Spares and Accessories"



www.socomec.com
To download, brochures, catalogues and technical manuals:
https://www.socomec.com/operating-instructions_en.html

Installation and Commissioning

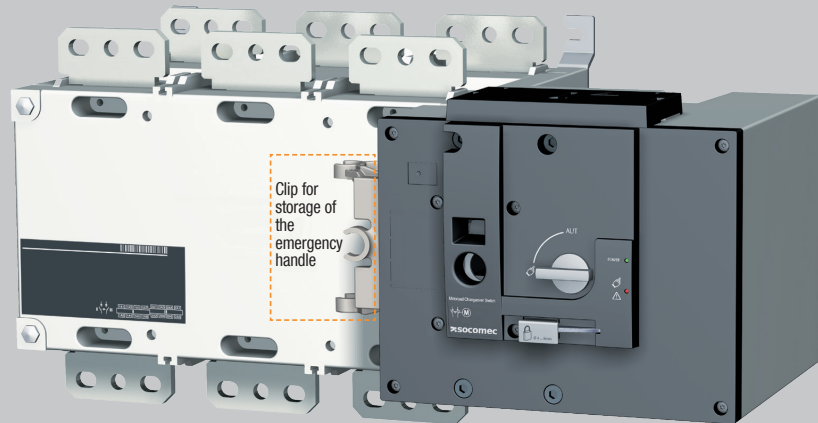
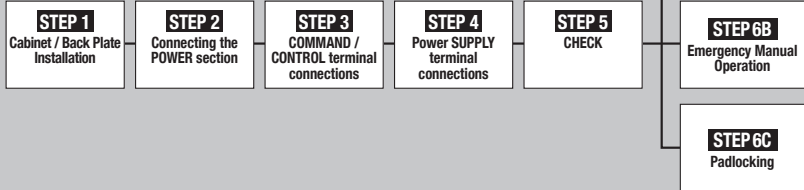

STEP 1 Installation

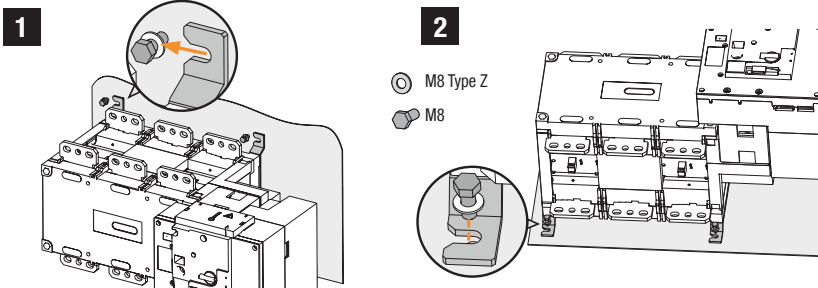

⚠ Caution: ensure that the product is installed on a flat rigid surface.

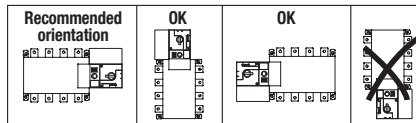

STEP 2 Power Terminal Connections

To be connected using terminal lugs, rigid or flexible busbars.	FRAME B6			FRAME B7		FRAME B8	
	800 A	1000 A	1250 A	1600 A	2000 A	2500 A	3200 A
Minimum cable section Cu (mm ²)	2x185	-	-	-	-	-	-
Recommended cable section Cu (mm ²)	2x50x5	2x63x5	2x63x7	2x100x5	3x100x5	2x100x10	3x100x10
Maximum Cu cable cross-section (mm ²)	4x185	4x185	4x185	6x185	-	-	-
Maximum Cu busbar width (mm)	63	63	63	100	100	100	100
Type of screw	M8	M8	M10	M12	M12	M12	M12
Recommended tightening torque (lb.in/N.m)	73.46/8.3	73.46/8.3	177.02/20	354.04/40	354.04/40	354.04/40	354.04/40
Maximum tightening torque (lb.in/N.m)	115.06/13	115.06/13	230.13/26	398.30/45	398.30/45	398.30/45	398.30/45

STEP 3 CONTROL / COMMAND Terminals

Ensure that the product is in Manual Mode.

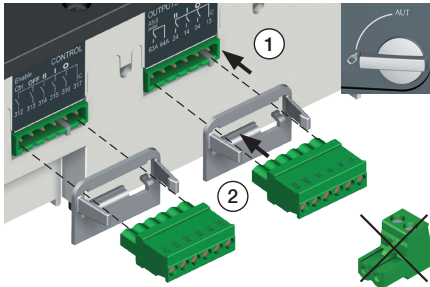

Connect the product with a cable of section of 1,5 to 2,5 mm².

Screw M3 - Tightening torque:
min.: 0.5 Nm - max.: 0.6 Nm
min.: 4.43 lbin - max.: 5.31 lbin

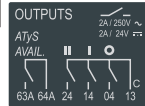
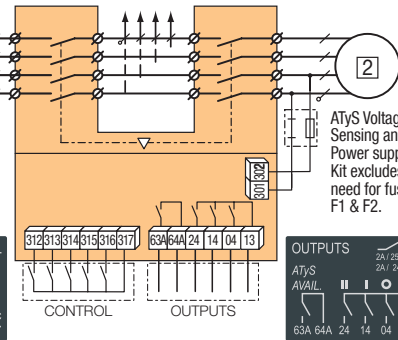
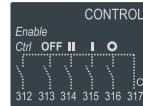

STEP 4 Power Supply Terminal

Remove the Top cover to access and connect the terminal - Replace the cover before putting in service.

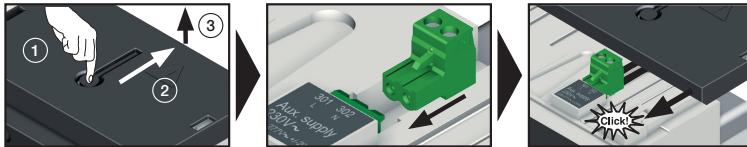

STEP 5 Check

Whilst in manual mode, check the wiring and if ok power up the product.

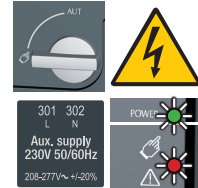

STEP 6A Automatic Operation

Ensure that the emergency handle is not inserted in the product and turn the mode selector to the AUT position.

LED "Power" Green: ON
LED Manual/Default: OFF

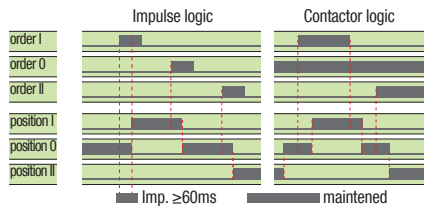
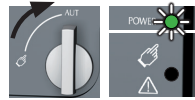

To enable control, close contact 312 with 317.
To force the product to 0 position/OFF bridge the contact 313 with 317. For contactor logic bridge contact 316 with 317. To operate: close the contact corresponding to the desired position.



STEP 6B Manual Operation

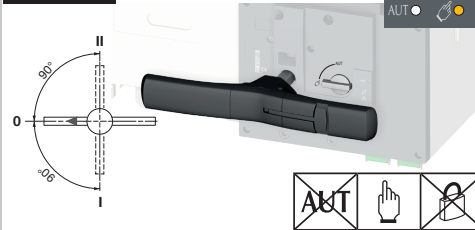

STEP 6C Padlocking Mode (as standard: in position 0)



Dimensions in./mm.

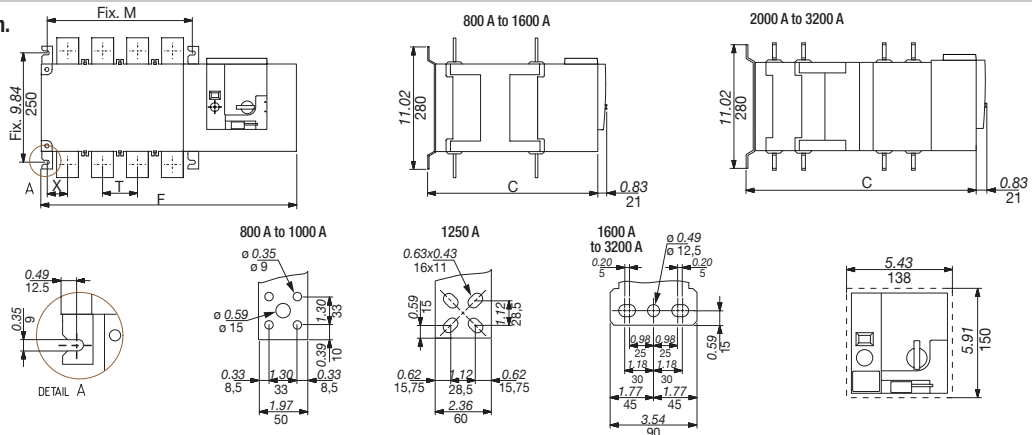

	800 A		1000 A		1250 A		1600 A		2000 A		2500 A		3200 A	
	3 P	4 P	3 P	4 P	3 P	4 P	3 P	4 P	3 P	4 P	3 P	4 P	3 P	4 P
C	15.39	391	15.39	391	15.39	391	15.39	391	523	20.59	523	20.59	523	20.59
F	19.84	504	22.99	584	19.84	504	22.99	584	23.46	596	28.19	716	23.46	596
M	10.04	255	13.19	335	10.04	255	13.19	335	13.66	347	18.39	467	13.66	347
T	3.15	80	3.15	80	3.15	80	3.15	80	4.72	120	4.72	120	4.72	120
X	1.87	47.5	1.87	47.5	1.87	47.5	1.87	47.5	2.09	53	2.09	53	2.11	53.5

CORPORATE HQ CONTACT: SOCOMEC SAS 1-4 RUE DE WESTHOUSE - 67235 BENFELD, FRANCE - WWW.SOCOMECS.COM

Non contractual document. Subject to change without notice. CE

5. GENERAL OVERVIEW

5.1. Product introduction

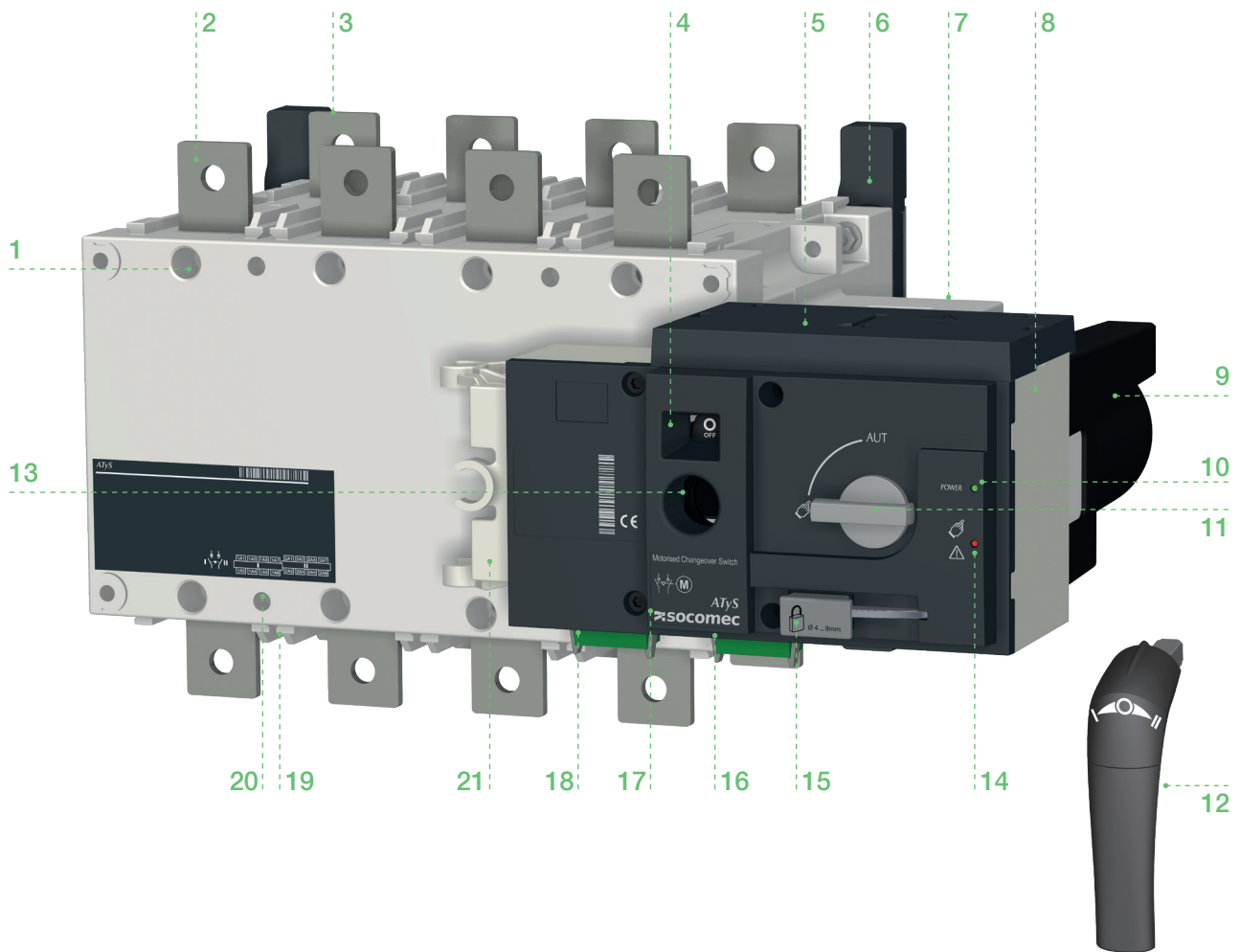

1. Power Section : Changeover switch assembly with inherent mechanical interlock
2. Front : Switch number 1 terminals (3 or 4 pole)
3. Back : Switch number 2 terminals (3 or 4 pole)
4. Switch position indication window :- I (On) – O (Off) – II (On)
5. Auxiliary power supply : 230Vac (208 – 277Vac ± 20%)
6. Back-plate mounting ATyS fixing brackets
7. Additional Pre breaking and signaling position (I and II) auxiliary contacts.
8. Motorized Control Unit
9. Motor housing
10. Green LED Indication : Power (ATyS control voltage input within specified range).
11. Auto / Manual mode selector switch
12. Emergency manual operation “Direct Handle”
13. Emergency manual operation shaft location (Accessible only in manual mode)
14. Red LED Indication : Product Unavailable / Manual Mode / Fault Condition
15. Padlocking facility (Up to 3 padlocks of dia. 4 – 8mm)
16. Output contacts x 4 (Position indication I-O-II and product availability outputs)
17. Facility for locking all controls in the zero position using a RONIS EL11AP Lock
18. Input contacts x 5 :-
 Position order I-O-II
 Remote control enable
 Override controls and force to Off position
19. Sliders for Terminal Shields
20. Fixing holes for terminal Shields
21. Clip for emergency handle storage

5.2. Product identification

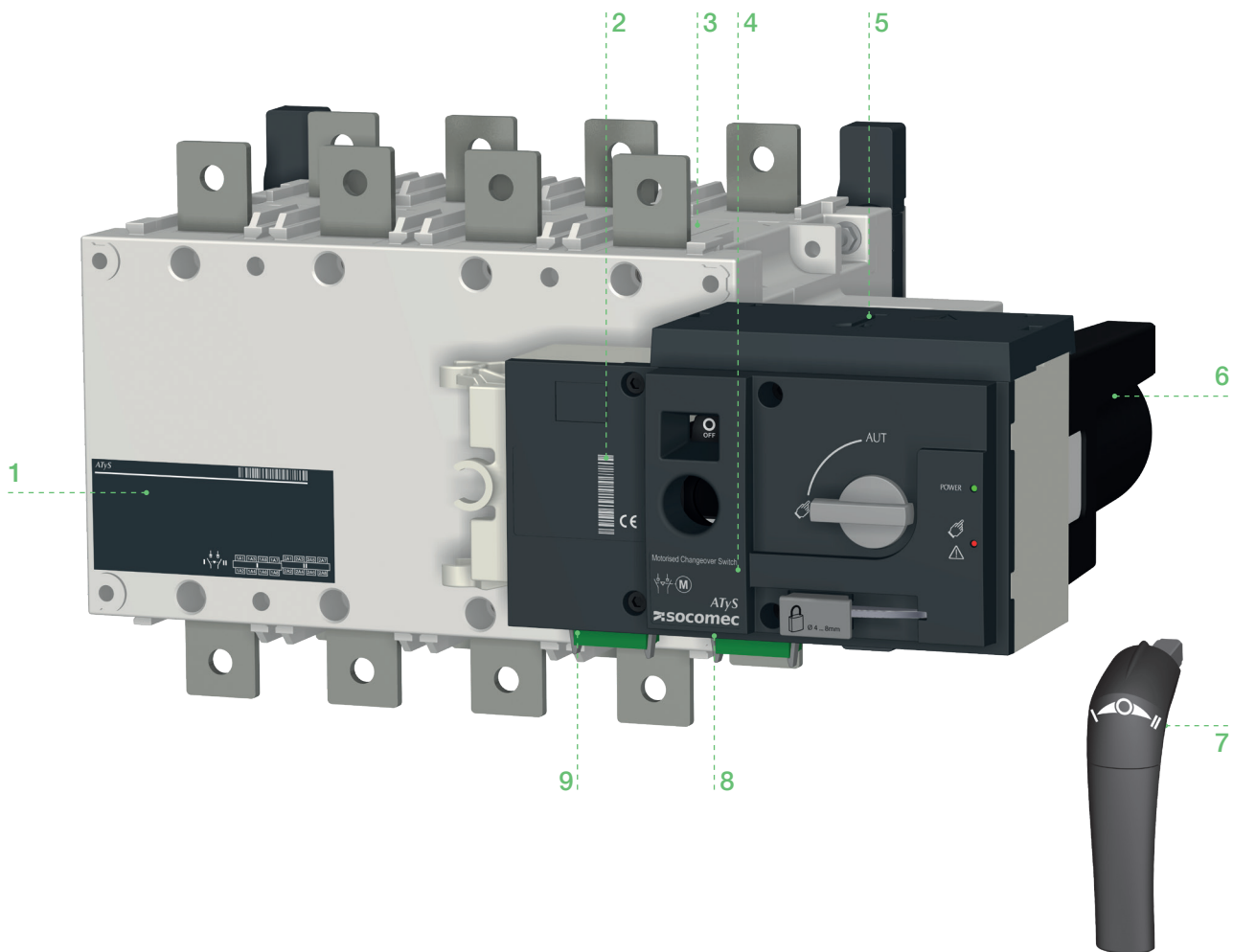

1. Main changeover switch identification label:
Electrical characteristics
Applicable standards and
Terminal incoming and outgoing wiring details.
2. Product serial number, barcode and CE marking.
3. Switch 1 (Front) and Switch 2 (back) identification labels
4. ATyS r product current rating and reference number label
5. Auxiliary power supply contacts identification label
6. Motor barcode and serial number
7. Emergency manual operation direction of rotation indication
8. Output contacts identification label
9. Input contacts identification label

5.3. Environmental

The ATyS r product meets the following environmental requirements:

5.3.1. IP Rating



- IP2X against direct contact for the ATyS r motorization control unit.
- IP2X against direct contact for the power section with the connections in place and when including suitable, correctly installed incoming and outgoing terminal shields.
- IP 0 for the bare power section without terminal shields in place.

5.3.2. Operating Conditions

5.3.2.1. Temperature



- From -20 to +40°C without derating
- From -20 to +70°C when applying a Kt derating correction factor

Kt: Correction Factor	Temperature
0.9	40 °C ... 50 °C
0.8	50 °C ... 60 °C
0.7	60 °C ... 70 °C

* Simplified derating method: $I_{thu} \leq I_{th} \times K_f$

* A more precise calculation may be done for specific applications. Should this be required please contact SOCOMEC.

5.3.2.2. Hygrometry



- 80% humidity without condensation at 55°C
- 95% humidity without condensation at 40°C

5.3.2.3. Altitude



- Up to 2000m in altitude without derating
- For higher altitude the Ka correction factors below apply

Ka: Correction Factor	2000 m < A ≤ 3000 m	3000 m < A ≤ 4000 m
Ue	0.95	0.8
Ie	0.85	0.85

5.3.3. Storage Conditions

5.3.3.1. Temperature



- From -40 to +70°C

5.3.3.2. Storage duration period

- Maximum storage up to a period of 12 months
- (Recommendation: To be stored in dry, non corrosive and non saline atmospheric conditions)

5.3.3.3. Storage position



≤ 630 A: a maximum of 3 boxes may be stocked vertically
 ≥ 800 A: a maximum of 1 box may be stocked vertically

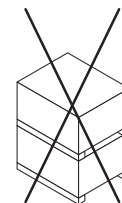
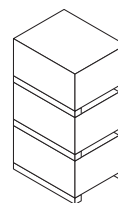

5.3.4. Volume and shipping weights by reference ATyS

Frame Size	Rating	N° of Poles	Reference Number	Weight (kg)		Volume (cm) inc Packing
				Net	Gross	
B3	125A	3	9523 3012	6,0	9,3	585x385x310
		4	9523 4012	7,2	10,5	585x385x310
	160A	3	9523 3016	6,0	9,3	585x385x310
		4	9523 4016	7,2	10,5	585x385x310
	200A	3	9523 3020	6,0	9,3	585x385x310
		4	9523 4020	7,2	10,5	585x385x310
B4	250A	3	9523 3025	6,9	10,2	585x385x310
		4	9523 4025	7,0	11,0	585x385x310
	315A	3	9523 3031	7,0	10,3	585x385x310
		4	9523 4031	8,1	11,4	585x385x310
	400A	3	9523 3040	7,0	10,3	585x385x310
		4	9523 4040	8,1	11,4	585x385x310
B5	500A	3	9523 3050	11,7	15,0	585x385x385
		4	9523 4050	13,6	16,9	585x385x385
	630A	3	9523 3063	12,2	15,5	585x385x385
		4	9523 4063	14,3	17,6	585x385x385
B6	800A	3	9523 3080	27,9	43,9	730x800x600
		4	9523 4080	32,2	48,2	730x800x600
	1000A	3	9523 3100	28,4	44,4	730x800x600
		4	9523 4100	32,9	48,9	730x800x600
	1250A	3	9523 3120	28,9	44,9	730x800x600
		4	9523 4120	33,6	49,6	730x800x600
B7	1600A	3	9523 3160	33,1	49,1	730x800x600
		4	9523 4160	39,4	55,4	730x800x600
B8	2000A	3	9523 3200	50,7	66,7	730x800x600
		4	9523 4200	61,6	77,6	730x800x600
	2500A	3	9523 3250	50,7	66,7	730x800x600
		4	9523 4250	61,6	77,6	730x800x600
	3200A	3	9523 3320	61,0	77,0	730x800x600
		4	9523 4320	75,3	91,3	730x800x600

5.3.5. CE marking

The ATyS r complies with the European directive for:

- The Electromagnetic compatibility no. 2004/108/CE dated 15th of December 2004.
- Low voltage directive no. 2006/95/CE dated 12th of December 2006.



5.3.6. Lead free process

- The ATyS r complies with the European directive for RoHS.



5.3.7. WEEE

The ATyS r is built in accordance with 2002/96/CE directive:



5.3.8. EMC standard

The ATyS r is designed and built in accordance with IEC 60947-1 standards (Products intended to be installed in an «Industrial, Commercial and/or Residential Environment» therefore respecting both Class A as well as Class B EMC requirements).

DESCRIPTION	STD (IEC)	REQUIREMENT (CRITERIA)
Conducted	CISPR 11	Class B
Radiated	CISPR 11	Class B
ESD contact	61000-4-2	4KV (B)
ESD air	61000-4-2	8KV (B)
Electromagnetic field	61000-4-3	10V/m (A)
RF Conducted	61000-4-6	10V (A)
Burst	61000-4-4	2KV (B) power 1KV (B) control
Surge Common	61000-4-5	2KV (B)
Surge differential	61000-4-5	1KV (B)

5.4. ATyS r ACCESSORIES AVAILABLE

BRIDGING BARS

To connect switch I & II load terminals together.

TERMINAL SHROUDS (125 TO 630 A)

Incoming and outgoing protection against direct contact with the connection terminals or parts. Cannot be mounted in the rear position at the same time as the voltage sensing and power outlet kit or the bridging bars. Can be mounted top or bottom, in front or in rear position.

TERMINAL SCREENS

Incoming and outgoing protection against direct contact with the connection terminals or parts.

DOOR ESCUTCHEON PLATE

An accessory to be fixed onto a cabinet door to frame the controller part of flush mounted ATyS r transfer switches.

SUPPLEMENTARY AUXILIARY CONTACT (AC)

Pre-breaking and signaling of positions I and II: 1 additional auxiliary contact NO / NC auxiliary contact in each position. Included as standard for ratings from 2000 to 3200A. For Low level AC: please consult SOCOMEC.

KEY LOCK AUTO / MANUAL SELECTOR SWITCH

The ATyS r mode selector switch is delivered with a rotary handle as standard. This can be replaced with a key lock.

Download key lock assembly instructions for details.
Ref. 9599 1007.

RONIS KEY PADLOCKING ACCESSORIES

Locking of the electrical and manual operation by means of a RONIS EL11AP lock. Possibility of locking in all positions, if the "Padlocking in the 3 positions" option is ordered.

Not compatible with flush mounting.

PADLOCKING IN 3 POSITIONS

Allows locking of the operation in the 3 positions I, 0 and II.
(Factory fitted accessory)

DC POWER SUPPLY (DC -> AC)

Allows a standard 230Vac ATyS r to be supplied through a 12/24Vdc Aux Power supply. Available for ratings up to 1600A

CONTROL VOLTAGE TRANSFORMER

Allows a standard 230 V AC device to be supplied with 400 VAC.

Others:

Refer to the end of this instruction manual or the latest SOCOMEC product catalogue.

(Downloadable from www.socomec.com)

6. INSTALLATION

6.1. Product dimensions

6.1.1. Dimensions: Frame B3 to B5 (125A to 630A)

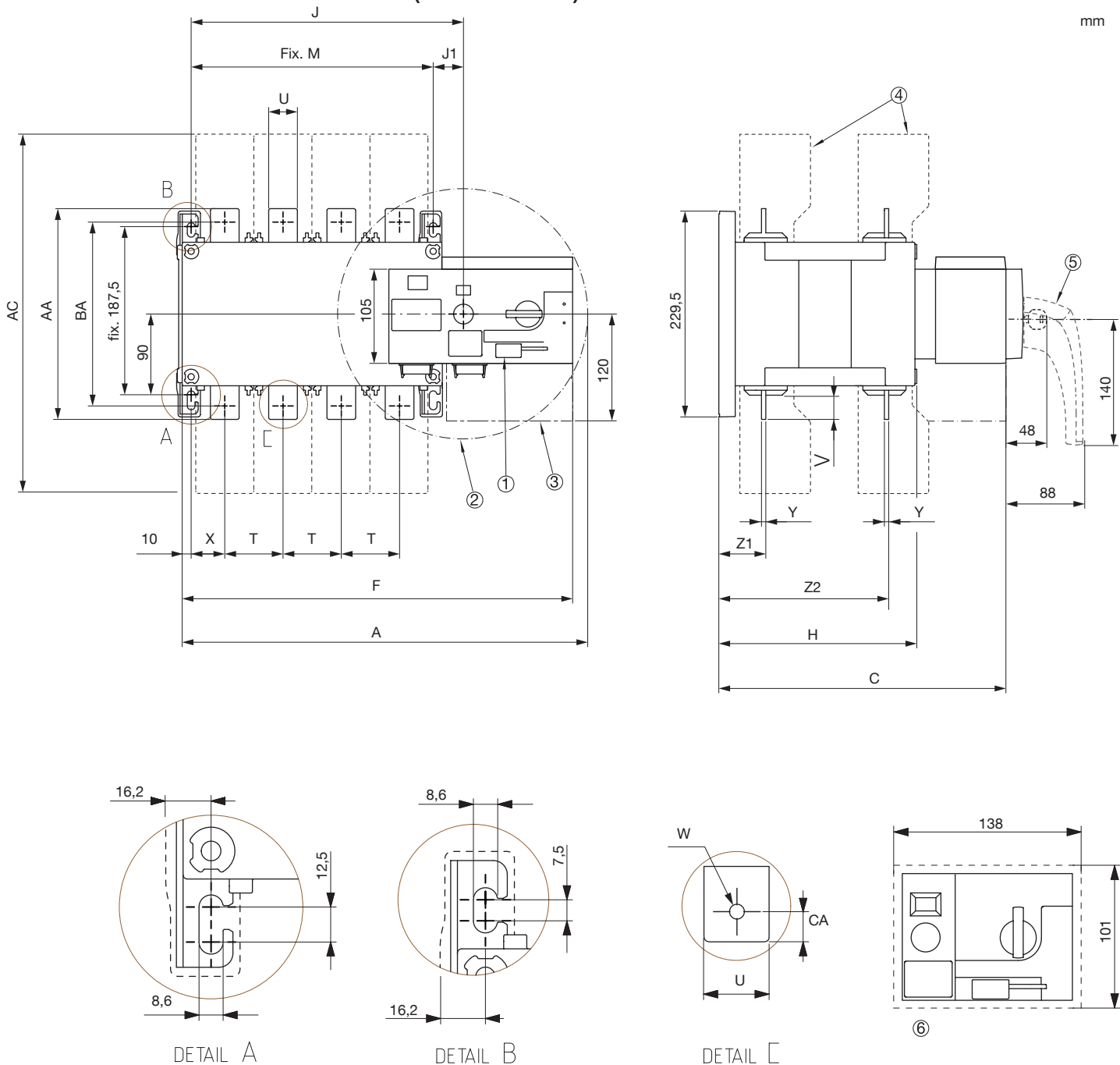

1. Padlocking Facility: Locking bracket for up to 3 padlocks of dia. 4 – 8mm
2. Emergency manual operation: Maximum operating radius with an operating angle of 2x 90°
3. Connection and disconnection area
4. Terminal shrouds
5. Emergency removable handle
6. Flush mounting cutout dimensions for front door



CAUTION

To consider the space required for manual operation and wiring.
(When using the ATyS r emergency handle: note 2).

	125 A		160 A		200 A		250 A		315 A		400 A		500 A		630 A	
	3 P	4 P	3 P	4 P	3 P	4 P	3 P	4 P	3P	4P	3P	4P	3P	4P	3P	4P
A	304	334	304	334	304	334	345	395	345	395	345	395	394	454	394	454
AA	135	135	135	135	135	135	160	160	170	170	170	170	260	260	260	260
AC	233	233	233	233	233	233	288	288	288	288	288	288	402	402	402	402
BA	115	115	115	115	115	115	130	130	140	140	140	140	220	220	220	220
C	244	244	244	244	244	244	244	244	244	244	244	244	321	321	321	321
CA	10	10	10	10	10	10	15	15	15	15	15	15	15	15	20	20
F	286,5	317	286,5	317	286,5	317	328	378	328	378	328	378	377	437	377	437
H	151	151	151	151	151	151	152	152	152	152	152	152	221	221	221	221
J	154	184	154	184	154	184	195	245	195	245	195	245	244	304	244	304
J1	34	34	34	34	34	34	35	35	35	35	35	35	34	34	34	34
M	120	150	120	150	120	150	160	150	160	210	160	210	210	270	210	270
T	36	36	36	36	36	36	50	50	50	50	50	50	65	65	65	65
U	20	20	20	20	20	20	25	25	35	35	35	35	32	32	45	45
V	25	25	25	25	25	25	30	30	35	35	35	35	50	50	50	500
W	9	9	9	9	9	9	11	11	11	11	11	11	14	14	13	13
X	28	22	28	22	28	22	33	33	33	33	33	33	42,5	37,5	42,5	37,5
Y	3,5	3,5	3,5	3,5	3,5	3,5	3,5	3,5	3,5	3,5	3,5	3,5	5	5	5	5
Z1	38	38	38	38	38	38	39,5	39,5	39,5	39,5	39,5	39,5	53	53	53	53
Z2	134	134	134	134	134	134	133,5	133,5	133,5	133,5	133,5	133,5	190	190	190	190

6.1.2. Dimensions: Frame B6 & B7 (800A to 1600A)

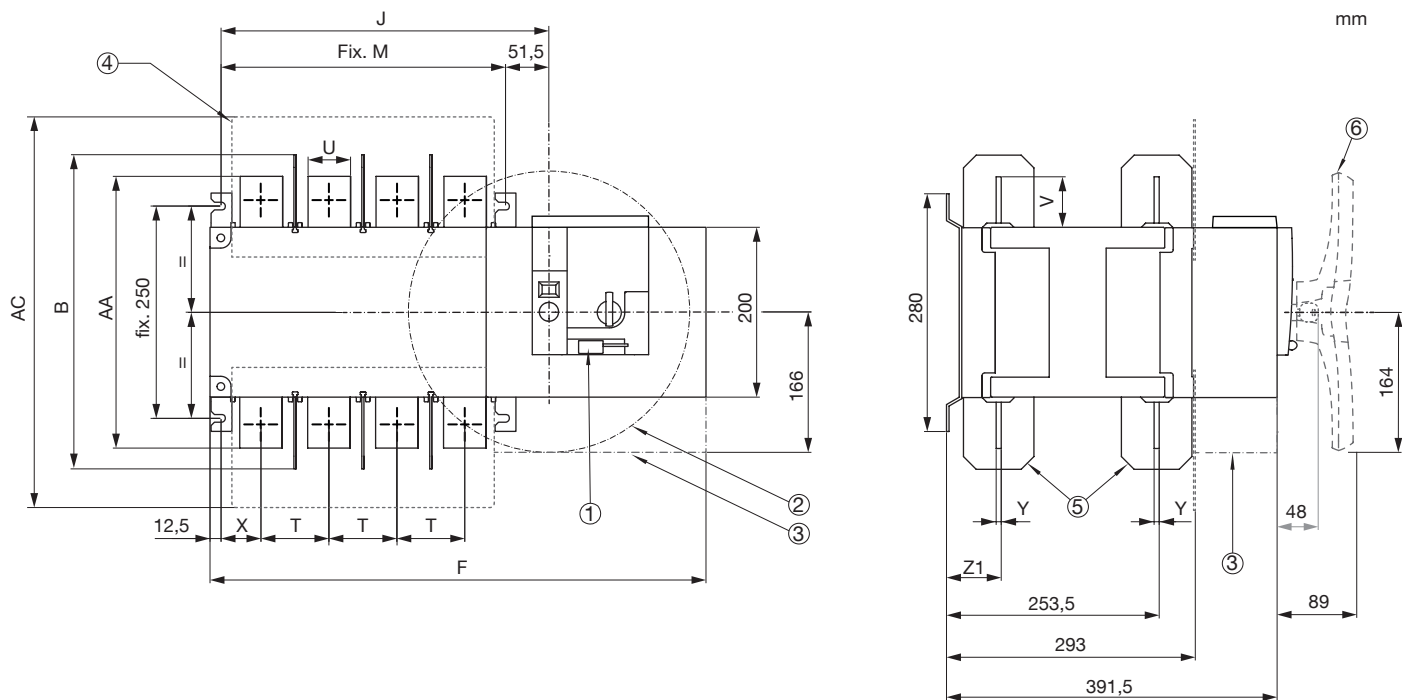

800 A - 1000 A

1250 A

1600 A - 3200 A

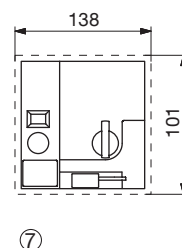
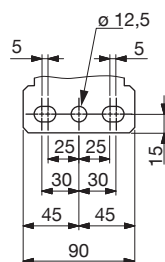
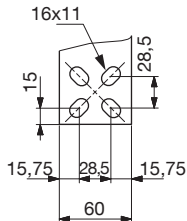
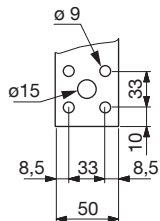
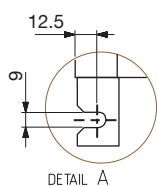

1. Padlocking Facility: Locking bracket for up to 3 padlocks of dia. 4 – 8mm
2. Emergency manual operation: Maximum operating radius with an operating angle of 2x 90°
3. Connection and disconnection area
4. Terminal screen
5. Phase Barriers
6. Emergency removable handle
7. Flush mounting cutout dimensions for front door

	800 A		1000 A		1250 A		1600 A	
	3P	4P	3P	4P	3P	4P	3P	4P
AA	321	321	321	321	330	330	288	288
AC	461	461	461	461	461	461	531	531
B	370	370	370	370	370	370	380	380
F	504	584	504	584	504	584	596	716
J	307	387	307	387	307	387	399	519
M	255	335	255	335	255	335	347	467
T	80	80	80	80	80	80	120	120
U	50	50	50	50	60	60	90	90
V	60,5	60,5	60,5	60,5	65	65	44	44
X	47,5	47,5	47,5	47,5	47,5	47,5	53	53
Y	7	7	7	7	7	7	8	8
Z1	66,5	66,5	66,5	66,5	66,5	66,5	67,5	67,5



CAUTION

To consider the space required for manual operation and wiring.
(When using the ATyS r emergency handle: note 2).

6.1.3. Dimensions: Frame B8 (2000A to 3200A)

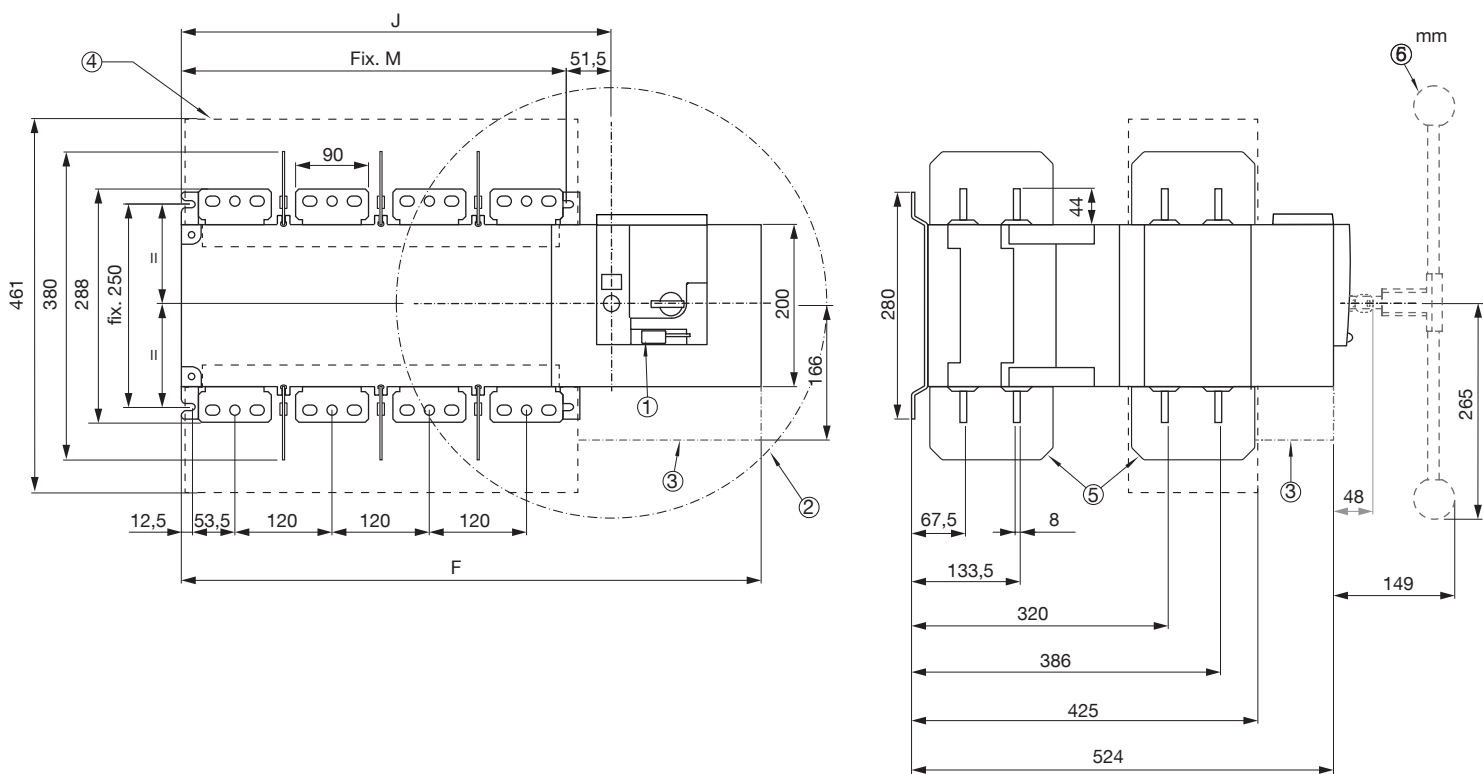

2000 A - 3200 A

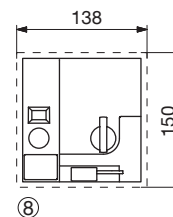
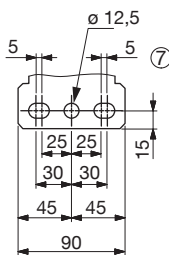
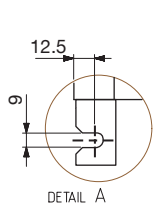

1. Padlocking Facility: Locking bracket for up to 3 padlocks of dia. 4 – 8mm
2. Emergency manual operation: Maximum operating radius with an operating angle of 2x 90°
3. Connection and disconnection area
4. Terminal shields
5. Phase Barriers
6. Emergency removable handle
7. Frame B8, (Dual frame) factory fitted power terminal connections
8. Flush mounting cutout dimensions for front door

	2000 A		3200 A	
	3P	4P	3P	4P
F	596	716	596	716
J	398,5	518,5	398,5	518,5
M	347	467	347	467



CAUTION

To consider the space required for manual operation and wiring.
(When using the ATyS r emergency handle: note 2).

6.2. Mounting orientation

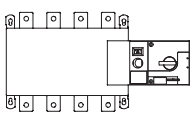
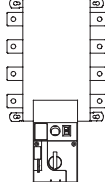
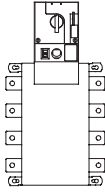
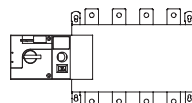
				
125A to 630A	Recommended	OK	Not Allowed	OK
800A to 3200A	Recommended	Not Allowed	OK	OK



CAUTION Always install the product on a flat and rigid surface.

6.3. Assembly of customer mounted accessories



DANGER Never handle any customer mounted accessories while there may be the risk of voltage being or becoming present.

6.3.1. Clip for emergency handle storage

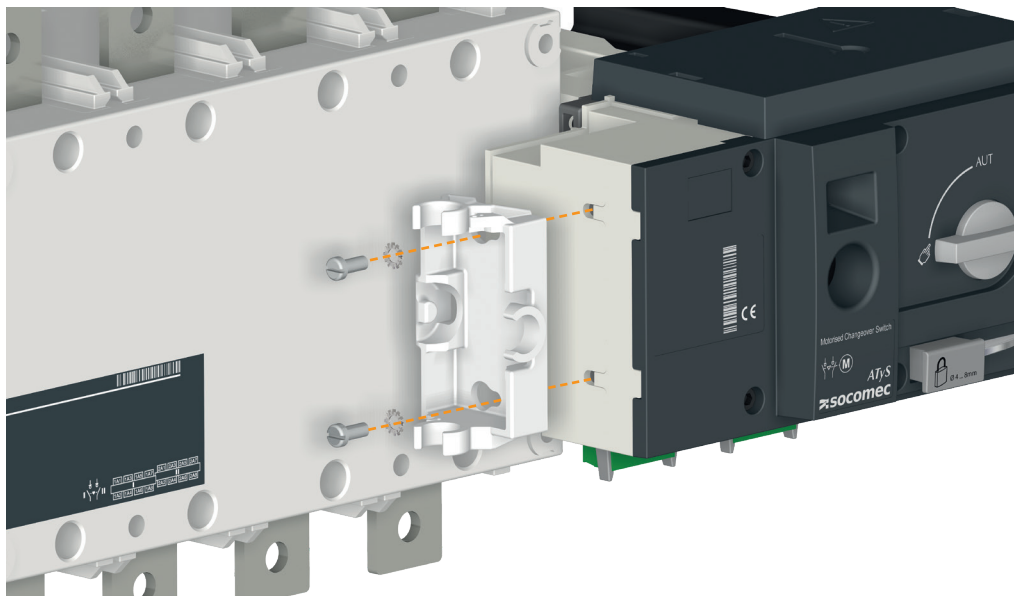

Max tightening torque 2,5 Nm

6.3.2. Bridging bar installation

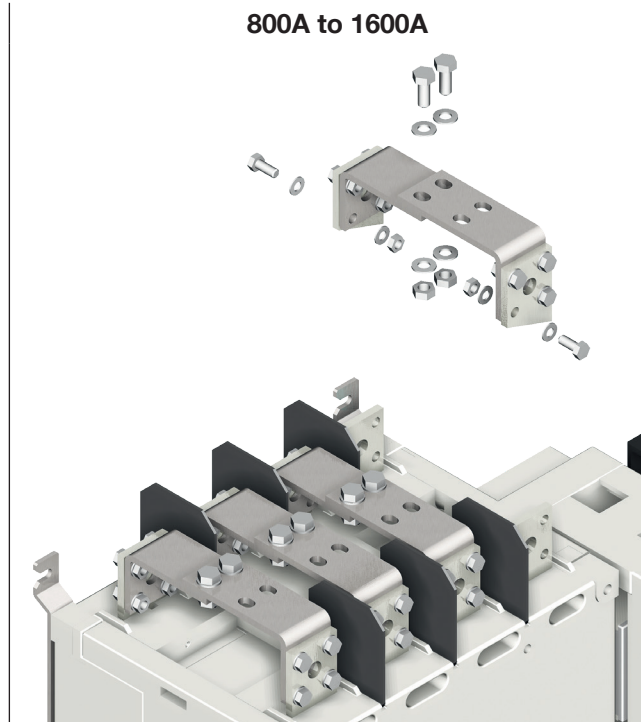
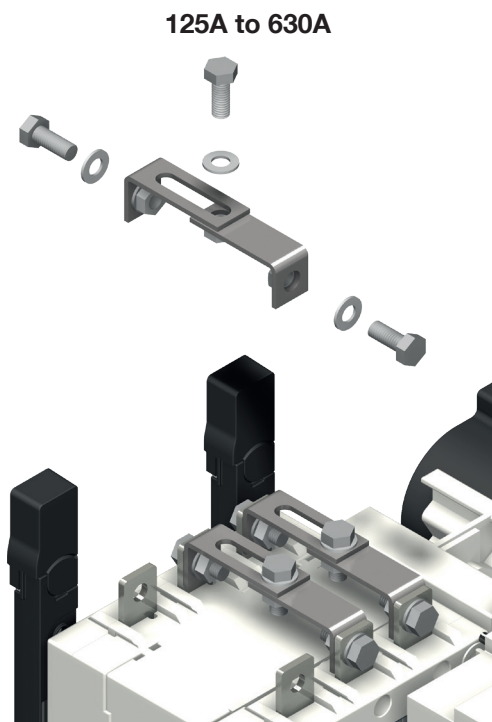

It is possible to mount the bridging bars on either side of the switch

Recommended tightening torque:

M6: 4,5 N.m
M8: 8,3 N.m
M10: 20 N.m
M12: 40 N.m

Maximum tightening torque:

M6: 5,4 N.m
M8: 13 N.m
M10: 26 N.m
M12: 45 N.m

6.3.3. Terminal shrouds

Available from 125A to 630A
Frame B3 to Frame B5:

- Upstream, downstream, front or rear mounting.
- When fitted with bridging bars only the front terminal shrouds are to be installed.

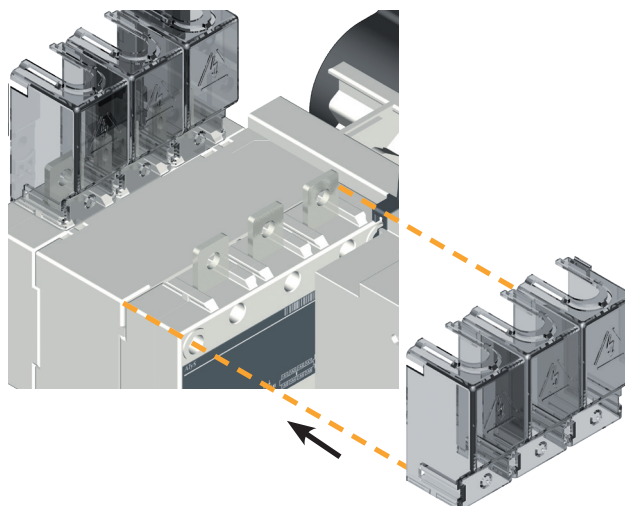

6.3.4. Terminal screens

125A to 630A

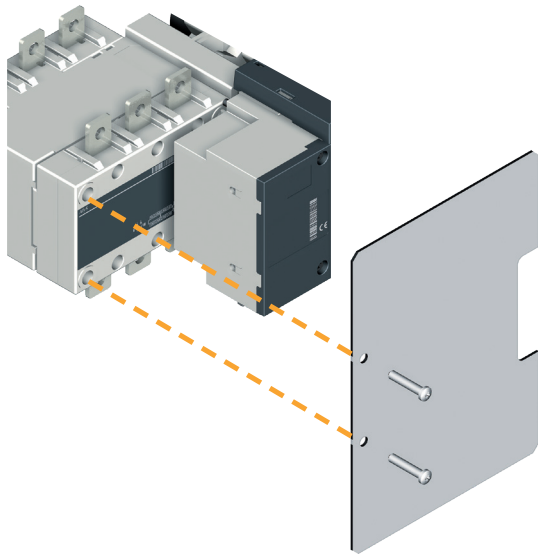

500A to 1600A

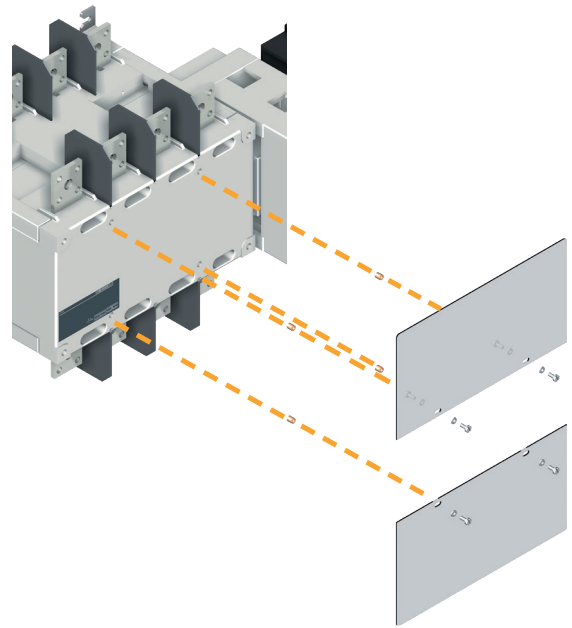

2000A to 3200A

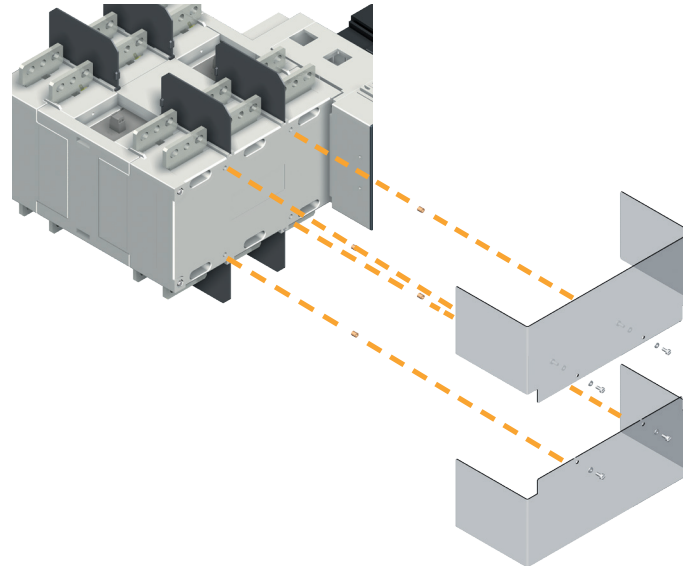

6.3.5. Copper bar connection kits (2000A to 3200A : Frame B8)

 Conditions of use of these products may lead to a derating.





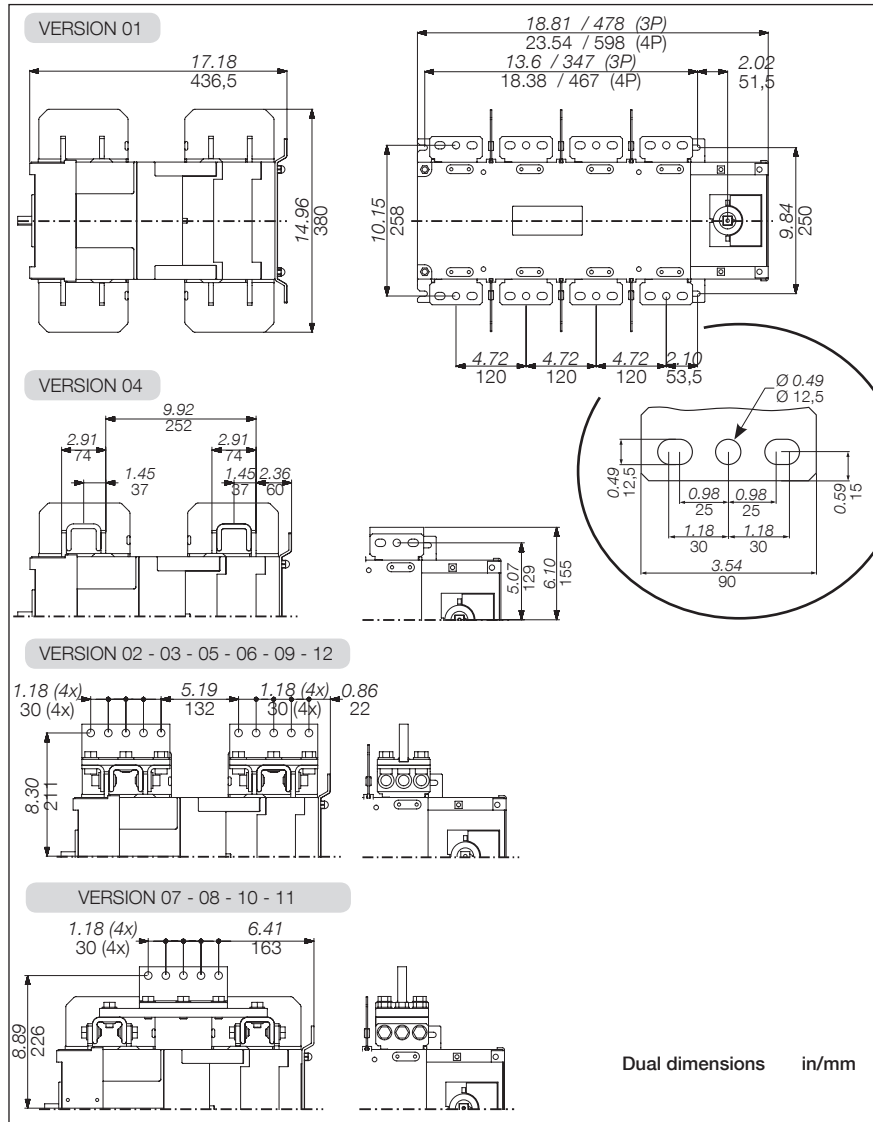
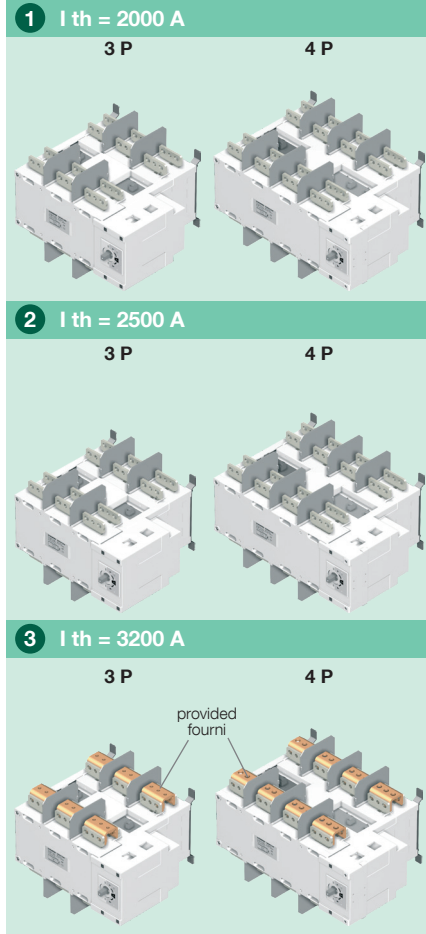



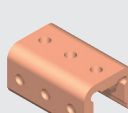

 SOCOMEC "Application guide"

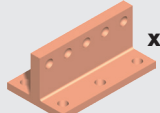

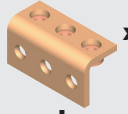
 www.socomec.com

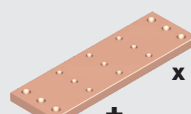

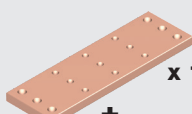
Data for Bolts, Nuts and Washers for Busbar Connections.

 TO BE SUPPLIED BY OTHERS

Connection reference numbers and contents:		
 x 1 included with 3200A product as standard 2619 1200	 x 6 708 lb-in 80 Nm 2699 1200 2699 1201	 x 1 +  x 6 708 lb-in 80 Nm 2629 1200
 x 2 +  x 6 708 lb-in 80 Nm 2639 1200	 x 1 +  x 6 708 lb-in 80 Nm 4109 0250	 x 1 +  x 6 708 lb-in 80 Nm 4109 0320

VERSION		 Rondelle contact MOY, M M12 NFE 25 511	 H M12
01	H M12-35 6.8 - 6 x	12 x	6 x
02	H M12-55 6.8 - 3 x	6 x	3 x
03	H M12-55 6.8 - 5 x	10 x	5 x
04	A M12-35 6.8 - 3 x	3 x	-
	B M12-45 6.8 - 3 x	3 x	-
05	H M12-65 6.8 - 3 x	6 x	3 x
06	H M12-65 6.8 - 5 x	10 x	5 x
07	H M12-55 6.8 - 3 x	6 x	3 x
08	H M12-55 6.8 - 5 x	10 x	5 x
09	H M12-55 6.8 - 10 x	20 x	10 x
10	H M12-65 6.8 - 3 x	6 x	3 x
11	H M12-65 6.8 - 5 x	10 x	5 x
12	H M12-65 6.8 - 10 x	20 x	10 x

Note: Reference numbers and quantity given above and below are for one connection and per pole.
For a full set multiply the quantity indicated by the number of poles (3 or 4 pole) and then multiply by 2 (N° of switches)

6.3.6. Incoming copper bar connection kit assembly

2000A – 2500A (MINIMUM CU BAR SECTION FOR ITH 2000A 3X100X5MM; AND FOR ITH 2500A 4X100X5MM)

VERSION 01

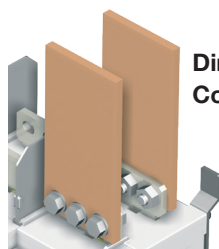

Direct Connection

VERSION 02

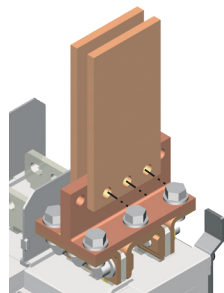

VERSION 03

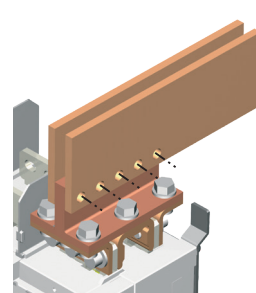

3200A (MINIMUM CU BAR SECTION 3X100X10MM)

VERSION 04

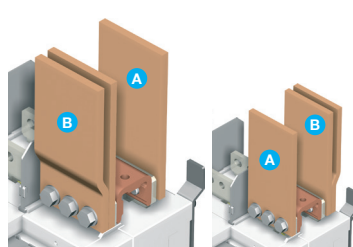

VERSION 05

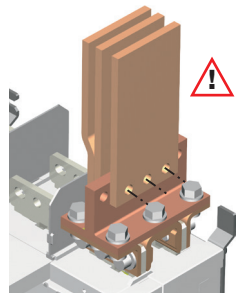

2900A Max

VERSION 06

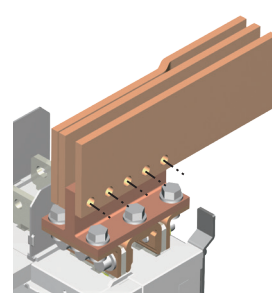

V2 & V3
 Kit :
 2619 1200 x 1
 2629 1200 x 1
 2639 1200 x 1

Connection bar 2619 1200 included with 3200A

V4
 Kit :
 2699 1200 x 1

V5 & V6
 Kit :
 2629 1200 x 1
 2639 1200 x 1

6.3.7. Outgoing bridge connection assembly

2000A – 2500A (MINIMUM CU BAR SECTION FOR ITH 2000A 3X100X5MM; FOR ITH 2500A 4X100X5MM)

VERSION 07

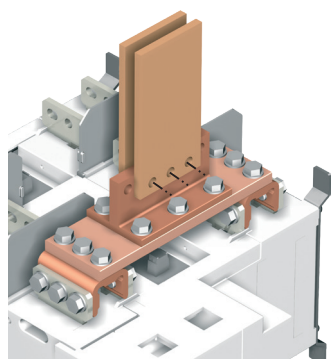

VERSION 08

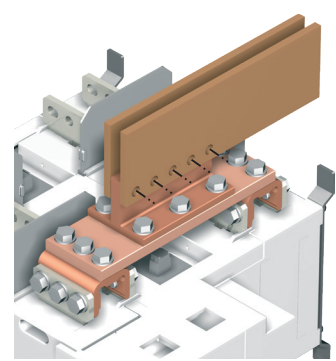

VERSION 09

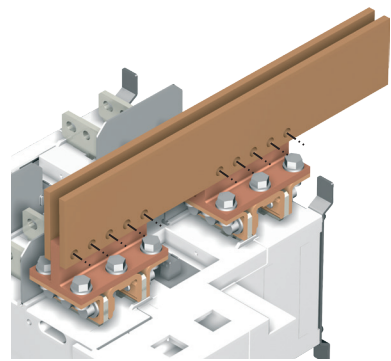

3200A (MINIMUM CU BAR SECTION 3X100X10MM)

VERSION 10

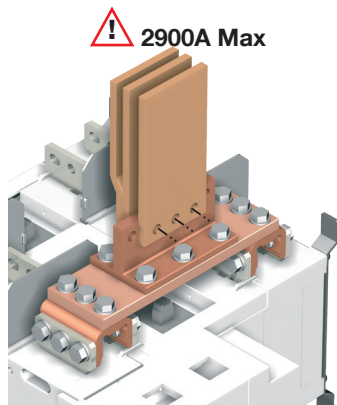

2900A Max

VERSION 11

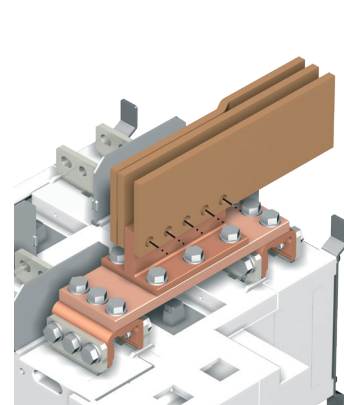

VERSION 12

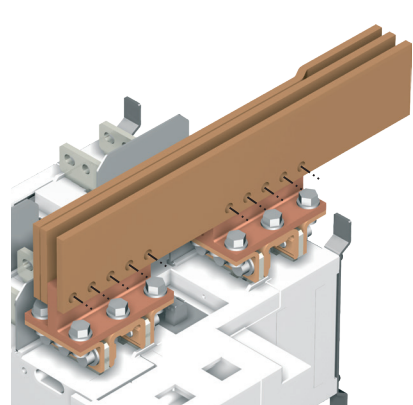

V7 & V8
 Kit :
 2619 1200 x 2
 2699 1201 x 2
 2629 1200 x 1
 4109 0320 x 1

V9
 Kit :
 2619 1200 x 2
 2629 1200 x 2
 2639 1200 x 2

Connection bar 2619 1200 included with 3200A

V10 & V11
 Kit :
 2699 1201 x 2
 2629 1200 x 1
 4109 0320 x 1

V12
 Kit :
 2629 1200 x 2
 2639 1200 x 2

6.3.8. External Power supply

6.3.8.1. 400VAC - 230VAC Power Supply

Power Transformer intended for 400VAC, Phase to Phase voltage applications that do not provide the availability of a neutral conductor. Transformer data: 400VAC – 230VAC: 200VA.

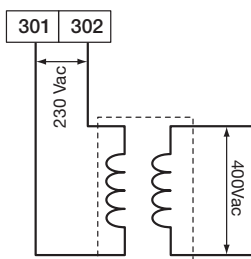

6.3.8.2. 12-24VDC Power Supply

DC power supply available in 12Vdc as well as 24Vdc intended to allow a standard ATyS r (125-1600A) to be powered from an appropriate DC supply. (Usually the battery of the backup generator source).

This converter is to be positioned as close as possible to the DC power source.

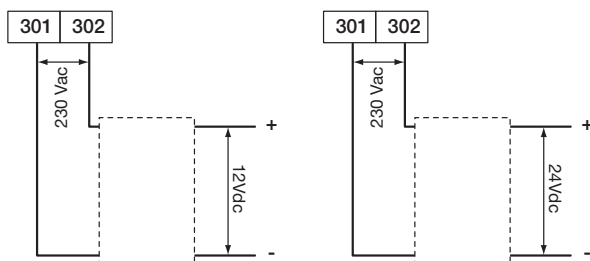

6.3.9. Padlocking key interlocks

Intended for locking the electrical control and the backup control in position 0 using a RONIS EL11AP lock. As standard, key locking is in the 0 position.

Optionally and when including the option “padlocking in 3 positions” key locking will be in positions I, 0 or II

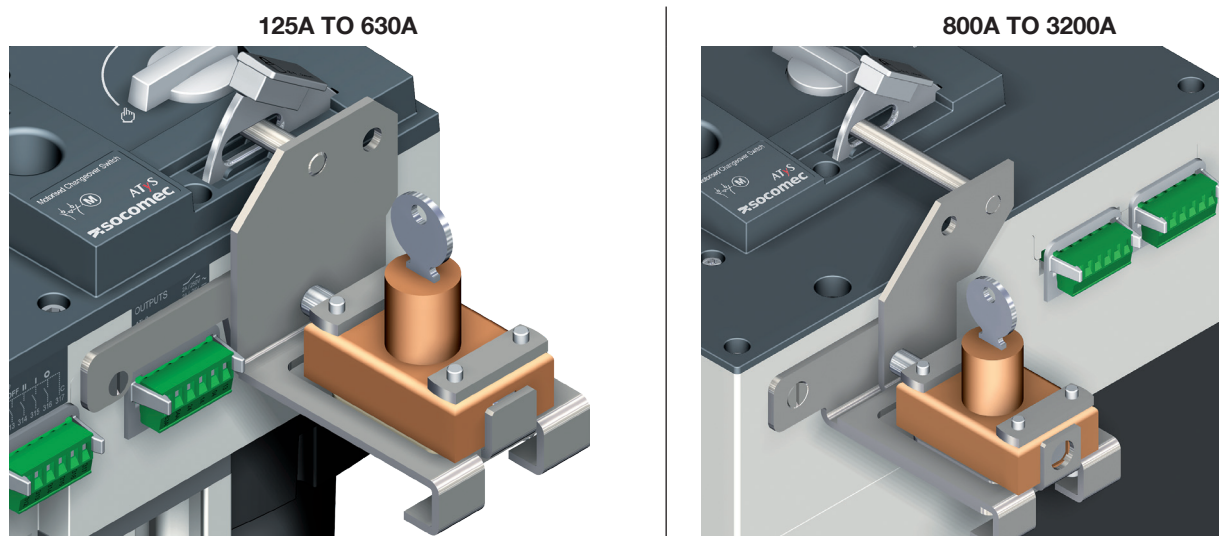

6.3.10. Additional auxiliary contacts

Intended for pre breaking and signaling of positions I and II:

A maximum of 2 NO/NC additional auxiliary contacts can be fitted for each position. (Customer assembly may be required.)

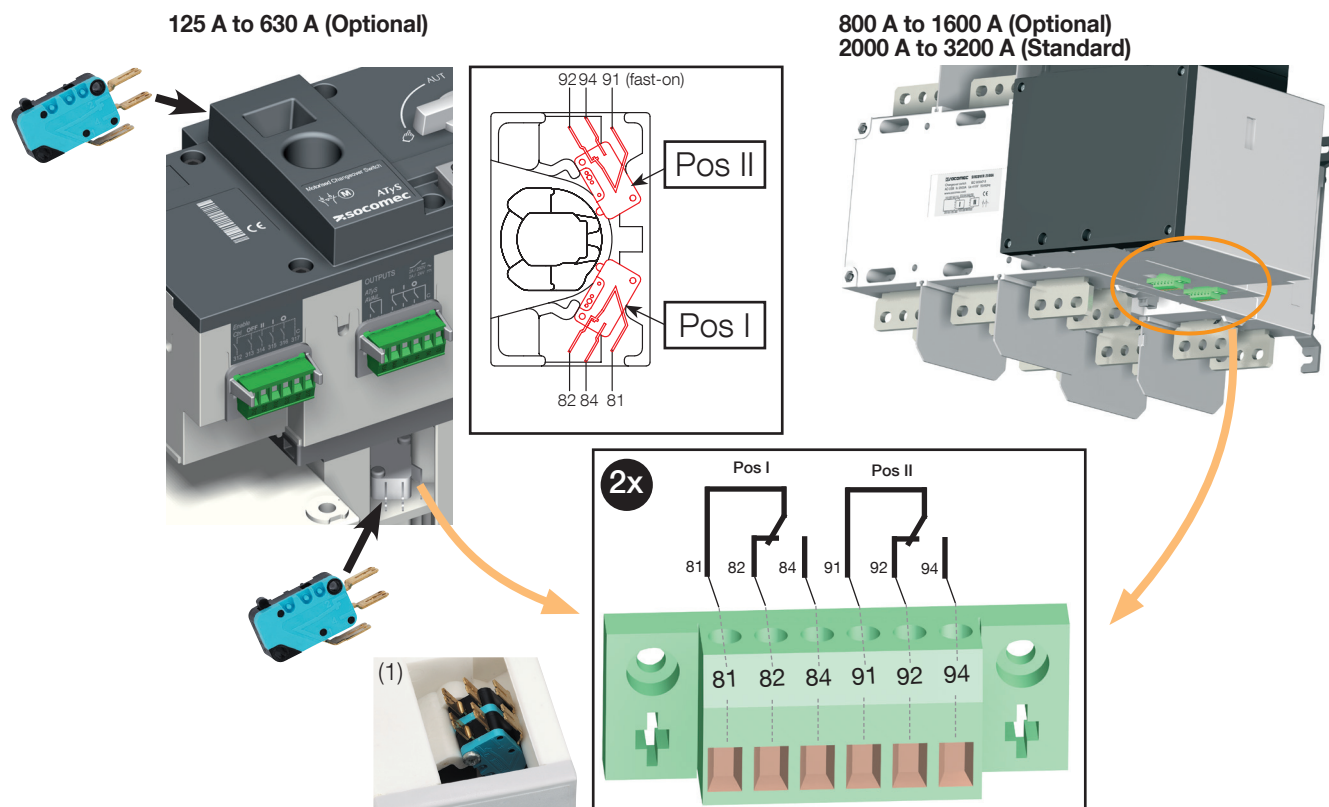

(1) When mounting one auxiliary contact on position I or II, use the short screws provided. When mounting two auxiliary contacts on position I or II, use the long screws provided.

7. CONNECTIONS

7.1. Power circuits

7.1.1. Cable or bar connections

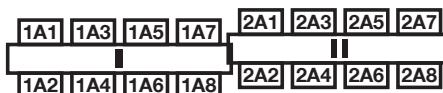
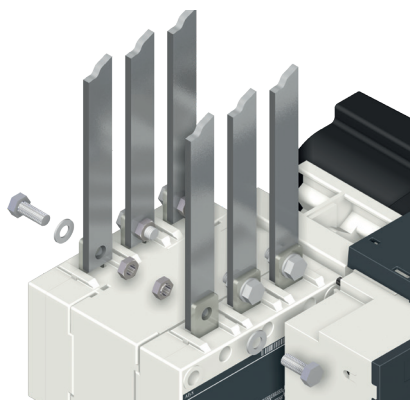

Recommended tightening torque:

- M6: 4,5 N.m
- M8: 8,3 N.m
- M10: 20 N.m
- M12: 40 N.m

Maximum tightening torque:

- M6: 5,4 N.m
- M8: 13 N.m
- M10: 26 N.m
- M12: 45 N.m



CAUTION

For B3 (8kV)

- Terminations must respect a minimum of 8 mm clearance from live parts to parts intended to be earthed and between poles

For B4,5,6,7,8 (12kV)

- Terminations must respect a minimum of 14 mm clearance from live parts to parts intended to be earthed and between poles

7.1.2. Power connection terminals

125A TO 630A

Refer to section "Product dimensions", page 20 for power connection terminals up to 630A.

800A TO 1000A

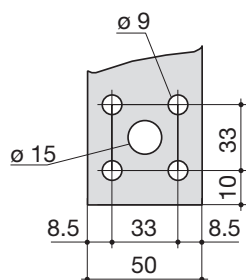

svr_077_a_1_x_cat

1250A

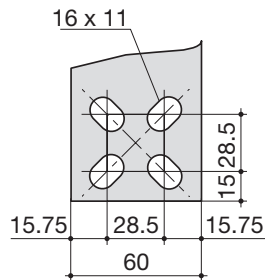

svr_078_b_1_x_cat

1600A TO 3200A

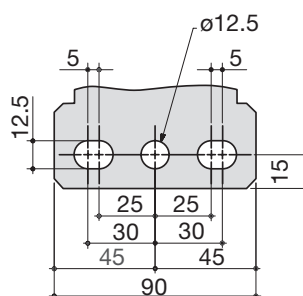

7.1.3. Power connection cross-section

	B3			B4			B5		B6			B7	B8		
	125A	160A	200A	250A	315A	400A	500A	630A	800A	1000A	1250A	1600A	2000A	2500A	3200A
Minimum cables section Cu (mm ²), lth	50	70	95	120	185	240	2x150	2x185	2x240	-	-	-	-	-	-
Minimum bars section Cu (mm ²), lth	-	-	-	-	-	-	2x30 x5	2x40 x5	2x50 x5	2x63 x5	2x80 x5	2x100 x5	3x100 x5	2x100 x10	3x100 x10
Maximum cables section Cu (mm ²)	50	95	150	150	240	240	2x300	2x300	2x300	4x185	4x185	6x185	-	-	-
Maximum bars width Cu (mm)	25	25	25	32	32	32	50	50	63	63	63	100	100	100	100

Note for all ratings: Take into account the connection cable lengths and/or others environmental specific operating conditions.

7.2. Control circuits

7.2.1. Typical ATyS r wiring

Example: Control wiring for a 400VAC application having a 3 phase and neutral supply.

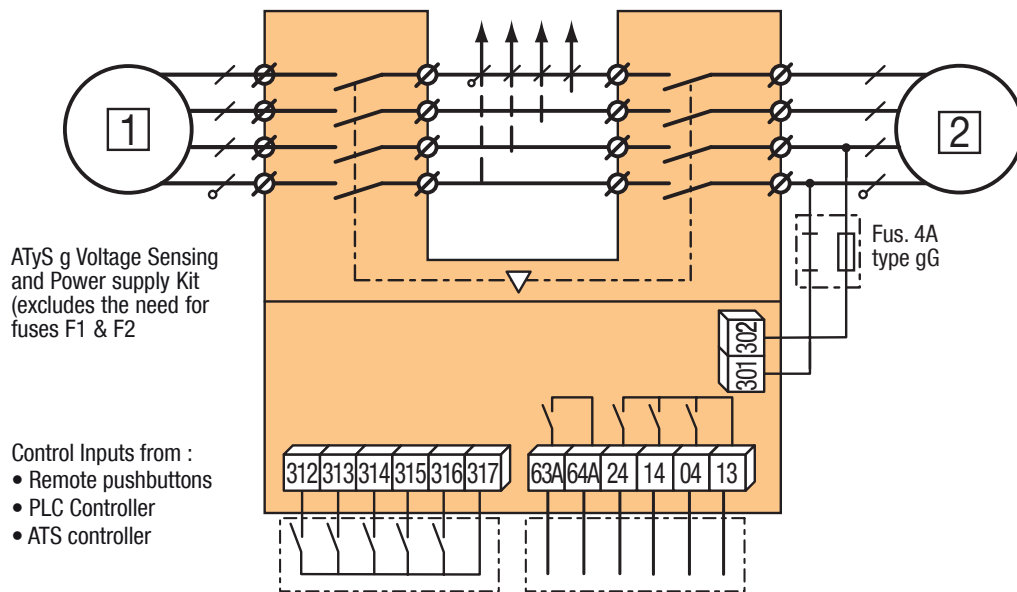

DANGER

Do not handle any control or power cables connected to the ATyS when voltage may be present.



CAUTION

Verify that the Auxiliary power supply feeding terminals 301 and 302 are within the limits of 208VAC -> 277VAC $\pm 20\%$ (166-332VAC).

7.2.2. ATyS r RTSE + ATS Controllers type ATyS C25 and ATyS C55/C65

Refer to the relevant ATS controller instruction manual for ATyS C25 and ATyS C55/65 details

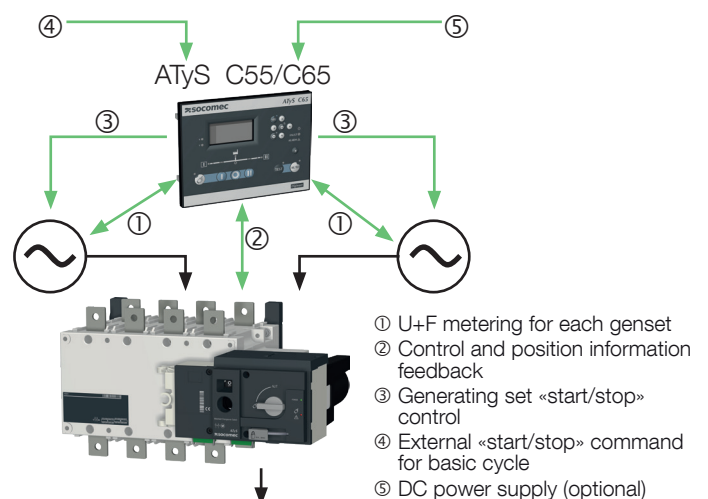
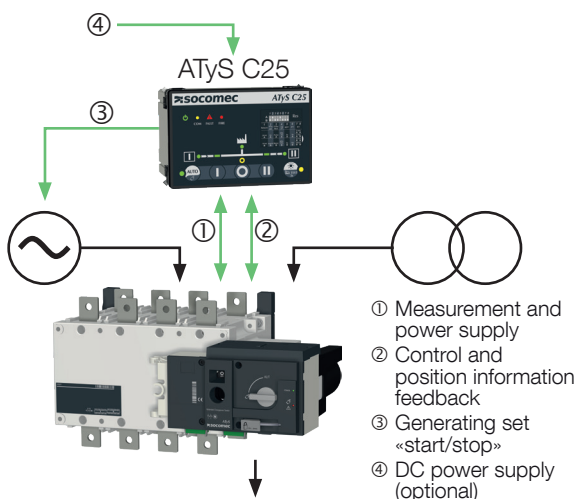

7.2.3. ATyS r input and output contacts

7.2.3.1. Terminal denomination, description and characteristics.

Power I/P L: 301
Power I/P N: 302

301 302
L N
Aux. supply
230V 50/60Hz
208-277V~ ±1-20%

⚠ All pressure on the connector pins is to be avoided during wiring of the auxiliary cables

CONTROL

Enable
Ctrl OFF II I O
312 313 314 315 316 317

Control Enable: 312
Override to OFF: 313
Sw to Pos II I/P: 314
Sw to Pos I I/P: 315
Sw to Pos 0 I/P: 316
Common: 317

Prod Avail Common 63A
Prod Avail O/P: 64A
Pos II Aux Contact: 24
Pos I Aux Contact: 14
Pos 0 Aux Contact: 04
Common: 13

OUTPUTS

ATyS AVAIL.
63A 64A 24 14 04 13 C

2A / 250V ~
2A / 24V ~

DENOMINATION	TERMINAL	DESCRIPTION	CHARACTERISTICS	RECOMMENDED CABLE SECTION
SIGNALISATION OUTPUTS	13	Common I - 0 - II for Aux Contacts	Dry Contacts 2A AC1 / 250V	1.5mm ²
	04	Aux Contact Position 0 - Normally Open Contact		
	14	Aux Contact position I : Normally Open Contact		
	24	Aux Contact position II : Normally Open Contact		
	63A	Product Available : Normally Open Contact. Closed when the ATyS r is in Auto mode and motorisation is operational. (No Fault powered and ready to changeover)		
	64A			
ADDITIONAL AUX CONTACT INCLUDED WITH 2000A TO 3200A OPTIONAL FOR 800A TO 1600A	81	Common for Aux Contacts positions I	Dry Contacts 2A AC1 / 250V	1.5 – 2.5mm ²
	82	Aux Contact position I: Normally Closed Contact		
	84	Aux Contact position I: Normally Open Contact		
	91	Common for Aux Contacts positions II		
	92	Aux Contact position II: Normally Closed Contact		
	94	Aux Contact position II: Normally Open Contact		
POWER SUPPLY INPUT	301	Power supply – L	208 - 277VAC ± 20% : 50/60Hz	1.5mm ²
	302	Power supply – N		
CONTROL INPUTS	312	Remote Control Mode Enable when closed with 317	Attn: Do not connect to any Power supply Max cable length 100m	1.5mm ²
	313	Position 0 order if closed with 317. (Priority order input forcing the product to remote control mode and 0 position)		
	314	Position II order if closed with 317		
	315	Position I order if closed with 317		
	316	Position 0 order if closed with 317		
	317	Common control terminal for 312 - 316 ATyS r (Specific Voltage Supply)		



CAUTION





Do not connect terminals 312 to 317 to any power supply. These order inputs are powered through terminal 317 and external dry contacts ONLY.

8. ATyS R OPERATING MODES

The ATyS r includes 3 safe and distinct operating modes through a selector switch located on the front of the product. As standard the ATyS r is delivered with a selector switch however a key lock type selector switch is available on option. (To be specified at order by the addition of “-K” at the end of the standard reference).

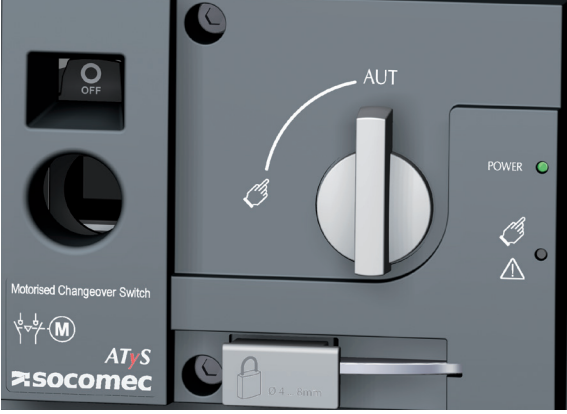
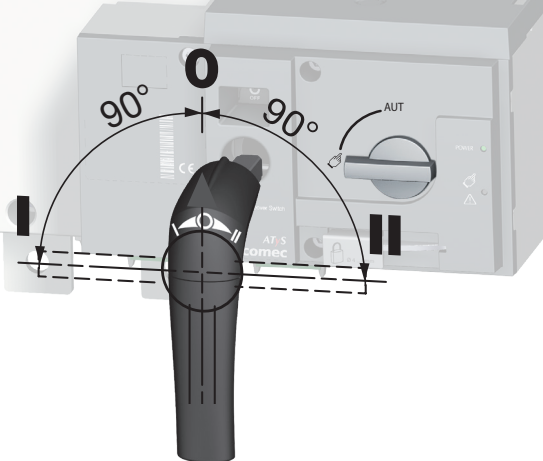
The modes of operation are as follows:

- Auto Mode: “Remotely operated transfer switching”
- Manual Mode: “Local emergency manual operation”
- Locked Mode: “Secure locked padlocking facility”

<p>AUT MODE</p>		<p>AUT</p> <p>AUTO MODE:</p> <ul style="list-style-type: none"> • Activates the remote control inputs and the ATS controller automation. • Inhibits the padlocking facility • Inhibits the insertion of the manual operation handle when in AUT Mode <p>AUTO Mode position is inhibited when padlocked or when the handle for manual operation is inserted into the ATyS r.</p>
<p>MODE</p>		<p>AUT</p> <p>MANUAL MODE: (Not Padlocked)</p> <ul style="list-style-type: none"> • Inhibits the control inputs. • Allows to insert the handle for emergency manual operation. • Allows padlocking in O Position. <i>(With the handle for manual operation removed)</i> <p>Turning the selector switch to  from AUT and back to AUT resets a fault state.</p>
<p>MODE</p>		<p>AUT</p> <p>MANUAL MODE: (Padlocked)</p> <ul style="list-style-type: none"> • Inhibits the control inputs. • Inhibits insertion of the emergency handle. • Allows padlocking when in O Position. <p> POS 0</p> <p>Padlocking in position I - O and II is possible when the optional function is included in the ATyS r. (Refer to product catalogue)</p>



WARNING

Depending on the state of the ATyS r the ATS automation may change the switch position as soon as the mode selector is switched to AUT. This is a normal operation.

8.1. Manual operation

8.1.1. Emergency manual operation

The ATyS r can be manually operated as a “Manual Transfer Switch Equipment – MTSE” whilst retaining the electrical characteristics and performance of the power switching function. This function is usually used in case of emergencies or during maintenance.

To operate the ATyS r manually ensure that no live parts are accessible, turn the front selector switch into the manual position (see page 14) and insert the handle (see page 14) into the emergency handle shaft location hole provided (see page 15).

Turn the handle 90° clockwise or anti-clockwise (depending on the position to be reached) for each consecutive change in position. I -> O -> II -> O -> I.

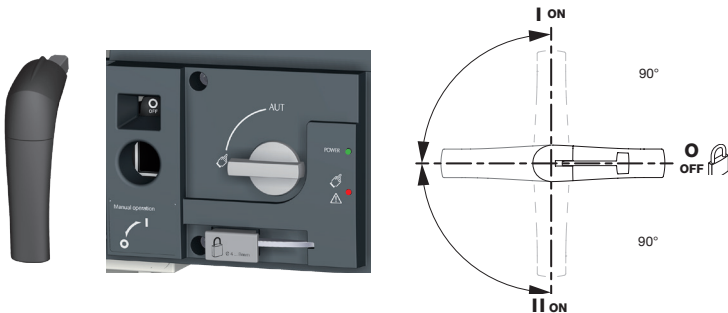

CAUTION

Ensure to verify the product position and direction of rotation before effecting manual operation.

Ensure to remove the handle from the product before changing the selector switch back to AUT position.

8.1.2. Padlocking

The ATyS r can be padlocked in the O position as standard whilst padlocking in positions I, O or II is available as a factory fitted option.

To padlock the ATyS r first ensure that the ATyS r mode selector switch is on Manual then ensure that the emergency manual operation handle is not inserted into the location hole. (Remove if inserted).

Pull the padlocking mechanism outwards to reveal the slot for inserting up to 3x dia. 4 - 8mm padlocks.

Padlock the device with approved quality padlocks of minimum diameter 4mm and maximum diameter of 8mm. A maximum of 3x 8mm padlocks may be padlocked onto the ATyS r to padlocking mechanism.



CAUTION

As standard, padlocking is only made possible in the “O position”, when in manual mode and with the emergency handle not inserted.

8.2. Electrical operation

8.2.1. Power supply

The ATyS r is to be powered between terminals 301 and 302 with a supply within the limits of :

- 208 – 277Vac $\pm 20\%$ (166 – 332Vac)
- 50/60Hz $\pm 10\%$

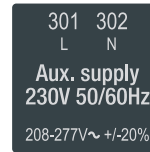

Current Input:

- 10mA (Standby mode)
- 15A max (Switching mode)

Surge Protection :

- V_{in_sg} : 4.8KV – 1.2/50 μ s

Terminal connector:

- Minimum 1.5mm²
- Maximum 2.5mm²

8.2.2. Fixed inputs

8.2.2.1. Description

The ATyS r includes for 5 off fixed inputs through a 6 pin connector installed on the motorisation module. No additional power supply should be used on these contacts as the inputs **MUST** be used with the common supply taken from terminal 317.

The ATyS r Power Supply (301 - 302) must be available to activate inputs 312 to 317.

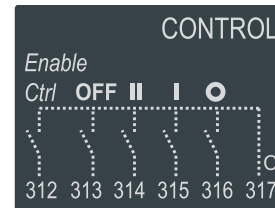

Pulse duration for activation of contact inputs: ≥ 60 ms.

- **Pin 312:** Remote Control Mode Enable when closed with 317.

This contact must be closed with 317 so as to activate all control inputs except for 313 that takes priority and is active immaterial of the state of input 312. Enabling remote control through 312 activates the remote control inputs whilst inhibiting the ATS module automation.

- **Pin 313:** Position 0 order if closed with 317 when in AUTO. **(Force the switch to the OFF Position)**

This is a **“Priority Order Input”** meaning that when closed with 317 it takes priority over all other electrical commands. The ATyS r will remain in 0 position as long as the contact 313 – 317 remains closed. Once the contact is open the ATyS r is ready to receive new orders. This contact order is independent of other inputs and is also enabled without 312 connected to 317. Impulse duration to activate and start switching to position O is a minimum of 60ms. The product state will be unavailable.

- **Pin 314:** Position II order if closed with 317.

This contact is active with the ATyS r in AUT mode with contact 312 – 317 closed and 313 – 317 open. Impulse duration to activate and switch to position II is a minimum of 60ms.

- **Pin 315:** Position I order if closed with 317

This contact is active with the ATyS r in AUT mode with contact 312 – 317 closed and 313 – 317 open. Impulse duration to activate and switch to position I is a minimum of 60ms.

- **Pin 316:** Position 0 order if closed with 317

This contact is active with the ATyS r in AUT mode with contact 312 – 317 closed and 313 – 317 open. Impulse duration to activate and switch to position O is a minimum of 60ms. For contactor logic maintain contacts on between terminal 316 and 317.

- **Pin 317:** Common

Common supply for inputs 312 to 316

8.2.2.2. Technical data

MOTORISATION MODULE	
Input Qty	5
Direct Current lin	0.35 to 0.5mA
Line resistance	1kΩ
Line length	100m (Min. wire 1.5mm ² #16AWG)
Pulse duration	60ms
Power per Input	0.06VA
Surge protection Vin_sg	4.8kV (1.2/50μs surge)
ESD withstand voltage (Contact/air)	2/4kV
Insulation (Common mode)	4.8kVAC (Between I/P and all common parts)
Terminal connector	1.5mm ² minimum / 2.5mm ² max

8.2.2.3. Remote control logic

Remote switching operation can be driven in AUT mode by external volt free contacts as described above using input contacts 312 to 317.

Depending on the wiring configuration there are two types of logic that may be applied to the ATyS r.

- Impulse logic or
- Contactor logic.

In remote control, the ATyS r inputs give priority to orders I and II over 0 therefore contactor logic can be implemented by simply bridging terminals 316 and 317.

(NOTE: 312 – 317 closed / Force ATyS r to OFF Position, takes priority over all other orders no matter of the control logic used.)

<p>Impulse logic:</p> <p>The ATyS r is driven to a stable position (I – O – II) after receiving an impulse order.</p> <ul style="list-style-type: none"> • A switching command of at least 60 ms is necessary to initiate the switching operation. • Orders I and II have priority over order 0. <p>Note: The logic diagrams exclude the transfer times.</p>	<p style="text-align: center;">Impulse logic</p>  <p style="text-align: center;">(Note : Excludes position switching delays)</p>
<p>Contactor Logic :</p> <p>The ATyS r is driven to a specific position (I or II) for as long as the order is maintained.</p> <ul style="list-style-type: none"> • Order 0 is maintained. (Bridge 316 – 317) • Orders I and II have priority over order 0. • Orders I and II have equal priority. (1st order received is held until no longer maintained). • If order I or II disappears, the device returns to zero position. (With the power supply available). 	<p style="text-align: center;">Contactor logic</p>  <p style="text-align: center;">(Note : Excludes position switching delays)</p>

8.2.3. Fixed outputs - Dry contacts

8.2.3.1. Description

As standard, the ATyS r is equipped with four fixed outputs located on the motorisation module.

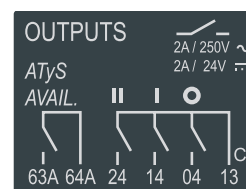

(Dry contacts to be powered by the user).

8.2.3.2. Position auxiliary contact

The ATyS r is equipped with integrated position (I – O – II) auxiliary contact outputs through 3 off micro switches.

Pins 13, 04, 14, 24

(Normally Open contacts with pin 13 as common)

8.2.3.3. ATyS r Product available output (motorisation)

Pin 63A – 64A

(Normally Open contact that is held closed when the motorisation is available).

This contact gives constant feedback about the product's availability and it's capacity to transfer from the main supply to the alternative. The feedback given is relative to the motorisation module excluding the ATS controller that may be monitored separately.

The ATyS r performs a self diagnostics test on the motorisation module at startup, when put from Manual -> Auto and then every 5 minutes. This test ensures that the ATyS r is operational in terms of control inputs. Should one of the tests fail, a second test is performed to reconfirm the error state. Should the ATyS r motorisation module become unavailable, contact 63A – 64A are opened, the power/ready LED's are switched off, and the fault LED is activated. The fault LED will remain active for as long as sufficient power is available and the fault condition is not reset. The fault is reset when the product is switched from AUT -> Manual -> Auto mode.

ATyS r (Motorisation) Product Available / Unavailable Watchdog relay will open for any of the following reasons below: For added security, "Product Availability" is informative and does not necessarily inhibit motor operation.

Product Unavailable + Warning LED Condition:	Inhibition
Product in manual mode	Yes
Motor not detected (Autotest)	No
Control voltage out of range	Yes
Operating factor fault active (N° of operations / min)	Yes
Powerfail active	Yes
Customer input autotest failed	No
Invalid product customisation	No
Abnormal switching when not in manual mode	Yes
Requested position not reached	Yes
Locked mode active when not in manual mode	Yes
External Fault -> User input	No
Unexpected current flowing through the motor when idle	Yes

Sampling rate for the above is every 10 ms

Exception: motor detection sampling rate is every 5 min

8.2.3.4. Technical data

Auxiliary Contact Quantity	4
Configuration	NO
Mechanical Endurance	100k cycles
Response Time	5 – 10 ms
Startup duration	200ms
Rated Voltage / Switching Voltage	250VAC
Rated Current	2A
Surge protection Vin_sg:	4.8kV (1.2/50µs surge)
ESD withstand voltage (Contact/air):	2/4kV
Dielectric Strength contact/parts:	4.8kVAC (Reinforced Insulation)
Insulation:	4.8KVAC
Output Terminal:	1.5mm ² minimum / 2.5mm ² maximum

8.3. Operating Sequences

The given times are: operating transfer time, product opening time and contact transfer time. The definitions of these times are given below:

1. Operating transfer time (OTT) – IEC 60947-6-1 §3.2.6

This time is measured from the instant the monitored supply deviates (not considered as available anymore) to the closing of main contacts on an available alternative supply source, exclusive of any purposely introduced time delay. In other words, this is the global transfer time, excluding all programmable delays (timers configured to 0).

If the supply deviation is not monitored by the product itself, but by an external controller, OTT time starts when the order is received by the product.

2. Product opening time I-0 or II-0 (POT)

This time is measured from the instant that the monitored supply is not considered as available to the opening of the main contacts, exclusive of any purposely introduced time delay. If the product is controlled via external orders, this time is measured from the moment when the order is received to the opening of the main contacts.

3. Contact transfer time (CTT) – IEC 60947-6-1 §3.2.5

This time is measured from the parting of one set of main contacts from one power supply to the closing of a second set of main contacts on an alternative power supply; this is the duration between the opening of the contacts on the initial position and the closing of the contacts on the position reached, in other words, it is the time in 0 (disconnection time).

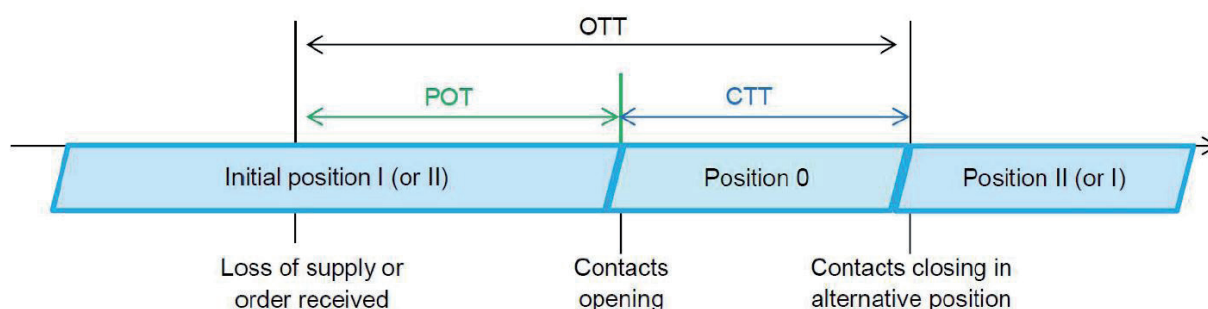

Mean switching times at nominal voltage and frequency – 25°C:

	125 A 160 A 200 A	250 A 315 A 400 A	500 A 630 A	800 A 1000 A 1250 A	1600 A	2000 A 2500 A 3200 A
Contact transfer time ("electrical blackout") I-II - CTT	0.4s	0.4s	0.4s	1.4s	1.4s	1.1s
I-0 or II-0 following an order - POT	0.54s	0.56s	0.56s	1.4s	1.4s	1.3s
Operating transfer time I-II or II-I, following an order - OTT	0.94s	0.96s	0.96s	2.8s	2.8s	2.4s

9. CHARACTERISTICS

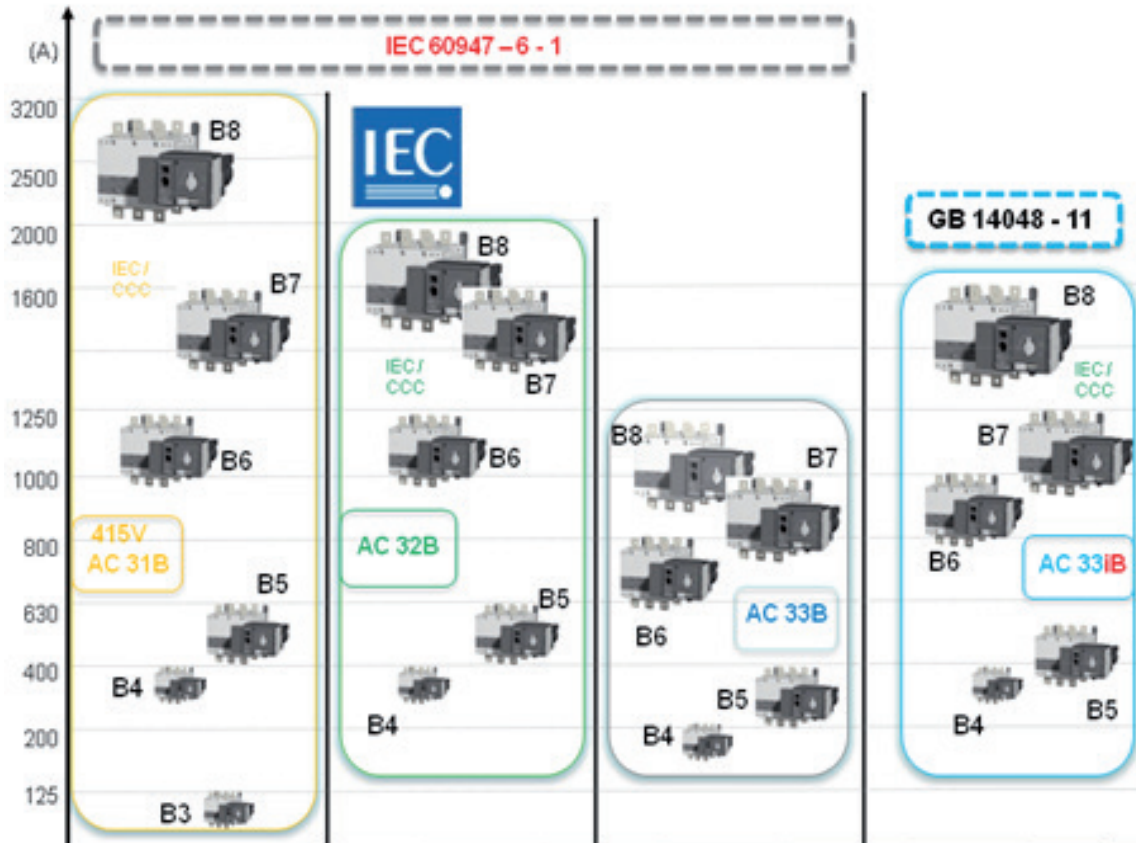

Characteristics according to IEC 60947-3 and IEC 60947-6-1

125 to 630 A

Thermal current I_{th} to 40°C	125 A	160 A	200 A	250 A	315 A	400 A	500 A	630 A
Frame size	B3	B3	B3	B4	B4	B4	B5	B5
Rated insulation voltage U_i (V) (power circuit)	800	800	800	1000	1000	1000	1000	1000
Rated impulse withstand voltage U_{imp} (kV) (power circuit)	8	8	8	12	12	12	12	12
Rated insulation voltage U_i (V) (control circuit)	300	300	300	300	300	300	300	300
Rated impulse withstand voltage U_{imp} (kV) (control circuit)	4	4	4	4	4	4	4	4

Rated operational currents I_e (A) according to IEC 60947-3

Rated voltage	Utilisation category	A/B ⁽¹⁾	A/B ⁽¹⁾	A/B ⁽¹⁾	A/B ⁽¹⁾	A/B ⁽¹⁾	A/B ⁽¹⁾	A/B ⁽¹⁾	A/B ⁽¹⁾
415 VAC	AC-21 A / AC-21 B	125/125	160/160	200/200	250/250	315/315	400/400	500/500	630/630
415 VAC	AC-22 A / AC-22 B	125/125	160/160	200/200	250/250	315/315	400/400	500/500	630/630
415 VAC	AC-23 A / AC-23 B	125/125	160/160	200/200	200/200	315/315	400/400	500/500	500/630
500 VAC	AC-21 A / AC-21 B	125/125	160/160	200/200	250/250	315/315	400/400	500/500	630/630
500 VAC	AC-22 A / AC-22 B	125/125	160/160	200/200	200/250	200/315	200/400	500/500	500/500
500 VAC	AC-23 A / AC-23 B	80/80	80/80	80/80	200/200	200/200	200/200	400/400	400/400
690 VAC ⁽³⁾	AC-21 A / AC-21 B	125/125	160/160	200/200	200/200	200/200	200/200	500/500	500/500
690 VAC ⁽³⁾	AC-22 A / AC-22 B	125/125	125/125	125/125	160/160	160/160	160/160	400/400	400/400
690 VAC ⁽³⁾	AC-23 A / AC-23 B	63/80	63/80	63/80	125/125	125/125	125/125	400/400	400/400
220 VDC	DC-21 A / DC-21 B	125/125	160/160	200/200	250/250	250/250	250/250	500/500	630/630
220 VDC	DC-22 A / DC-22 B	125/125	160/160	200/200	250/250	250/250	250/250	500/500	630/630
220 VDC	DC-23 A / DC-23 B	125/125	125/125	125/125	200/200	200/200	200/200	500/500	630/630
440 VDC ⁽²⁾	DC-21 A / DC-21 B	125/125	125/125	125/125	200/200	200/200	200/200	500/500	630/630
440 VDC ⁽²⁾	DC-22 A / DC-22 B	125/125	125/125	125/125	200/200	200/200	200/200	500/500	630/630
440 VDC ⁽²⁾	DC-23 A / DC-23 B	125/125	125/125	125/125	200/200	200/200	200/200	500/500	630/630

Rated operational currents I_e (A) according to IEC 60947-6-1

Rated voltage	Utilisation category								
415 VAC	AC-31 B	125	160	200	250	315	400	500	630
415 VAC	AC-32 B				200	315	400	500	500
415 VAC	AC-33 B				200	200	200	400	400

Current rated as conditional short-circuit with fuse gG DIN, according to IEC 60947-3

Prospective fuse protected short-circuit withstand at 415 VAC(6)	100	100	50	50	50	50	50	50	50
Prospective fuse protected short-circuit withstand at 690 VAC(kA rms)				50	50	50	50	50	50
Associated fuse rating (A)	125	160	200	250	315	400	500	630	630

Short-circuit withstand without protection as per IEC 60947-3

Rated short-time withstand current 0.3s I_{cw} at 415 VAC (kA rms)	12	12	12	15 ⁽⁴⁾	15 ⁽⁴⁾	15 ⁽⁴⁾	17 ⁽⁴⁾	17 ⁽⁴⁾	17 ⁽⁴⁾
Rated short-time withstand current 1s I_{cw} at 415 VAC (kA rms)	7	7	7	8 ⁽⁴⁾	8 ⁽⁴⁾	8 ⁽⁴⁾	11 ⁽⁴⁾	10 ⁽⁴⁾	10 ⁽⁴⁾
Rated peak withstand current at 415 VAC (kA peak)	20	20	20	30	30	30	45	45	45

Short-circuit withstand without protection as per IEC 60947-6-1

Rated short-time withstand current 30 ms I_{cw} at 415 VAC (kA rms)	10	10	10	10	10	10			
Rated short-time withstand current 60 ms I_{cw} at 415 VAC (kA rms)							10	12.6	

Connection

Minimum Cu cable cross-section as per IEC 60947-1 (mm ²)	35	35	50	95	120	185	2 x 95	2 x 120
Recommended Cu busbar cross-section (mm ²)							2 x 32 x 5	2 x 40 x 5
Maximum Cu cable cross-section (mm ²)	50	95	120	150	240	240	2 x 185	2 x 300
Maximum Cu busbar width (mm)	25	25	25	32	32	32	50	50
Min./max. tightening torque (Nm)	9/13	9/13	9/13	20/26	20/26	20/26	40/45	40/45

Switching time (rated voltage, after receiving command)

Transfer time I-II or II-I (s)	0.85	0.85	0.85	0.9	0.9	0.9	0.95	0.95
I-0 or II-0 (s)	0.55	0.55	0.55	0.5	0.5	0.5	0.55	0.55
Contact transfer time ("black-out" I-II) minimum (s)	0.3	0.3	0.3	0.4	0.4	0.4	0.4	0.4

Power supply

Min./max. power (VAC)	166/332	166/332	166/332	166/332	166/332	166/332	166/332	166/332
-----------------------	---------	---------	---------	---------	---------	---------	---------	---------

Control supply power demand

Demand/rated power (VA) - ATyS r, ATyS d	184/92	184/92	184/92	276/115	276/115	276/115	276/150	276/150
Demand/rated power (VA) - ATyS t, g, p	206/114	206/114	206/114	298/137	298/137	298/137	298/172	298/172

Mechanical specifications

Durability (number of operating cycles)	10,000	10,000	10,000	8,000	8,000	8,000	5,000	5,000
Weight ATyS r 3 P / 4 P (kg)	5.7/ 6.9	5.7/ 6.9	5.7/ 6.9	6.6/ 7.4	6.7/ 7.8	6.7/ 7.8	11.4/ 13.3	11.9/ 14.0
Weight ATyS d 3 P / 4 P (kg)	6.3/ 7.5	6.3/ 7.5	6.3/ 7.5	7.2/ 8.0	7.3/ 8.4	7.3/ 8.4	12.0/ 13.9	12.5/ 14.6
Weight ATyS t, g, p 3 P / 4 P (kg)	6.8/ 8.0	6.8/ 8.0	6.8/ 8.0	7.7/ 8.5	7.8/ 8.9	7.8/ 8.9	12.5/ 14.4	13.0/ 15.1

(1) Category with index A = frequent operation - Category with index B = infrequent operation.

(2) 3-pole device with 2 pole in series for the "+" and 1 pole for the "-".

4-pole device with 2 poles in series by polarity.

(3) Interphase barriers must be installed on the products.

(4) Values given at 690 VAC.

800 to 3200 A

Thermal current I_{th} at 40°C	800 A	1000 A	1250 A	1600 A	2000 A	2500 A	3200 A
Frame size	B6	B6	B6	B7	B8	B8	B8
Rated insulation voltage U_i (V) (power circuit)	1000	1000	1000	1000	1000	1000	1000
Rated impulse withstand voltage U_{imp} (kV) (power circuit)	12	12	12	12	12	12	12
Rated insulation voltage U_i (V) (control circuit)	300	300	300	300	300	300	300
Rated impulse withstand voltage U_{imp} (kV) (control circuit)	4	4	4	4	4	4	4

Rated operational currents I_e (A) according to IEC 60947-3

Rated voltage	Utilisation category	A/B ⁽¹⁾	A/B ⁽¹⁾	A/B ⁽¹⁾	A/B ⁽¹⁾	A/B ⁽¹⁾	A/B ⁽¹⁾	A/B ⁽¹⁾
415 VAC	AC-21 A / AC-21 B	800/800	1000/1000	1250/1250	1600/1600	-/2000	-/2500	-/3200
415 VAC	AC-22 A / AC-22 B	800/800	1000/1000	1250/1250	1600/1600	-/2000	-/2500	-/3200
415 VAC	AC-23 A / AC-23 B	800/800	1000/1000	1250/1250	1250/1250	-/1600	-/1600	-/1600
500 VAC	AC-21 A / AC-21 B	800/800	1000/1000	1250/1250	1600/1600	-/2000	-/2000	-/2000
500 VAC	AC-22 A / AC-22 B	630/630	800/800	1000/1000	1600/1600			
500 VAC	AC-23 A / AC-23 B	630/630	630/630	800/800	1000/1000			
690 VAC ⁽³⁾	AC-21 A / AC-21 B	800/800	1000/1000	1250/1250	1600/1600	-/2000	-/2000	-/2000
690 VAC ⁽³⁾	AC-22 A / AC-22 B	630/630	800/800	1000/1000	1000/1000			
690 VAC ⁽³⁾	AC-23 A / AC-23 B	630/630	630/630	800/800	800/800			
220 VDC	DC-21 A / DC-21 B	800/800	1000/1000	1250/1250	1250/1250			
220 VDC	DC-22 A / DC-22 B	800/800	1000/1000	1250/1250	1250/1250			
220 VDC	DC-23 A / DC-23 B	800/800	1000/1000	1250/1250	1250/1250			
440 VDC ⁽²⁾	DC-21 A / DC-21 B	800/800	1000/1000	1250/1250	1250/1250			
440 VDC ⁽²⁾	DC-22 A / DC-22 B	800/800	1000/1000	1250/1250	1250/1250			
440 VDC ⁽²⁾	DC-23 A / DC-23 B	800/800	1000/1000	1250/1250	1250/1250			

Rated operational currents I_e (A) according to IEC 60947-6-1

Rated voltage	Utilisation category							
415 VAC	AC-31 B	800	1000	1250	1600	2000	2500	3200
415 VAC	AC-32 B	800	1000	1250	1250	2000	2000	2000
415 VAC	AC-33 B	800	1000	1000	1000	1250	1250	1250

Current rated as conditional short-circuit with fuse gG DIN, according to IEC 60947-3

Prospective fuse protected short-circuit withstand at 415 VAC (kA rms)	50	50	100	100				
Prospective fuse protected short-circuit withstand at 690 VAC (kA rms)	50	50	50					
Associated fuse rating (A)	800	1000	1250	2x800				

Short-circuit withstand without protection as per IEC 60947-3

Rated short-time withstand current 0.3s I_{cw} at 415 VAC (kA rms)	64	64	64	78	78	78	78	78
Rated short-time withstand current 1s I_{cw} at 415 VAC (kA rms)	35	35	35	50	50	50	50	50
Rated peak withstand current at 415 VAC (kA peak)	55	55	80	110	120	120	120	120

Short-circuit withstand without protection as per IEC 60947-6-1

Rated short-time withstand current 30 ms I_{cw} at 415 VAC (kA rms)								
Rated short-time withstand current 60 ms I_{cw} at 415 VAC (kA rms)	20	20	25	32	50	50	50	50

Connection

Minimum Cu cable cross-section as per IEC 60947-1 (mm ²)	2 x 185							
Recommended Cu busbar cross-section (mm ²)	2 x 50 x 5	2 x 63 x 5	2 x 60 x 7	2 x 100 x 5	3 x 100 x 5	2 x 100 x 10	3 x 100 x 10	
Maximum Cu cable cross-section (mm ²)	4 x 185	4 x 185	4 x 185	6 x 185				
Maximum Cu busbar width (mm)	63	63	63	100	100	100	100	
Min./max. tightening torque (Nm)	9/13	9/13	20/26	40/45	40/45	40/45	40/45	

Switching time (rated voltage, after receiving command)

Transfer time I-II or II-I (s)	2.8	2.8	2.8	2.9	2.8	2.8	2.8	
I-O or II-O (s)	1.4	1.4	1.4	1.4	1.8	1.8	1.8	
Contact transfer time ("black-out" I-II) minimum (s)	1.4	1.4	1.4	1.5	1	1	1	

Power supply

Min./max. power (VAC)	166/332	166/332	166/332	166/332	166/332	166/332	166/332	
-----------------------	---------	---------	---------	---------	---------	---------	---------	--

Control supply power demand

Demand/rated power (VA) - ATyS r, ATyS d	460/184	460/184	460/184	460/230	812/322	812/322	812/322	
Demand/rated power (VA) - ATyS t, g, p	482/206	482/206	482/206	482/252	834/344	834/344	834/344	

Mechanical specifications

Durability (number of operating cycles)	4,000	4,000	4,000	3,000	3,000	3,000	3,000	
Weight ATyS r 3 P / 4 P (kg)	27.9/ 32.2	28.4/ 32.9	28.9/ 33.6	33.1/ 39.4	50.7/ 61.6	50.7/ 61.6	61.0/ 75.3	
Weight ATyS d 3 P / 4 P (kg)	28.5/ 32.8	29.0/ 33.5	29.5/ 34.2	33.7/ 40.0	51.3/ 62.2	51.3/ 62.2	61.6/ 75.9	
Weight ATyS t, g, p 3 P / 4 P (kg)	29.0/ 33.3	29.5/ 34.0	30.0/ 34.7	34.2/ 40.5	51.8/ 62.7	51.8/ 62.7	62.1/ 76.4	

(1) Category with index A = frequent operation - Category with index B = infrequent operation.

(2) 3-pole device with 2 pole in series for the "+" and 1 pole for the "-".

4-pole device with 2 poles in series by polarity.

(3) Interphase barriers must be installed on the products.

(4) Values given at 690 VAC.

10. PREVENTIVE MAINTENANCE

It is recommended to verify the tightening torque of all connections and to operate the product in a full operating cycle (I – 0 – II – 0 – I: Auto and Manual) at least once a year.

Note: Maintenance should be planned carefully and carried out by qualified and authorised personnel. Consideration of the critical level and application where the product is installed should form an essential and integral part of the maintenance plan. Good engineering practice is imperative whilst all necessary precautions must be taken to ensure that the intervention (whether directly or indirectly) remains safe in all aspects.

11. TROUBLE SHOOTING GUIDE

The ATyS r does not operate electrically	<ul style="list-style-type: none"> • Verify the power supply on terminals 301-302: 208 - 277 VAC \pm20 % • Verify that the front selector switch is in position (AUT) • Verify that contacts 313 and 317 are open. • Verify that the power LED (Green) is On whilst the fault LED (RED) is off. • Verify that the product is available with contacts 63A and 64A closed.
It is not possible to manually operate the switch	<ul style="list-style-type: none"> • Verify that the front selector switch position is on the Manual position. • Make sure that the product is not padlocked • Verify the rotation direction of the handle • Apply a sufficient progressive action in the direction as indicated on the handle
Electrical operation does not correspond to external order I,O,II	<ul style="list-style-type: none"> • Verify the selected control logic wiring (impulse or contactor) • Verify the connector connections.
The fault/manual LED is ON	<ul style="list-style-type: none"> • The FAULT / MANUAL LED is on when in manual mode (this is normal) and in AUT Mode when there is an internal fault in the ATyS r. To reset a fault condition switch the ATyS r from AUT to Manu and back to AUT. Should the fault LED remain on you will need to localize and clear the fault prior to reset. • The FAULT / Manual LED will also be on when contact 313 is closed with 317. (Force the ATyS r to off position). This is a normal condition. • Should the Fault LED remain on abnormally, contact SOCOMEC.
Impossible to padlock	<ul style="list-style-type: none"> • Verify that the front selector switch is in manual position • Verify that the emergency handle for manual operation is not inserted into the ATyS r manual slot. • Verify that the ATyS r is in 0 position (Padlocking is only possible in 0 position for standard products)

12. ACCESSORIES

12.1. Terminal shrouds

Use

IP2X protection against direct contact with terminals or connecting parts.

Advantages

Perforations allow remote thermographic inspection without the need to remove the shrouds.

Rating (A)	Frame size	No. of poles	Position	Reference
125 ... 200	B3	3 P	top / bottom / front (I) / rear (II)	2694 3014 ⁽¹⁾⁽²⁾
125 ... 200	B3	4 P	top / bottom / front (I) / rear (II)	2694 4014 ⁽¹⁾⁽²⁾
250 ... 400	B4	3 P	top / bottom / front (I) / rear (II)	2694 3021 ⁽¹⁾⁽²⁾
250 ... 400	B4	4 P	top / bottom / front (I) / rear (II)	2694 4021 ⁽¹⁾⁽²⁾
500 ... 630	B5	3 P	top / bottom / front (I) / rear (II)	2694 3051 ⁽¹⁾⁽²⁾
500 ... 630	B5	4 P	top / bottom / front (I) / rear (II)	2694 4051 ⁽¹⁾⁽²⁾

(1) To shroud front switch top and bottom 2 references required.

(2) To fully shroud front, rear, top and bottom 4 references required.

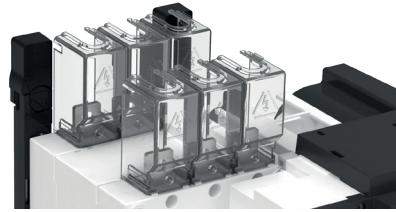

12.2. Terminal screens

Use

Top and bottom protection against direct contact with terminals or connection parts.

For upstream and downstream protection, order the reference once.

Rating (A)	Frame size	No. of poles	Position	Reference
125 ... 200	B3	3 P	top / bottom	1509 3012
125 ... 200	B3	4 P	top / bottom	1509 4012
250 ... 400	B4	3 P	top / bottom	1509 3025
250 ... 400	B4	4 P	top / bottom	1509 4025
500 ... 630	B5	3 P	top / bottom	1509 3063
500 ... 630	B5	4 P	top / bottom	1509 4063
800 ... 1250	B6	3 P	top / bottom	1509 3080
800 ... 1250	B6	4 P	top / bottom	1509 4080
1600	B7	3 P	top / bottom	1509 3160
1600	B7	4 P	top / bottom	1509 4160
2000 ... 3200	B8	3 P	top / bottom	1509 3200
2000 ... 3200	B8	4 P	top / bottom	1509 4200

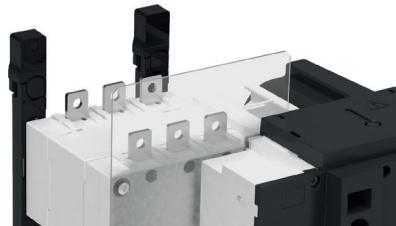

12.3. Bridging bars

Use

For bridging power terminals on the top or bottom side of the switch. One piece required per pole.

Rating (A)	Frame size	No. of poles	Section (mm)	Reference
125 ... 200	B3	3 P	20 x 2.5	4109 3019
125 ... 200	B3	4 P	20 x 2.5	4109 4019
250	B4	3 P	25 x 2.5	4109 3025
250	B4	4 P	25 x 2.5	4109 4025
315 ... 400	B4	3 P	32 x 5	4109 3039
315 ... 400	B4	4 P	32 x 5	4109 4039
500	B5	3 P	32 x 5	4109 3050
500	B5	4 P	32 x 5	4109 4050
630	B5	3 P	50 x 5	4109 3063
630	B5	4 P	50 x 5	4109 4063
800 ... 1000	B6	3 P	50 x 6	4109 3080
800 ... 1000	B6	4 P	50 x 6	4109 4080
1250	B6	3 P	60 x 8	4109 3120
1250	B6	4 P	60 x 8	4109 4120
1600	B7	3 P	90 x 10	4109 3160
1600	B7	4 P	90 x 10	4109 4160

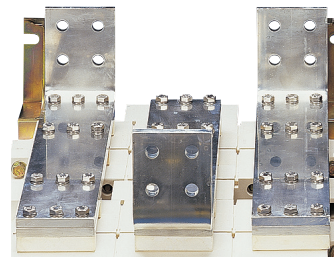
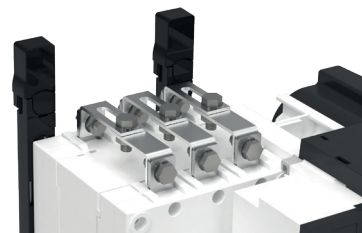

12.4. Copper bar connection kits

Use

Enables:

- connection between the two power terminals of the same pole for 2000 to 3200 A ratings (Fig. 1 and Fig. 2)
 - top or bottom bridging connection (Fig. 3).
- For 3200 A rating, the connection pieces (part A) are delivered bridged from factory.

Bolt sets must be ordered separately. The user manual for these specific accessories can be downloaded from www.socomec.com.

Fig. 1

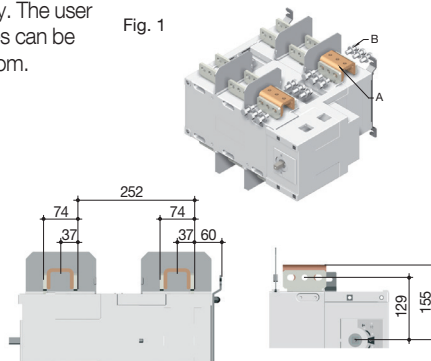

Fig. 2

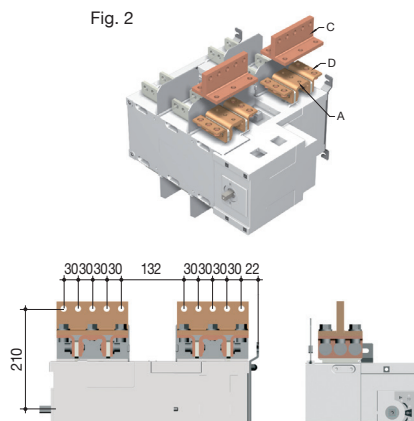
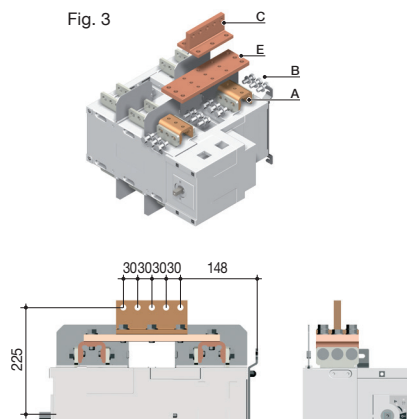

Fig. 3



Top or bottom flat connection - Fig. 1

Rating (A)	Frame size	Piece	Quantity to order per pole ⁽¹⁾	Reference
2000 ... 2500	B8	Connection - part A	2	2619 1200
2000 ... 2500	B8	Bolt set - part B	2	2699 1200
3200	B8	Connection - part A		included
3200	B8	Bolt set - part B	2	2699 1200

Top or bottom edgewise connection - Fig. 2

Rating (A)	Frame size	Piece	Quantity to order per pole ⁽¹⁾	Reference
2000 ... 2500	B8	Connection - part A	2	2619 1200
2000 ... 2500	B8	T piece - part C	2	2629 1200(2)
2000 ... 2500	B8	Bracket - part D	2	2639 1200(2)
3200	B8	Connection - part A		included
3200	B8	T piece - part C	2	2629 1200(2)
3200	B8	Bracket - part D	2	2639 1200(2)

Top or bottom bridging connection - Fig. 3

Rating (A)	Frame size	Piece	Quantity to order per pole ⁽¹⁾	Reference
2000 ... 2500	B8	Connection - part A	2	2619 1200
2000 ... 2500	B8	Bolt set - part B	2	2699 1200
2000 ... 2500	B8	Bar - part E	1	4109 0320(2)
2000 ... 2500	B8	T piece - part C	1	2629 1200(2)
3200	B8	Connection - part A		included
3200	B8	Bolt set - part B	2	2699 1200
3200	B8	Bar - part E	1	4109 0320(2)
3200	B8	T piece - part C	1	2629 1200(2)

(1) Example for 3 pole device equipped upstream only: Order 3 times the indicated quantities.
 (2) Bolt set is provided with the accessories.

12.5. Solid neutral

Use

The connection kit enables the connection between the input and output neutrals, without any need to switch the neutral.

Rating (A)	Frame size	Reference
125 ... 200	B3	9509 0012
200 ... 315	B4	9509 0025
400	B4	9509 0040
500 ... 630	B5	9509 0063
800 ... 1000	B6	9509 0080
1250	B6	9509 0120
1600	B7	9509 0160

12.6. Autotransformer 400/230 VAC

Use

For applications without neutral, this autotransformer provides the 230 VAC required to power these ATyS products.

Rating (A)	Frame size	Reference
125 ... 3200	B3 ... B8	1599 4064

12.7. DC power supply

Use

Allows an ATyS to be supplied from a 12 or 24 VDC source.
To be positioned as close as possible to the DC power supply source.

Rating (A)	Frame size	Operating voltage	Reference
125 ... 3200	B3 ... B8	12 VDC / 230 VAC	1599 5012
125 ... 3200	B3 ... B8	24 VDC / 230 VAC	1599 5112

12.8. Voltage relay

Use

The ATyS DS is a voltage relay for monitoring a three-phase power supply source. The fault relay will close as soon as a fault is detected on the supply being monitored.

Rating (A)	Reference
DS	192X 0056



12.9. Door protective surround

Use

When direct access to the ATyS front face (mode selection, manual operation, display...) is required, the door surround can be utilised to provide a clean and safe finish to the panel's cut-out.

For ATyS r		
Rating (A)	Frame size	Reference
125 ... 630	B3 ... B5	1529 0012
800 ... 3200	B6 ... B8	1529 0080

For ATyS d, t, g and p		
Rating (A)	Frame size	Reference
125 ... 630	B3 ... B5	1539 0012
800 ... 3200	B6 ... B8	1539 0080

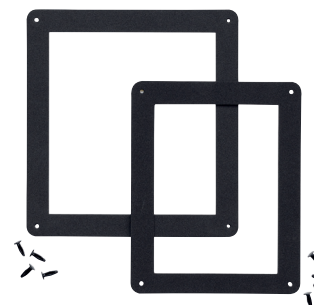

aty_s_5915_a_2_cat

12.10. Auxiliary contacts (additional)

Use

Pre breaking and signalling of positions I and II: each reference provides a single factory or customer fitted NO/NC contacts for both positions. Low level auxiliary contacts: please consult us.

Rating (A)	Frame size	Nominal current (A)	Operating current I _o (A)			
			250 VAC AC-13	400 VAC AC-13	24 VDC DC-13	48 VDC DC-13
125 ... 3200	B3 ... B8	16	12	8	14	6

Rating (A)	Frame size	Type of mounting	Reference
125 ... 630	B3 ... B5	Customer fitted	1599 0502 ⁽¹⁾
125 ... 630	B3 ... B5	Factory fitted	1599 0002 ⁽¹⁾
800 ... 1600	B6 ... B7	Customer fitted	1599 0532 ⁽¹⁾
800 ... 1600	B6 ... B7	Factory fitted	1599 0032 ⁽¹⁾
2000 ... 3200	B8	-	included

(1) Up to 2 auxiliary contacts can be ordered.

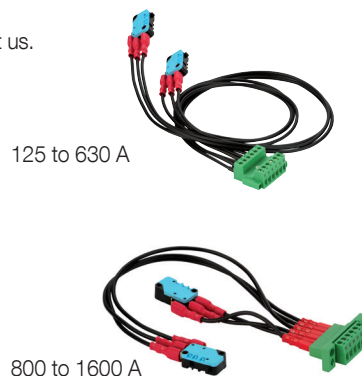

12.11. 3 position padlocking (I - 0 - II)

Use

Enables the ATyS to be padlocked in the 3 positions 0, I and II (factory fitted).

Rating (A)	Frame size	Reference
125 ... 630	B3 ... B5	9599 0003
800 ... 3200	B6 ... B8	9599 0004



12.12. RONIS Key interlocking system

Use

With the product in manual mode, it enables locking in position 0 using a RONIS EL11AP lock (factory fitted).

As standard, locking in position 0.

Optional padlocking in 3 positions: locking in position I, 0 or II.



Rating (A)	Frame size	Reference
125 ... 630	B3 ... B5	9599 1006
800 ... 3200	B6 ... B8	9599 1004

12.13. ATS Controllers ATyS C25/C55/C65

Use

ATyS C25/C55/C65 are ATS controllers. They ensure the automatic control of remotely controlled transfer switches, ATyS, ATyS S and ATyS M, as well as contactors, circuit breakers or other motorised switches.



Type	ATyS C25 Reference	ATyS C55 Reference	ATyS C65 Reference
Supplied from measurement circuit or from optional DC aux. supply	1600 0025	1600 0055	1600 0065

12.14. Auto/Manual key selector

Use

Replaces the standard Auto/Manual selector knob with a key selector, providing added security by preventing unauthorised use of product. Customer assembly required.



aty_s_869_a

Rating (A)	Frame size	Reference
125 ... 3200	B3 ... B8	9599 1007

12.15. Double power supply - DPS

Use

Allows an ATyS r to be supplied by two 230 VAC, 50/60 Hz networks.

Input

- The input is considered "active" from 200 VAC.
- Maximum voltage: 288 VAC.
- Internal protection: each input is fuse protected 3.15 A.
- Connection on terminals: max. 6 mm².
- Modular device: 4 module width.

Description of accessories	Reference
DPS	1599 4001

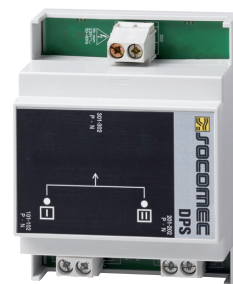
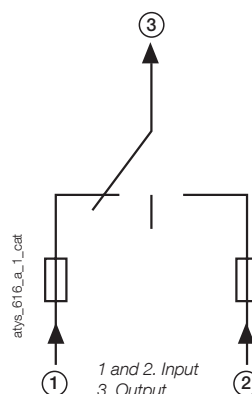

13. SPARE PARTS

13.1. Motorisation module

The motorisation module of ATyS r, d, t, g and p can be easily replaced in case of problems, even when the load is supplied. Provided with required connectors.

Rating	References
125 ... 200 A	9509 5020
250 ... 400 A	9509 5040
500 ... 630 A	9509 5063
800 ... 1250 A	9509 5120
1600 A	9509 5160
2000 ... 3200 A	9509 5320



13.2. Power section

References to be used for replacing the switching module of ATyS r, d, t, g or p. Please contact SOCOMEC.

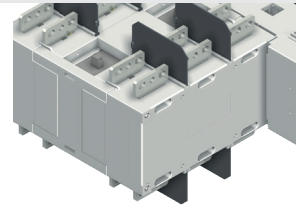

13.3. Kit of connectors

The kit contains all connectors need to be replaced or missing for ATyS r, d, t, g or p.

Connectors Kit for	Reference
ATyS r, d, t, g, p	1609 0597

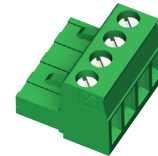

13.4. Metal mounting brackets

This accessory may also be used to replace the original metal mounting brackets. Composed of 2 metal mounting brackets and 4 plastic covers.

Rating (A)	Frame size	Reference
125 ... 630	B3 ... B5	1509 0003



14. ATYS FAMILY: ORDERING INFORMATION

The following is an ordering guide for ATYS Motorised Transfer Switches delivered inclusive of the emergency handle and storage clip. This guide is intended so as to explain the logic behind SOCOMEC ATYS reference numbers.

When ordering please consult the latest SOCOMEC catalogue.

Typical UL 1008 (Optional Standby Power) ATYS reference



97 2 3 4 0 1 0

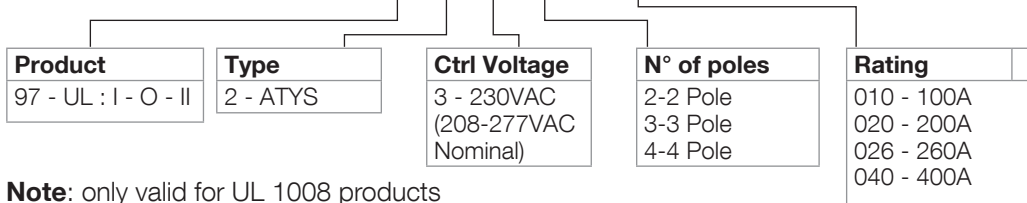

Note: only valid for UL 1008 products

Typical IEC 60947-6-1 ATYS reference



95 2 3 4 063

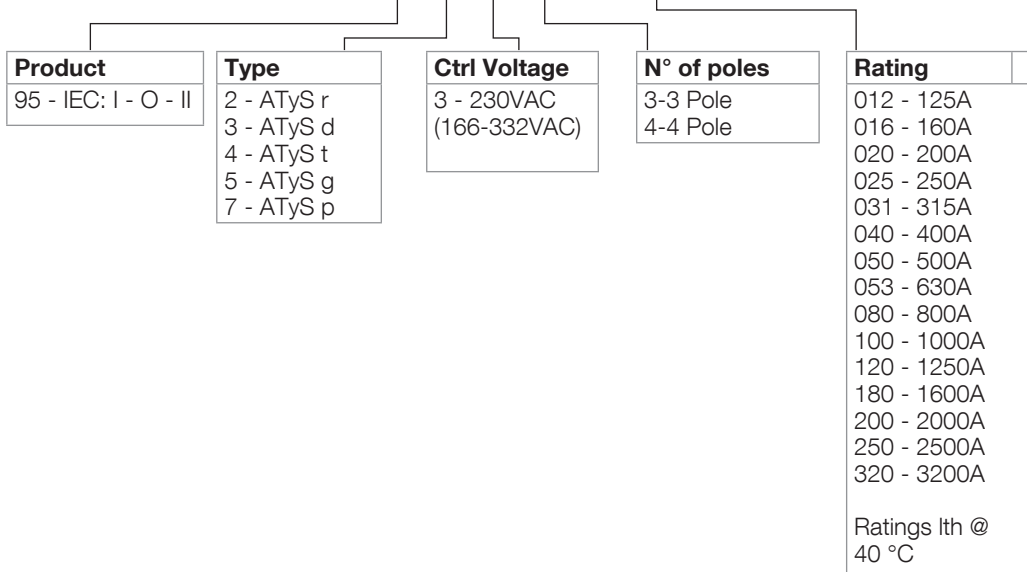

CORPORATE HQ CONTACT:
SOCOMECSAS
1-4 RUE DE WESTHOUSE
67235 BENFELD, FRANCE

www.socomec.com

