





01 Pushbutton Heads	page 317	05 Toggle Heads	page 322
02 Emergency Stop Buttons	page 318	06 Key Actuators	page 323
03 Knob Set for Rotary Switch / Potentiometer	page 321	07 Pilot Lights	page 326
04 Selector Heads	page 321		



IP65 degree of protection

 illuminating option

6mm operating travel

 labelling option



Mounting Depth Dimensions

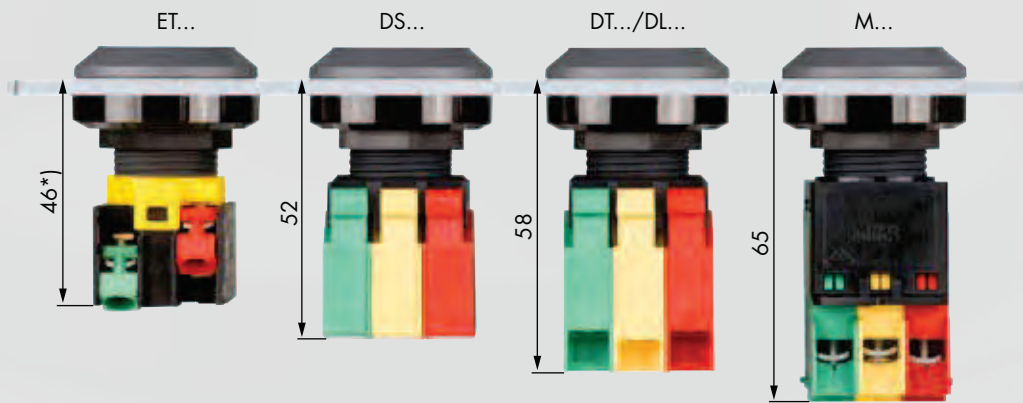

* ETR2 66mm, ETLR 55mm, ETLR2 75mm, EL9R 41mm



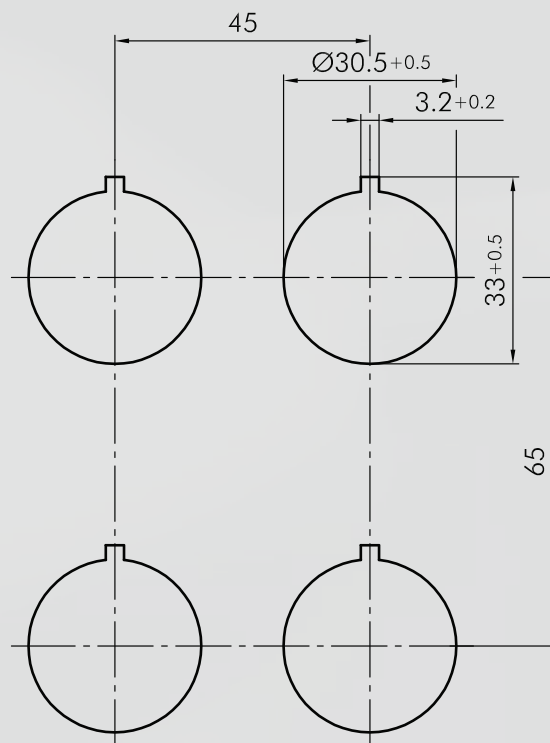

Cutout Dimensions

Mounting grid acc. to DIN EN 50007

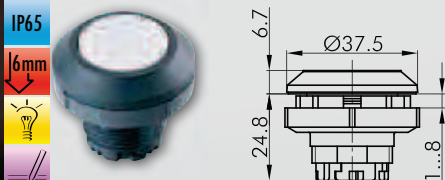

Pushbutton Heads (momentary/push-push)

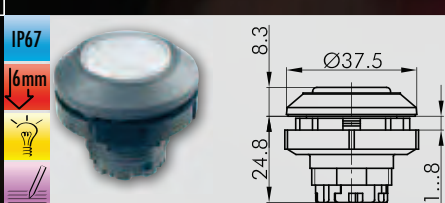
Lenses and nameplates to be ordered separately

Illustration	Dimensions	Description	Type
		Pushbutton Head front bezel charcoal	KRT
		Flat Lens, transparent available in blue-BL, yellow-GB, green-GN, clear-KL, red-RT, opalwhite-WS, add code letter to type number, e.g. TG22BL	TG22...
		Nameplate with standard imprint, please specify index number (see nameplates)	BSK...
		Nameplate with special imprint according to customer's specifications	BSKB
		Blank Nameplate	BSKU
		Membrane Pushbutton Head with fully closed, transparent silicone cap, down to -50° C front bezel charcoal	KRTM
		Flat Lens, transparent available in blue-BL, yellow-GB, green-GN, clear-KL, red-RT, opalwhite-WS, add code letter to type number, e.g. T20FBL	T20F...
		Nameplate with standard imprint, please specify index number (see nameplates)	BSRX...

Emergency Stop Buttons

Illustration	Dimensions	Description	Type
--------------	------------	-------------	------

		Nameplate with special imprint according to customer's specifications	BSRXB
--	--	---	--------------



		Blank Nameplate	BSRXU
--	--	------------------------	--------------

IP67

		Sealing Cap made of silicone rubber, down to -50°C	TK40
--	--	--	-------------

IP65

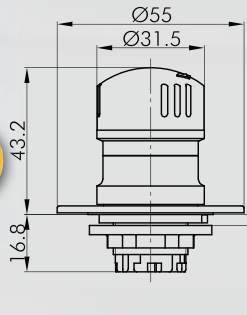

		Emergency-stop Head consisting of QRUV and adapter	
		foolproof	Yes
		switching position indicator	Yes
		anti-lock collar	No
		release	twist right or left
		mushroom head	red
		front bezel	yellow

KRUV

IP65

IP66

IP69K

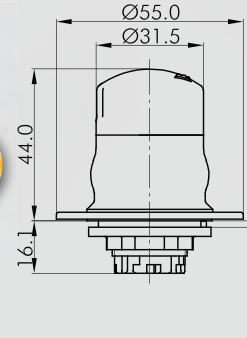

		Emergency-stop Head for hygienic applications consisting of QRUV and adapter, conforms to BG acc. to DIN EN 1672-2 and GS-FW01/01	
		foolproof	Yes
		switching position indicator	No
		anti-lock collar	No
		release	twist right or left
		mushroom head	red
		front bezel	yellow

KRUV

IP65

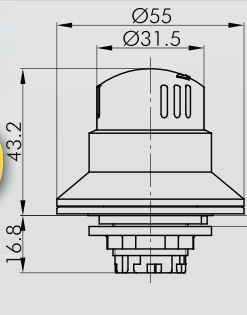

		Emergency-stop Head consisting of QRBUV and adapter	
		foolproof	Yes
		switching position indicator	Yes
		anti-lock collar	Yes
		release	twist right or left
		mushroom head	red
		front bezel	yellow

KRBUV

Emergency Stop Buttons Mushroom Heads

Illustration

Dimensions

Description

Type

IP65



Emergency-stop Head

consisting of QRBUVSE and adapter

foolproof	Yes
switching position indicator	Yes
anti-lock collar	Yes
release	key release
mushroom head	red
front bezel	yellow

KRBUVSE

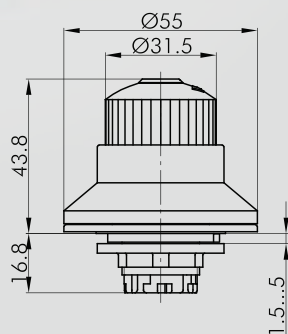

For further emergency stops, please refer to the heading „Emergency-stop Heads“

The emergency-stop heads can also be supplied in other colours and as latching mushroom heads.

IP65



Latching Mushroom Head

with pressure point to avoid accidental actuation

foolproof	No
switching position indicator	No
anti-lock collar	No
release	twist
Standard	DIN EN 60204/VDE 0113
front bezel	charcoal

KRV

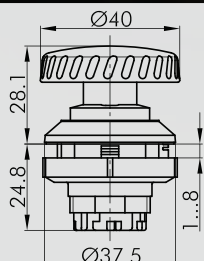

KOMBITAST-R

Ø 30 mm

Mushroom Heads

Illustration

Dimensions

Description

Type

IP65

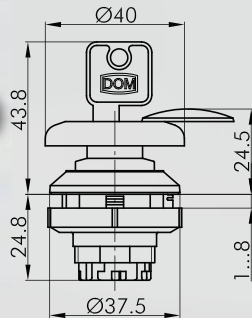

Latching Mushroom Head

with keyhole cover

foolproof

No

switching position indicator

No

anti-lock collar

No

release

key release

Standard

DIN EN 60204/VDE 0113

front bezel

charcoal

KRVSCH

IP65

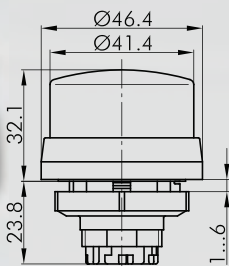

Mushroom Head, momentary

with yellow anti-lock collar,

other mushroom head colours on request

switching position indicator

No

anti-lock collar

Yes

mushroom head

red

front bezel

yellow

KRGS

**Knob Set for potentiometers
Selector Heads (momentary/maintained)**

⊏ = Switching position
> = Spring return

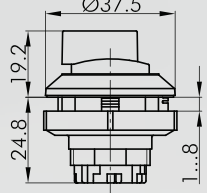

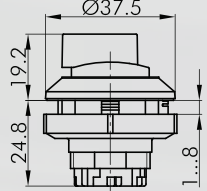

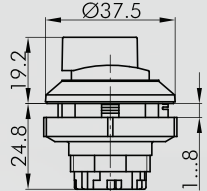

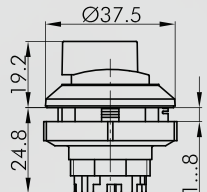

Illustration	Dimensions	Description	Type
<p>IP65</p>	<p>Knob Set for potentiometers for potentiometers of 6 mm shaft dia. and thread M10x0.75. Delivery without potentiometer. Shaft length: approx. 50 mm ± 2 mm incl. fastening thread</p>	<p>front bezel charcoal</p>	<p>KRR</p>
<p>IP65</p>	<p>Selector Head front bezel charcoal</p>	<p>90°</p>	<p>KRWA</p>
<p>IP65</p>	<p>Selector Head front bezel charcoal</p>	<p>45° 45°</p>	<p>KRWB</p>
<p>IP65</p>	<p>Selector Head front bezel charcoal</p>	<p>45° 45°</p>	<p>KRWC</p>
<p>IP65</p>	<p>Selector Head, momentary front bezel charcoal</p>	<p>45°</p>	<p>KRSTA</p>

KOMBITAST-R

Ø 30 mm





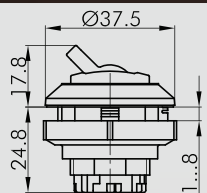

**Selector Heads (momentary/maintained)
Toggle Heads**

I = Switching position
> = Spring return

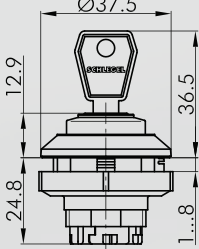
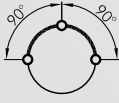
Illustration	Dimensions	Description	Type
<p>IP65</p> 		<p>Selector Head, momentary front bezel charcoal</p>	 <p>KRSTB</p>
<p>IP65</p> 		<p>Illuminated Selector Head inclusive four small, transparent colour plates in red, yellow, green and blue front bezel charcoal</p>	 <p>KRWAL</p>
<p>IP65</p> 		<p>Illuminated Selector Head inclusive four small, transparent colour plates in red, yellow, green and blue front bezel charcoal</p>	 <p>KRWBL</p>
<p>IP65</p> 		<p>Illuminated Selector Head inclusive four small, transparent colour plates in red, yellow, green and blue front bezel charcoal</p>	 <p>KRWCL</p>
<p>IP65</p> 		<p>Toggle Head red toggle (other colours on request) front bezel charcoal</p>	<p>KRK</p>

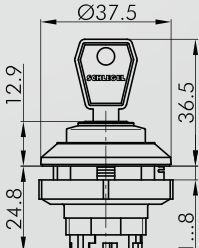
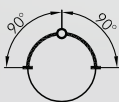
Key Actuators (momentary/maintained)

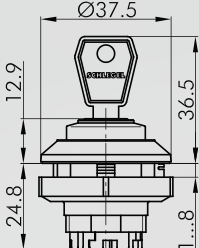
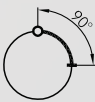
- I = Switching position
- > = Spring return
- = Key removable position

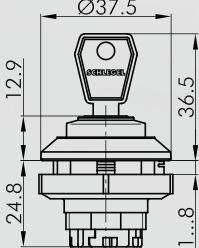
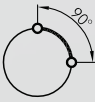
Illustration	Dimensions	Description	Type
		<p>Key Actuator including two keys other lock types on request front bezel charcoal</p>	 <p>KRSSA12E</p>
		<p>Key Actuator including two keys other lock types on request front bezel charcoal</p>	 <p>KRSSA13E</p>
		<p>Key Actuator including two keys other lock types on request front bezel charcoal</p>	 <p>KRSSA14E</p>
		<p>Key Actuator including two keys other lock types on request front bezel charcoal</p>	 <p>KRSSA15E</p>







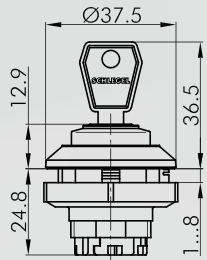

Control Units
 Actuators
 Bus Technology
 Locks
 Lock Solutions
 Padlocks
 Special Keys

KOMBITAST-R

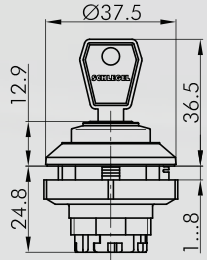
Ø 30 mm

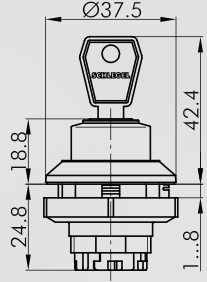

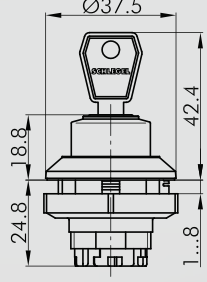

Key Actuators (momentary/maintained)

- I = Switching position
- > = Spring return
- = Key removable position

Illustration	Dimensions	Description	Type
		<p>Key Actuator including two keys other lock types on request front bezel charcoal</p>	 <p>KRSSA17E</p>
		<p>Key Actuator including two keys other lock types on request front bezel charcoal</p>	 <p>KRSSA18E</p>
		<p>Key Actuator including two keys other lock types on request front bezel charcoal</p>	 <p>KRSSA23E</p>
		<p>Key Actuator including two keys other lock types on request front bezel charcoal</p>	 <p>KRSSA24E</p>

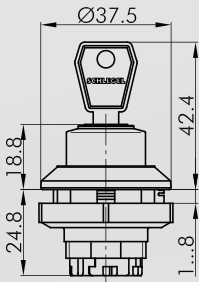
Key Actuators (momentary/maintained)
Accessories for Actuators

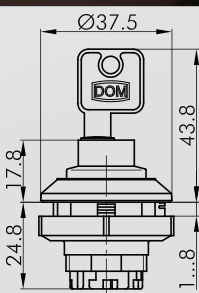
- I = Switching position
- > = Spring return
- = Key removable position

Illustration	Dimensions	Description	Type
		<p>Key Actuator including two keys other lock types on request front bezel charcoal</p>	 <p>KRSSA27E</p>
		<p>Lockable Pushbutton Head including two keys</p> <p>Type N: Depresses with or without key. Lock latches in depressed position and resets with key turned clockwise. Key removable in both positions.</p> <p>Type 1: Depresses only with key turned clockwise. Turn key into vertical position, the lock latches. Reset by turning key clockwise. Key removable in both vertical positions.</p> <p>Type 2: Depresses only with key in the right position (= basic position). Turn key into vertical position, the lock latches. Key only removable in the latching position. Reset by turning key clockwise.</p> <p>Type 3: Depresses only with key turned clockwise. The lock does NOT latch in depressed position (key neither turnable nor removable in depressed position; MOMENTARY). Key only removable in the off-position.</p>	<p>front bezel charcoal</p> <p>KRSSA...</p>
		<p>Spare Keys please specify key number</p>	<p>ES3A...</p>
		<p>Spare Keys please specify key number</p>	<p>ESE...</p>

Ø 30 mm

Pilot Light Heads/Pilot Lights

Lenses and nameplates to be ordered separately

Illustration

Dimensions

Description

Type

IP65

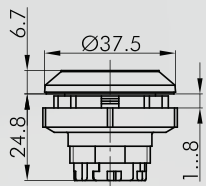

Pilot Light Head

front bezel

charcoal

KRN



High Lens, transparent, for pushbuttons and pilot lights KH23...

available in blue-BL, yellow-GB, green-GN, clear-KL, red-RT, opalwhite-WS, add code letter to type number, e.g. KH23BL



Domed Lens

KF23...

available in blue-BL, yellow-GB, green-GN, clear-KL, red-RT, opalwhite-WS, add code letter to type number, e.g. KF23BL



Nameplate

BSK...

with standard imprint, please specify index number (see nameplates)

Nameplate

BSKB







with special imprint according to customer's specifications

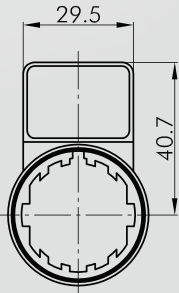

Blank Nameplate

BSKU

Accessories for Actuators

Illustration	Dimensions	Description	Type
		Mounting Tool with torque limitation for the series QUARTEX-R(-JUWEL), KOMBITAST-R, RONDEX, RONDEX-M, RVA, DUX-Basic	S22
		Mounting Tool Adapter with 1/4" connections for mounting tools S16 and S22	SRA
		External Nameplate Holder for outside marking of the actuators of the KOMBITAST-R series, accepts self-adhesive nameplates colour charcoal	KRABT
		Self-adhesive Nameplate, laser-printed Inscription according to customer's specifications Dimensions: 19 x 27 mm	BZ23G
		Self-adhesive Nameplate, blank Dimensions: 19 x 27 mm	BZ23U
		Self-adhesive Nameplate with standard inscription, please specify index no. (see nameplates) Dimensions: 19 x 27 mm	BZ23B...
		Yellow Nameplate self-adhesive PVC foil printing on request outer dia. 75 mm for mounting dia. 30 mm colour yellow	NAS_30

Accessories KOMBITAST-R

Ø 30 mm

Accessories for Actuators

Illustration

Dimensions

Description

Type



Yellow Nameplate with quadrilingual imprint

self-adhesive PVC foil
outer dia.75 mm
for mounting dia. 30 mm
colour yellow

NAS_30_548



Lamp Remover

for incandescent lamps FZR9...

LZ8



Universal Lens Remover

USK

IP65



Dummy

to close unused mounting apertures
colour charcoal

BVKR