

■ TRMS MULTIMETER

C.A 5273



ENGLISH

User's manual

PRECAUTIONS FOR USE

This instrument is compliant with the NF EN 61010-1 + NF EN 61010-2-030 safety standard for 1000 V voltages in category III or 600 V in category IV at an altitude below 2000 m, indoors, and with a maximum pollution level of 2.

Failure to comply with safety instructions can create a risk of electric shock, fire, explosion and destruction of the instrument or the installations.

- Do not use the instrument in an explosive atmosphere or in the presence of inflammable gas or smoke.
- Do not use the instrument on networks with a rated voltage or category higher than those mentioned.
- Respect the maximum rated voltages and currents between terminals and in relation to the earth.
- Do not use the instrument if it seems damaged, incomplete or incorrectly closed.
- Before each use, check the condition of the cable insulation, the unit and the accessories. All elements on which the insulation is damaged (even partially) must be put out of service for repair or disposed of as waste.
- Use cables and accessories for voltages according to IEC 61010-031 and measurement categories at least equal to those of the instrument.
- Respect the environmental conditions of use.
- Strictly comply with the fuse specifications. Disconnect all cables before opening the fuse access cover.
- Do not modify the instrument and do not replace components using equivalent parts. Repairs and adjustments must be carried out by qualified, approved personnel.
- Replace the battery as soon as the  symbol appears on the display. Disconnect all cables before opening the battery access cover.
- Use personal protection equipment when conditions require it.
- Do not place your hands close to instrument terminals that are in use.
- When handling sensors or test probes, do not place fingers beyond the physical finger guard.

MEASUREMENT CATEGORIES

CAT II: Test and measurement circuits directly connected to points of use (power outlets and other similar points) on the low-voltage network.

E.g. Measurements on circuits in network for household appliances, portable tools and other similar instruments.

CAT III: Test and measurement circuits connected to parts of the building's low-voltage network installation.

E.g. Measurements on distribution switchboards (including secondary meters), the circuit breakers, cabling including cables, busbars, junction boxes, circuit breakers, power outlets in the fixed installation and industrial instruments and other equipment such as motors permanently connected to the fixed installation

CAT IV: Test and measurement circuits connected to the source of the building's low-voltage network installation.











E.g. Measurement on equipment installed upstream of the main fuse or building installation cut-off switch.

You have just purchased a **C.A 5273** multimeter and we thank you for your confidence in our products.

To obtain the best service from your instrument:

- **Read** these instructions carefully;
- **Respect** the precautions for use.

Meanings of the symbols used on the instrument.

	Danger hazard: The operator undertakes to consult these instructions each time this danger hazard symbol is encountered.
	Fuse
	9V Battery
	The CE marking certifies compliance with European directives.
	Double or strengthened insulation
	Waste sorting for the recycling of electric and electronic waste in the European Union
	AC - Alternating current
	AC and DC - Alternating and direct current
	Earth
	Risk of electric shock

CONTENTS

1. OVERVIEW	4
1.1 The display	4
1.2. The keys	6
1.3. The switch.....	6
1.4. The terminals	7
2. Use	7
2.1 First use	7
2.2 Starting up the multimeter	7
2.3 Turning off the multimeter.....	7
2.4 The stand.....	8
3. Functions.....	8
3.1 Switch functions.....	8
3.2 Key functions	13
4. Specifications	19
4.1 Reference conditions	19
4.2 Specifications of the reference conditions.....	19
4.3 Operating conditions.....	24
4.4 Construction specifications.....	24
4.5 Power supply	24
4.6 Compliance with international standards.....	25
4.7 Variations in the field of use	26
5. Maintenance	27
5.1 Cleaning.....	27
5.2 Replacing the battery.....	27
5.3 Replacing the fuse	27
5.4 Metrology verification.....	27
5.5 Repair	27
6. Warranty	28
7. To order	28

1. OVERVIEW

The C.A 5273 is a stand-alone portable digital multimeter specially designed to combine all the functions for measurement of the following electrical quantities in a single instrument:

- AC voltage measurement with low input impedance (voltage measurements for electrical and electrical engineering applications)
- AC or DC voltage measurement with high input impedance (voltage measurement for electronics)
- Frequency measurement
- Resistance measurement
- Audible continuity measurement
- Measurement and testing of semiconductor junctions
- Capacitance measurement
- AC or DC current measurement
- Temperature measurement in C ° or F ° by linearisation of the voltage on the terminals of a K thermocouple.

1.1 The display

The multimeter's display allows users to:

- Display the functions: ;
- Show an analogue view of the measured parameter by means of the bargraph;
- Read the data comfortably thanks to the backlighting.

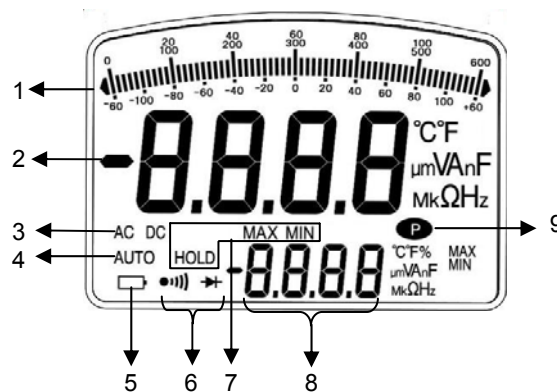







Figure 1 : the display

N°.	Function
1	Bargraph
2	Main display (values and measurement units)
3	Type of measurement
4	Selection of the measurement scale.
5	Low-battery indicator
6	Audible continuity measurement Measurement and testing of semiconductor junctions
7	Display of selected modes
8	Secondary display used for: <ul style="list-style-type: none"> ➤ voltage measurement ➤ current measurement ➤ temperature measurement ➤ MAX/MIN modes ➤ frequency measurement
9	Permanent mode: automatic instrument shut-down deactivated

1.1.1 The display symbols

Symbols	Description
AC	Measurement of the AC signal
DC	Measurement of the DC signal
AUTO	Auto-ranging
HOLD	Memorisation and display of memorised values
MAX	Maximum RMS value
MIN	Minimum RMS value
.run r.un ru.n	Capacitance meter, acquisition in progress
----	Frequency measurement impossible
O.L	Measurement capacities exceeded
V	Volt
Hz	Hertz
F	Farad
° C ° F	Degrees Celsius - Degrees Fahrenheit
A	Ampere
%	Percentage
Ω	Ohm
n	Symbol of the nano- prefix
μ	Symbol of the micro- prefix
m	Symbol of the milli- prefix
k	Symbol of the kilo- prefix
M	Symbol of the mega- prefix
	Audible continuity measurement symbol
	Symbol for measurement and testing of semiconductor junctions
	Permanent mode
	Low-battery indicator

1.1.2 Measurement capacities exceeded (O.L)

O.L (*Over Load*) is displayed when the measured signal exceeds the capacity of the instrument's scale. If the manual RANGE mode is active, press the  key to change the scale and then carry out the measurement.

There are two exceptions:

- 1000 V voltage range "OL" from 1050 V
- 10 A range "OL" from 20 A

1.1.3 Automatic change of measurement range

The **AUTO** symbol on the display indicates that the instrument automatically changes the measurement range to make the measurement. You can manually change the range by pressing .

1.2. The keys

The keyboard has 4 keys : MODE AC/DC, RANGE, MAX/MIN and HOLD. These are the keys:

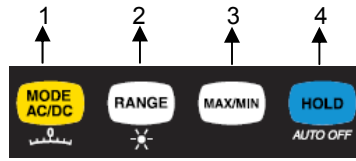



Figure 2: the keyboard keys

N°.	Function
1	Selection of the display mode (AC, DC, Hz, °C, °F et du bar-graphe ())
2	Selection of the measurement scale and activation/deactivation of the screen backlighting ()
3	Activation of the MAX/MIN mode
4	Memorisation of the values and display mode Activation or deactivation of the automatic instrument shut-down

1.3. The switch

The switch has 9 positions. The functions are described in the table below:

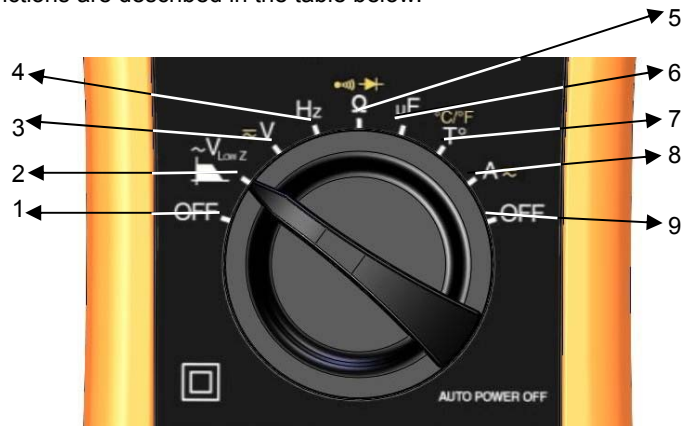

Figure 3: the switch

N°	Function
1 and 9	OFF Mode - Multimeter shut down
2	Voltage measurement with low impedance (V_{LowZ})
3	AC, DC voltage measurement with high impedance (V)
4	Frequency measurement (Hz)
5	Resistance measurement (Ω) Audible continuity measurement Diode test
6	Capacitance measurement (μF)
7	Temperature measurement (T°)
8	AC, DC current measurement (A)

1.4. The terminals

These are the multimeter terminals:

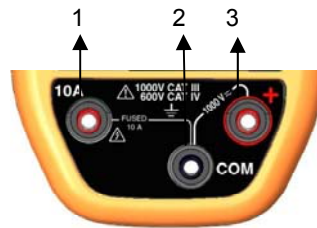

Figure 4: the terminals

N°.	Input
1	6 A, 10 A current
2	Common
3	Other measurements

2. USE

2.1 First use

Fit the battery shipped with the instrument as follows:

1. Using a screw driver, unscrew the four screws on the cover (item 1) located at the rear of the unit;
2. Place the battery in its housing (item 2) while respecting the polarity;
3. Screw the cover back on.

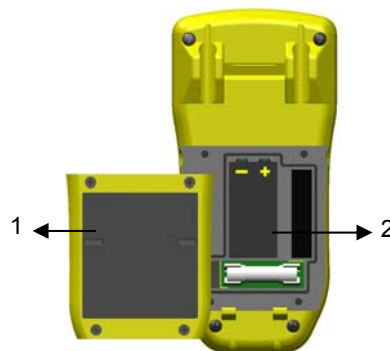



Figure 5: access to the battery

2.2 Starting up the multimeter

The switch is in the OFF position. Turn the switch to the function of your choice. All the display segments appear for a few seconds, then the screen for the selected function is displayed. The multimeter is now ready for measurements.

2.3 Turning off the multimeter

The multimeter can be turned off either manually by returning the switch to the OFF position, or automatically after ten minutes without use. After nine minutes an intermittent sound alarm is triggered until the instrument is shut down. Once the instrument is shut down, to reactivate it press the  key or turn the switch by at least one position. The latter method cancels the active functions.

2.4 The stand

There are two stand positions, one for suspending the multimeter (position 1) and the other providing a stand (position 2). To change the stand position, proceed as follows:

Position 1: fit the stand studs into the upper holes located on the rear of the unit:

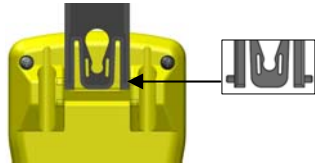

Position 2: fit the stand studs into the lower holes located on the rear of the unit:

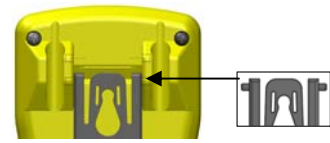

3. FUNCTIONS

3.1 Switch functions

To access the $\sim V_{LowZ}$, V_{AC} , Hz , Ω , μF , T° , or A_{AC} function, turn the switch to the selected function position. Every position (except OFF) is confirmed by a beep.

When the quantity V or A is selected, the multimeter is in AUTO AC/DC. It then determines whether the measurement is an AC or DC measurement. The larger component is the one displayed. You can deactivate this automatic function and force

AC or DC coupling by pressing the **MODE AC/DC** key. To reactivate the function, you must turn the switch and then set it to V or A again, depending on the case.

3.1.1 Types of measurements

Below are the possible combinations depending on the type of measurement:

Types of measurements	Max / Min		Auto/ Range
$V_{LowZ AC}$, V_{AC} , A_{AC}	✓	-	✓
V_{DC} , A_{DC}	✓	✓	✓
T°	✓	-	✓
Ω	✓		✓
μF	✓		✓
Hz	✓		✓

3.1.2 Voltage measurement

The instrument measures the following types of voltages:

- DC voltage with high impedance (DC);
- AC voltage with high impedance (AC);
- AC voltage with low impedance (V_{LowZ})

In all cases "O.L." displays in excess of 1050 V and a beep sounds when the measurement exceeds 600 V.





Volt



V_{LowZ} : This position is designed for measurements on electrical installations. The input impedance $< 1\text{ M}\Omega$ is used to avoid measuring "phantom" voltages caused by coupling between the lines. Thanks to the low pass filter, it is possible to measure the RMS voltage supplied by an MLI variable speed drive (for asynchronous motors).

⚠ In V_{LowZ} , the measurement signal goes through the low pass filter with a cut-off frequency of $< 300\text{ Hz}$. When measuring a voltage with a frequency in excess of 150 Hz, it is considerably reduced and therefore a significant error can occur. In this case the position  which uses the entire bandwidth should be used.

To measure a voltage, proceed as follows:

1. Set the switch to  or .
2. Select the type of signal (AC or DC) by pressing .
Depending on your selection, the screen will display AC or DC.
3. Connect the black lead to the **COM** terminal and the red lead to "+";
4. Place the test probes on the terminals of the circuit to be measured;
5. Read the measurement indicated on the display
6. By default, the 2nd display indicates the frequency, except for DC.

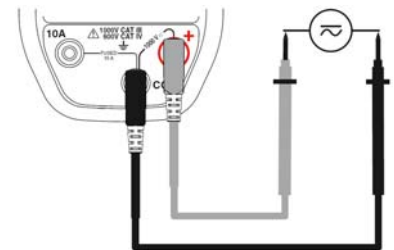

3.1.3 Frequency measurement

To measure the frequency, proceed as follows:

1. Set the switch to .
2. Connect the black lead to the **COM** terminal and the red lead to "+";
3. Place the test probes on the terminals of the circuit to be measured;
4. Read the measurement indicated on the display.

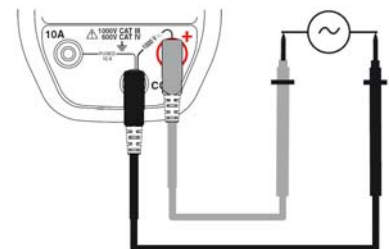

3.1.4 Resistance measurement

To measure the resistance, proceed as follows:

1. Set the switch to  ;
2. Connect the black lead to the **COM** terminal and the red lead to "+";
3. Place the test probes on the terminals of the component;

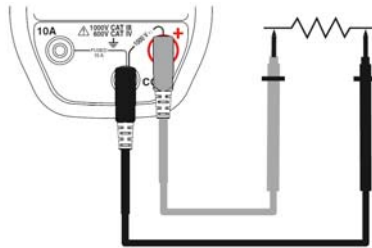

Remark: all resistance measurements must be performed with the power off.



4. Read the measurement indicated on the display.
5. "O.L." is displayed if the circuit is open.

3.1.5 Audible continuity measurement

For audible continuity measurement, proceed as follows:

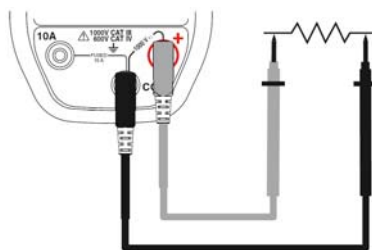

1. Set the switch to  ;
2. Press . The  symbol is displayed;
3. Connect the black lead to the **COM** terminal and the red lead to "+";
4. Place the test probes on the terminals of the circuit to be measured;



5. Read the measurement indicated on the display.
6. The continuity beep sounds when $R < 30 \Omega \pm 3 \Omega$.
7. "O.L." is displayed if the circuit is open.

3.1.6 Diode test

To measure and check a semiconductor junction, proceed as follows:

1. Set the switch to  ;
2. Press twice on . The  symbol is displayed;
3. Connect the black lead to the **COM** terminal and the red lead to "+";
4. Place the test probes on the terminals of the component;

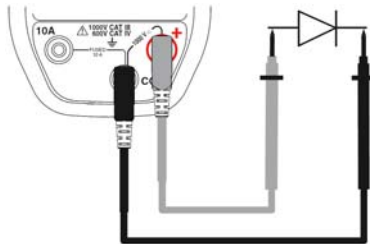

5. Read the junction threshold voltage measurement indicated on the display.
6. "O.L." is displayed if the circuit is open.

3.1.7 Capacitance measurement

To measure the capacitance, proceed as follows:

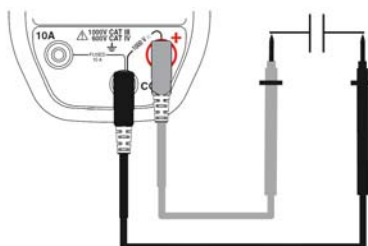

1. Set the switch to  ;
2. Connect the black lead to the **COM** terminal and the red lead to "+";
3. Place the test probes on the terminals of the component;



4. Read the measurement indicated on the display.
5. "O.L." is displayed if the value to be measured exceeds the capacitance of the range or if the capacitor is short-circuited.
 - For high values, the measurement cycle includes the display of "run" with a "rolling" decimal point. This indicates that acquisition is in progress: wait for the display of the digital result.
 - Prior discharge of very high capacitances helps to reduce the duration of the measurement.

3.1.8 Temperature measurement

To measure the temperature, proceed as follows:

1. Set the switch to  ;
2. Press  to select the unit and scale of the temperature (° C or ° F).

Remark: the default measurement unit displayed is ° C.

3. Connect the temperature sensor to the **COM** and **"+"** terminals respecting the poles;

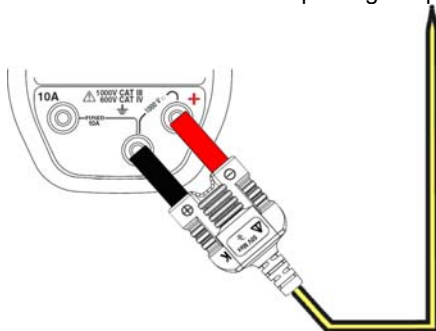



4. Read the measurement indicated on the display.
5. "O.L" is displayed the thermocouple is cut.

NB: For greater accuracy, avoid subjecting the instrument to sudden temperature changes.

3.1.9 Current measurement

To measure the current:

1. Set the switch to  ;
2. Select the type of signal (AC, DC) by pressing  . Depending on your selection, the screen will display AC, DC.
3. Connect the black lead to the **COM** terminal and the red lead to **"10A"**;
4. Place the test probes in series on the circuit between the source and the load;

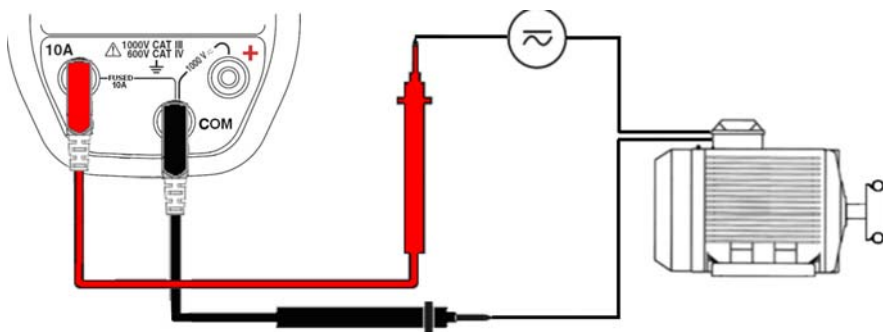

5. Read the measurement indicated on the display.
6. By default, the 2nd display indicates the frequency, except for DC.



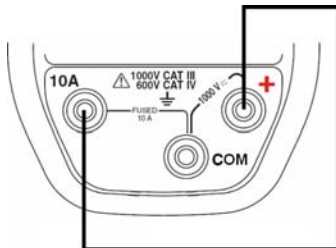

Detection of fuse tripping - or meltdown:

If the fuse has melted, the circuit between COM and the 10 A socket is cut. The display shows zero.















1. Set the switch to Ω .
2. Connect the V socket to the 10 A socket (see above); leave the "COM" socket free.
3. The display should show a result $< 2 \Omega$, otherwise replace the fuse.

3.2 Key functions

The functions: , , ,  can be accessed by pressing a key repeatedly, using short or long presses. The long-press function is shown by the pictogram under the key. The functions are not exclusive, they can be combined. It is therefore possible to have min/max peak relative or just relative. In the same way, the Hold mode does not stop the min/max peak surveillance, it only freezes the display. Every push on a key is validated by a sound signal.

3.2.1  Key

Choice of AC/DC coupling or of the bargraph style, or second keyboard function (yellow)



















Type of press		Resulting action
short on 	 	➤ changes the type of measurement : AC or DC.
		➤ selects: <ul style="list-style-type: none"> - audible continuity measurement  ; - measurement and testing of a semiconductor junction  ; - return to resistance measurement
		➤ displays the temperature in degrees Celsius ($^{\circ}C$) or degrees Fahrenheit ($^{\circ}F$).
long on  (> 2 sec)	 DC 	➤ displays the bargraph with graduation from zero to the full scale or from zero to central ().

3.2.2 Key









This key is used to manually select a measurement range or to activate the screen backlighting. The range defines the maximum range for measurements performed with the instrument.

Remark: the Auto Range mode is activated by default.

- *In normal mode*

Type of press		Resulting action
short on 	     	<p>➤ manually changes the measurement scale (extent and resolution).</p> <p><i>Example:</i> In  mode, the screen displays: 59.00 V, range Auto</p> <p>When pressed the first time, the screen displays: 59.00 V, manual range (60 V range) the second time: 59.0 V, manual range (600 V range) the third time: 59 V, manual range (1000 V range) the fourth time: OL mV, manual range (60 mV range) the fifth time: OL mV, manual range (600 mV range) the sixth time: OL mV, manual range (6 V range) the seventh time: 59.00 V, Auto range (60 V range) the eighth time: 59.00 V, manual range (60 V range)</p> <p>The default mode is AUTO for each selection of a measurement type V, A etc.</p>
long (> 2 sec) on 	      	<p>➤ activates or deactivates the backlighting () for the screen.</p>















• In  mode

Type of press		Resulting action
short on 	     	➤ exit from  mode.

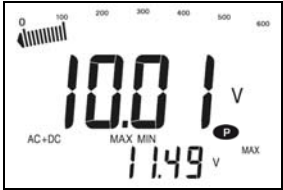
3.2.3 Key

This key displays the MAX, MIN modes. Max and Min fill in the highest and lowest values of the measurement.

- In normal mode**



















Type of press		Resulting action
short on 	    	<ul style="list-style-type: none"> enters the MAX/MIN mode. Note that  is displayed → in permanent operation. to select the quantities for MAX or MIN <p>Reminder: the MAX quantity is displayed by default. <i>Example:</i> display screen $\approx V / MAX$.</p> 
long (> 2 sec) on 	 	<ul style="list-style-type: none"> quits the  mode. <p>Remark: Auto power off is automatically activated.  off.</p>

- In  +  mode : refer to §. 3.2.4.









3.2.4 Key

This key is used to memorise the measurements and quantities or to deactivate the automatic power-off function on the instrument.

- In normal mode**

Type of press		Resulting action
short on 	       	<ul style="list-style-type: none"> ➤ memorises a measurement status at a given moment and then makes it possible to view them successively on the display. ➤ If activated, the Min Max acquisition continues as a background task. ➤ The bargraph continues to operate normally (even in Hold). ➤ In Hold, the   keys can be used,  ➤ exits from the  mode.
long (> 2 sec) on 	  	<ul style="list-style-type: none"> ➤ activates or deactivates the auto power-off function on the instrument (<i>AUTO OFF</i>). When 'auto off' is deactivated the  symbol is displayed. When auto power-off is activated, the display shows "APO on"; otherwise it displays "APO off". <div data-bbox="954 999 1238 1178" data-label="Image"> </div> <ul style="list-style-type: none"> ➤ When the automatic shut off, the second display will temporarily display "APO Off." ➤ When the automatic shutoff is activated, the second display will temporarily display "APO on."

- In  mode

Type of press		Resulting action
short on 	     	<ul style="list-style-type: none"> ➤ freezes the display of each MAX, MIN quantity displayed. MAX, MIN, acquisition continues in the background. This is indicated by blinking of the MAX, MIN symbols. ➤ If you press a second time, you quit the  mode.

4. SPECIFICATIONS

4.1 Reference conditions

Influencing quantities:	Reference conditions
Temperature	23° C ± 5° C
Relative humidity	45 % to 75 %
Power supply voltage	9 V ± 1 V
Frequency domain of the applied signal	40 Hz to 1 kHz
Absence of electric field	

4.2 Specifications of the reference conditions

Uncertainties are given in: $X \% \text{ of the reading (R)} \pm Y \text{ counts (D)}$.

When the frequency exceeds 1 kHz, apply the formula given in the tables
 $X \% R + Y \% \times [F \text{ (kHz)} - 0.4] R \pm D$.

where:

- Reading "R",
- Digit "D", the measurement count equivalent to the resolution of the display range,
- Frequency "F" in kHz.

4.2.1 DC voltages

▪ V DC

Range	Resolution	Uncertainty (±)	Input resistance
600 mV	0.1 mV	0.5 % R + 2 D	10 MΩ
6 V	0.001 V	0.2 % R + 2 D	
60 V (*)	0.01 V		
600 V	0.1 V		
1000 V	1 V		

(*) Input impedance $\approx 10 \text{ M}\Omega // 50 \text{ pF}$

4.2.2 AC voltages

- **V_{LowZ} AC position**

The bandwidth is reduced to 300 Hz - 3 dB. In V_{LowZ}, and there is no 60 mV scale. Frequency measurement is performed in the same way as the voltage measurement: with a bandwidth of 300 Hz

Range	Specified measurement range	Resolution	Uncertainty (±)	Additional uncertainty F(Hz) typ.	Input Impedance	Crest factor
600 mV	60 - 600 mV	0.1 mV	1.2 % R + 5 D	45 < F < 65 Hz : 0.3 % R at 100 Hz : 0.7 % R at 150 Hz : 1.8 % R at 300 Hz : 30 % R	520 kΩ // < 50 pF	3 at 500 mV
6 V	0.6 - 6 V	0.001 V	1.2 % R + 3 D			3 at 5 V
60 V	6 - 60 V	0.01 V				3 at 50 V
600 V	60 - 600 V	0.1 V				3 at 500 V
1000 V	60 - 1000 V	1 V				1.42 at 1000 V

- Secondary measurements and displays: frequency (AC coupling): Fmax ≤ 500 Hz, min max.

- **V AC True RMS position**

Range	Specified measurement range ²⁾	Resolution	Uncertainty (±)		Bandwidth	Input impedance	Crest factor
			40 to 400 Hz	0.4 to 3 kHz			
600 mV	60 - 600 mV	0.1 mV	1.2 % R + 5 D	1.2 % L + 0.5 % x [F(kHz) - 0,4] L + 5 D	40 Hz at 3 kHz	10 MΩ // < 50 pF	3 at 500 mV
6 V	0.6 - 6 V	0.001 V	1.2 % R + 3 D	1.2 % L + 0.5 % x [F(kHz) - 0,4] L + 3 D			3 at 5 V
60 V	6 - 60 V	0.01 V					3 at 50 V
600 V	60 - 600 V	0.1 V					3 at 500 V
1000 V ¹⁾	60 - 1000 V	1 V					1.42 at 1000 V

¹⁾ The display shows "+OL" in excess of +1050 V and "-OL" in excess of -1050 V or 1050 Vrms.

²⁾ From 1kHz, the measurement must exceed 15 % of the range

- Secondary measurements and displays: frequency (AC coupling): Fmax ≤ 3 kHz, min max.

4.2.3 Frequency

Special reference conditions :

$$150 \text{ mV} < U < 600 \text{ V}$$

$$0,15 \text{ A} < I < 10 \text{ A}$$

When the switch is on the Hz or Volts position, the 300 Hz filter is not operational.
 When the switch is in the V_{LowZ} position, the 300 Hz filter is activated for Volts and frequency

Range	600 Hz	6 kHz	60 kHz
Specified measurement range	10 - 600.0 Hz	0.01 - 6.00 kHz	0.01 - 10 kHz
Uncertainty (±)	0.1 % R + 2 D	0.1 % R + 2 D	0.1 % R + 2 D
Resolution	0.1 Hz	1 Hz	10 Hz

- Below 10 Hz, the value is forced to zero.
- If the detection level is insufficient, or if the current or voltage value is forced to zero, the freq. is not determined "-----".

4.2.4 Resistance

Special reference conditions: the input (+, COM) must not have been overloaded following the accidental application of voltage on the input terminals when the switch is on the Ω or T ° position. If this is the case, the return to normal can take about ten minutes.

Range	Specified measurement range	Resolution	Uncertainty (±)	Measurement current	Voltage in open circuit
600 Ω	0 – 600,0 Ω *	0,1 Ω	1 % R + 3 D	≈ 1 mA	< 5 V
6 kΩ	0 – 6,000 kΩ	0,001 kΩ	1 % R + 2 D	≈ 120 μA	
60 kΩ	0 – 60,00 kΩ	0,01 kΩ		≈ 12 μA	
600 kΩ	0 – 600,0 kΩ	0,1 kΩ		≈ 1,2 μA	
6 MΩ	0 – 6,000 MΩ	0,001 MΩ	1,5 % R + 3 D	≈ 120 nA	
60 MΩ	0 – 60,00 MΩ	0,01 MΩ	3 % R + 5 D	≈ 30 nA	

4.2.5 Audible continuity

Response time < 100 ms

Range	Resolution	Uncertainty (±)	Voltage in open circuit	Meas. current
600 Ω	0.1 Ω	Beep triggered < 30 Ω + 3 Ω	< 5 V	≈ 1 mA

4.2.6 Diode test

Range	Resolution	Uncertainty (±)	Voltage in open circuit	Meas. current
6 V	1 mV	Beep triggered < 40 mV + 10 mV	< 5 V	< 1,1 mA

4.2.7 Operation of the beep

Beep indicating a valid key → high sound	4 kHz, 100 ms
Beep indicating an invalid key → low sound	1 kHz, 100 ms
Successive beeps for 30 seconds ending with a long beep indicating that the instrument is being shut down → medium sound	2 kHz 100 ms
3 successive beeps with a space of 1 second in between (beep beep beep - gap - beep beep beep) indicating that the danger-level threshold has been exceeded → medium sound	2 kHz, 100 ms
2 successive beeps (beep beep) indicating MIN, MAX recording: → medium sound	2 kHz, 100 ms
Current > 10 A	4 kHz, 100 ms

4.2.8 Capacitance

Range	6 nF	60 nF	600 nF	6 µF	60 µF	600 µF	6 mF	60 mF
Specified measurement range	0,1-6,000 nF	0-60,00 nF	0-600,0 nF	0-6,000 µF	0-60,00 µF	0-600,0 µF	0-6,000 mF	0-60,00 mF
Uncertainty (±) *	2 % R +15 D	1 % R + 8 D	1 % R + 5 D	1 % R + 5 D	1 % R + 5 D	3 % R + 5 D	4 % R + 5 D	6 % R + 5 D
Resolution	0,001 nF	0,01 nF	0,1 nF	0,001 µF	0,01 µF	0,1 µF	1 µF	10 µF

(*) 0° C to 45° C

4.2.9 Temperature (K thermocouple)

Special reference conditions:

Internal heating can be caused by:

- the measurement of a high current over a long period
- overload of the + COM input when the switch is set to the T° position or Ω.

In this case, a certain waiting time is needed to return to the specified metrological conditions.

The multimeter must be at room temperature. Otherwise it may take up to 2 hours to return to the specified metrological conditions. If you do not wait, there will be a temperature offset, because the temperature reference of the cold junction is slightly altered. When in doubt it is possible to check the measurement of a known temperature (e.g. ambient) using the thermocouple.

Range	Resolution	Specified meas. range	Uncertainty (±)
low	0.1° C	- 50.9° C to 393.6° C	0.5 % R + 2° C
	0.1° F	- 4° F to 1000° F	0.5 % R + 4° F
high	1° C	50° C to 1200° C	0.5 % R + 2° C
	1° F	59° F to 2192° F	0.5 % R + 4° F

The accuracy announced for external temperature measurement does not take into consideration the accuracy of the K thermocouple.

There is no upper limit to the temperature display other than the display's 6000 D.

4.2.10 DC currents (10A DC)

Range	Resolution	Specified measurement range	Uncertainty (\pm)	Voltage drop	Protection
6 A	0.001 A	0.020 - 6.000 A	0.8 % R + 3 D	0.05 V / A	Fast fuse 10 A (or 11 A) /1000 V
10 A / 20 A *	0.01 A	0.200 - 20.00 A	0.8 % R + 2 D		

(*) Admissible overload: 10 A to 20 A for 30s max. with a 5 min pause between 2 measurements. Ambient temp. 35° C max.

4.2.11 AC currents (10A AC)

Reminder: the measurement uncertainty is specified for a display of between 550 and 6000 points. In the following tables, refer to the specified measurement range in which uncertainty is guaranteed.

Range	Resolution	Specified measurement range	Uncertainty (\pm)	Crest factor	Voltage drop	Protection
6 A	0.001 A	0.6 A to 6 A	40 Hz to 1 kHz 1.2 % R + 5 D	2.8 at 5 A	0.05 V / mA	Fast fuse 10 A (or 11 A) /1000 V
10 A *	0.01 A	1 A to 10 A	40 Hz to 1 kHz 1 % R + 3 D	3.7 at 8 A		

(*) Admissible overload: 10 A to 20 A for 30 s. max. with a pause of 5 min. between 2 meas. Ambient Temp. 35° C max.

4.2.12 Max/Min

Add 0.2 % + 2 D to the uncertainty of the function and of the range used to obtain the corresponding global uncertainty.

Extrema Capture time : 100 ms.

4.3 Operating conditions

Operating conditions	in use	in storage
Temperature	-10° C to 50° C	-20° C to 70° C
Relative humidity (RH)	≤ 80 % RH at 50° C	≤ 90 % RH (→ 45° C)

4.4 Construction specifications

Box	rigid case with yellow, elastomer thermo-adhesive over-moulding
Screen	LCD Display 63-element bargraph Backlighting
Keyboard	Keys: 4 function keys Switches: 9 positions, including 7 functions
Resolution	6000-count double display
Terminals	1 current connector (10A) 1 cold-point connector (COM) 1 connector for all measurements except amps (+)
Stand	to hold the instrument: <ul style="list-style-type: none">➤ in a position at 50° from horizontal➤ attached in a vertical position
Cover	to access the instrument's batteries and fuse
Dimensions	H 190 x W 90 x D 45 mm
Weight	400 g (with the battery and fuses)



4.5 Power supply

Battery life	> 150 hrs
Battery	9V 6F22
Auto power-off time	after 10 minutes without use
Power consumed in stand-by mode	< 5 µA
Low-battery indication threshold	6.3 V ± 0.3 V

4.6 Compliance with international standards

Electrical safety	Application of safety rules in compliance with standards NF EN 61010-1 + NF EN 61010-2-030 1000V, CAT III - 600V CAT IV, pollution level 2, double insulation.	
Electromagnetic compatibility	Compliance with the NF EN 61326-1 and NF EN 61326-2-2 standards Emission: class B Immunity: Electrical discharge: 4 kV on contact, aptitude criterion B; 8 kV in the air, aptitude criterion B Resistance to radiated fields: 10 V/m, aptitude criterion B Resistance to rapid transients: 1 kV, aptitude criterion B Conducted disturbances: 10 V/m, aptitude criterion A	
Mechanical strength	Free fall:	1 m (tested in compliance with the IEC 68-2-32 standard)
	Shocks:	0.5 J (tested in compliance with the IEC 68-2-27 standard)
Ingress protection	IP 54	in compliance with standard NF EN 60529

4.7 Variations in the operating range

Influencing quantity	Range of Influence	Influenced quantity	Typical	
			influence	MAX
Battery voltage	7.5 V to 10 V	all	< 1 D	0.2 % R + 1 D
Temperature	-10° C ... 18 28 ... 50° C	V DC mV	0.01 % R ± 0.2 D / 1° C	0.02 % R ± 0.25 D / 1° C
		VAC mV, V _{LowZ} mV	0.08 % R ± 0.2 D / 1° C	0.15 % R ± 0.25 D / 1° C
		V DC	0.01 % R ± 0.1 D / 1° C	0.05 % R ± 0.1 D / 1° C
		VAC and VAC+DC		0.15 % R ± 0.1 D / 1° C
		A DC	0.05 % R ± 0.1 D / 1° C	0.1 % R ± 0.1 D / 1° C
		AAC and AAC+DC	0.08 % R ± 0.1 D / 1° C	0.12 % R ± 0.1 D / 1° C
			0.01 % R ± 0.1 D / 1° C	0.1 % R / 1° C
		Ω	0.05 % R / 1° C	0.1 % R / 1° C
		60 MΩ		0.3 % R / 1° C
		μF		0.2 % R ± 0.1 D / 1° C
		mF		0.6 % R ± 0.1 D / 1° C
		Hz		0.01 % R / 1° C
		Temp.		± 2° C + 0.05 % R / 1° C
	Stabilisation time	≈ 90 min	2 hrs	
Humidity (without condensation)	10 %... 80 % RH	V A  Ω (*) Hz	0	0
Frequency	1 kHz... 3 kHz	V AC		4 % R
	3 kHz... 10 kHz			6 % R
Immunity to Radiated fields	80 to 1000 MHz 10 V/m	A range 10 A	300 D	900 D 120 MHz <Freq <170 MHz
	1000 to 2000 MHz at 3 V/m		50 D	Compliance with the standard: NF EN 61326 -1 and NF EN 61326-2-2
	2000 to 2700 MHz at 1 V/m		30 D	Compliance with the standard: NF EN 61326 -2-2 and NF EN 61326-2-2

(*) excluding the 60 MΩ range

5. MAINTENANCE

For maintenance, only use the specified spare parts.

5.1 Cleaning

- Unplug all connections from the instrument and place the switch in the OFF position.
- Use a soft cloth slightly moistened with soapy water. Rinse with a damp cloth and dry quickly with a dry cloth or pulsed air.
- Make sure no foreign bodies hinder the operation of the cable fitting system.

5.2 Replacing the battery

The  symbol indicates that the battery is low. When this symbol appears on the display, the instrument will operate for a further 20 hours before shutting down.

To replace the battery, proceed as follows:

1. Set the switch to OFF.
2. Disconnect the measurement cables from the input terminals.
3. Using a screwdriver, unscrew the four screws retaining the cover located behind the unit.
4. Replace the used battery.
5. Screw the cover back on.

5.3 Replacing the fuse

To replace the large fuse: size 10 x 38 type HRC, 10 A, 1000 V, 30 kA, proceed as follows:

1. Follow steps 1 to 3 of the procedure described above (§ 5.2).
2. Remove the defective fuses by levering them out of their housing with a screwdriver. Use the screwdriver to lever the fuses to extract the fuse.
3. Fit new fuse.
4. Screw the cover back on.

5.4 Metrology verification



Like all measuring or testing devices, the instrument must be checked regularly.

This instrument should be checked at least once a year. For checking and calibration, contact one of our accredited metrology laboratories (information and contact details available on request), at our Chauvin Arnoux subsidiary or the branch in your country.

5.5 Repair

For all repairs before or after expiry of warranty, please return the device to your distributor.

6. WARRANTY

Unless explicitly stated to the contrary, our warranty period is **three years** from the date the equipment is made available. Excerpt from our General Sales Terms and Conditions sent on request. The warranty will not apply in the event of:

- Inappropriate use of the equipment or use with incompatible equipment;
- Modifications made to the equipment without the explicit authorisation of the manufacturer's technical department;
- Work carried out on the instrument by a person not approved by the manufacturer;
- An adaptation for a specific application not specified in the definition of the equipment or not indicated in the operating instructions;
- Damage due to shocks, falls or flooding.

7. TO ORDER

- **The C.A 5273**

The multimeter is delivered with:

- Operating instructions on CD ROM in 5 languages
- Quick start guide in 5 languages
- Alkaline 6LF22 9 V battery
- One 1.5 m red straight/elbowed cable
- One 1.5 m black straight/elbowed cable
- CATIV 1 kV red test probe
- CATIV 1 kV black test probe
- Wire K thermocouple + adapter

- **Accessory**

Here is the available accessory :

- Bag 120 x 200 x 60 mm (Ref. P01298074)



03 - 2013
X03706D01 - Ed. 1

DEUTSCHLAND - Chauvin Arnoux GmbH

Straßburger Str. 34 - 77694 Kehl / Rhein
Tel.: (07851) 99 26-0 - Fax: (07851) 99 26-60

ESPAÑA - Chauvin Arnoux Ibérica S.A

C/ Roger de Flor N° 293, Planta 1- 08025 Barcelona
Tel.: 902 20 22 26 - Fax: 934 591 443

ITALIA - Amra SPA

Via Sant'Ambrogio, 23/25 - 20050 Bareggia di Macherio (MI)
Tel.: 039 245 75 45 - Fax: 039 481 561

ÖSTERREICH - Chauvin Arnoux GmbH

Slamastrasse 29 / 2 / 4 - 1230 Wien
Tel.: 01 61 61 961-0 - Fax: 01 61 61 961-61

SCANDINAVIA - CA Mätssystem AB

Box 4501 - SE 18304 TÄBY
Tel.: +46 8 50 52 68 00 - Fax: +46 8 50 52 68 10

SCHWEIZ - Chauvin Arnoux AG

Einsiedlerstraße 535 - 8810 Horgen
Tel.: 044 727 75 55 - Fax: 044 727 75 56

UNITED KINGDOM - Chauvin Arnoux Ltd

Waldeck House - Waldeck Road - Maidenhead SL6 8BR
Tel.: 01628 788 888 - Fax: 01628 628 099

MIDDLE EAST - Chauvin Arnoux Middle East

P.O. BOX 60-154 - 1241 2020 JAL EL dIB (Beirut) – LEBANON
Tel.: (01) 89 04 25 - Fax: (01) 89 04 24

CHINA - Shanghai Pu-Jiang - Enerdis Instruments Co. Ltd

3 F, 3 rd Building - N° 381 Xiang de Road - 200081 SHANGHAI
Tel.: +86 21 65 21 51 96 - Fax: +86 21 65 21 61 07

USA - Chauvin Arnoux Inc - d.b.a AEMC Instruments

200 Foxborough Blvd. - Foxborough - MA 02035
Tel.: (508) 698-2115 - Fax: (508) 698-2118

<http://www.chauvin-arnoux.com>

190, rue Championnet - 75876 PARIS Cedex 18 - FRANCE
Tel. : +33 1 44 85 44 85 - Fax : +33 1 46 27 73 89 - info@chauvin-arnoux.fr
Exportación: Tel. : +33 1 44 85 44 38 - Fax: +33 1 46 27 95 59 - export@chauvin-arnoux.fr