



IDE

Load break switches for machine control Remotely trippable switch from 32 to 160 A

Load break
switches



IDE 4x40 A
External operation



IDE 4x40 A
Direct operation

The solution for

- > Industry.
- > Non critical buildings.
- > Public Access Sites.
- > High Rise Buildings.



Strong points

- > Safety.
- > Easy to install.
- > Low consumption.

Empty enclosure for IDE

- > This drilled pre-equipped IP65 enclosure enables immediate installation of a direct control rear mounted IDE without auxiliary contact.



Function

IDE are manually operated multipolar load break switches with a remote tripping function.

They make and break under load conditions and provide safety isolation for any low voltage electric circuit, particularly for compliance with the machine directive.

General characteristics

- Positive break indication.
- IP2X protection with terminal shrouds (accessory).
- Shunt trip or undervoltage trip coil.

Advantages

Safety

Remote tripping is especially adapted for protection against automatic machine restart after isolation and restoration of the mains voltage (EN 60204.1 § 7.5).

Low consumption

The device coils (including undervoltage) have a low consumption, providing increased reliability.

Easy to install

As standard the IDE is supplied with its tripping coil factory fitted and with its connections made internally.

For IDE 125 and 160A a factory fitted auxiliary contact is supplied as standard, simplifying product installation. The various fixing systems (front or rear mount with direct or external operation) enable easy device implementation.

What you need to know

- **Direct** and **external operation** handles are available for the IDE.
- IDEs are supplied in 3 or 4 pole versions, with two mounting types available:
 - rear mounting on a **back-plate** or **DIN-rail**, direct or external operation.
 - **door** or **panel** mounting, direct operation.

Direct operation

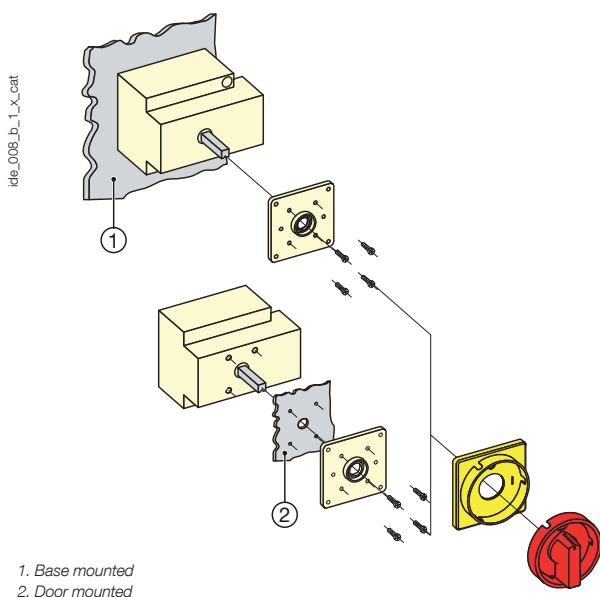

External operation

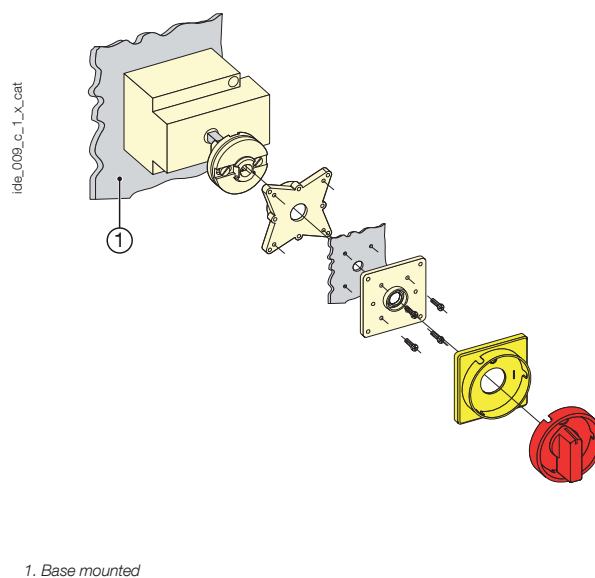

- Available in 230 or 400 VAC versions, the IDEs can be tripped remotely via a **shunt trip** or **undervoltage** coil. They are used to protect against automatic restarting and to prevent damage caused by the network malfunctions and is then re-established.
- Factory fitted, the IDE's tripping coil is connected internally. The coil is supplied between:
 - L1 and N for 230 VAC devices.
 - L1 and L2 for 400 VAC devices.
 For an IDE 32 A, an actuator relay can be incorporated between D2 and D14 (other wiring on request).

IDE 32 A

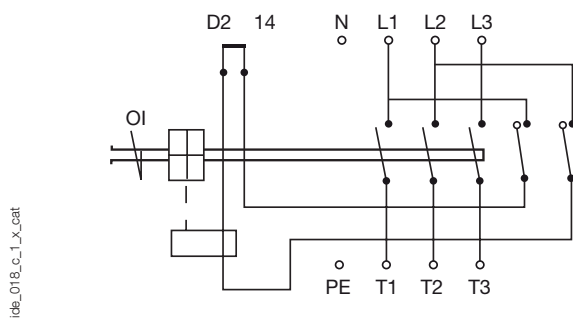

Internal cabling IDE 40 to 160 A

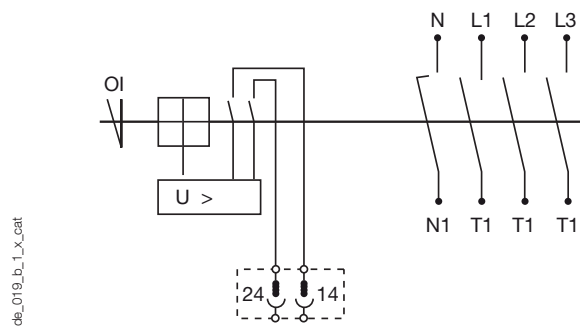

References

Base mounted

Rating (A)	No. of poles	Switch body Undervoltage coil	Switch body Shunt trip coil	Direct handle	External operation 200 mm	Position auxiliary contact	Terminal covers top/ bottom (2 sets)	Empty enclosure
32 A	3 P	1260 3003 ⁽¹⁾ 1270 3003 ⁽²⁾		Black IP65 1299 5012 Red / Yellow IP65 1299 5013	Black IP65 1299 6022 Red / Yellow IP65 1299 6023	1 contact NO+NC 1299 5001	3/4 P 1299 8003	1295 9001 ⁽⁵⁾
	4 P							
40 A	3 P	1260 3004 ⁽¹⁾⁽³⁾ 1270 3004 ⁽²⁾⁽³⁾	1280 3004 ⁽¹⁾⁽³⁾ 1290 3004 ⁽²⁾⁽³⁾	Black IP65 1299 6142 ⁽⁴⁾ Red / Yellow IP65 1299 6143 ⁽⁴⁾	Black IP65 1299 6032 Red / Yellow IP65 1299 6033	1 contact NO+NC 1299 0031	3/4 P 1299 8007	Please consult us
	4 P	1260 4004 ⁽¹⁾⁽³⁾ 1270 4004 ⁽²⁾⁽³⁾	1280 4004 ⁽¹⁾⁽³⁾ 1290 4004 ⁽²⁾⁽³⁾					
63 A	3 P	1260 3007 ⁽¹⁾⁽³⁾ 1270 3007 ⁽²⁾⁽³⁾	1280 3007 ⁽¹⁾⁽³⁾ 1290 3007 ⁽²⁾⁽³⁾					
	4 P	1260 4007 ⁽¹⁾⁽³⁾ 1270 4007 ⁽²⁾⁽³⁾	1280 4007 ⁽¹⁾⁽³⁾ 1290 4007 ⁽²⁾⁽³⁾					
125 A	3 P	1260 3013 ⁽¹⁾ 1270 3013 ⁽²⁾	1280 3013 ⁽¹⁾ 1290 3013 ⁽²⁾	Black IP65 1299 5032 Red / Yellow IP65 1299 5033	Black IP65 1299 6042 Red / Yellow IP65 1299 6043	1 contact NO+NC 1299 0021	3/4 P 1299 8013	
	4 P	1260 4013 ⁽¹⁾ 1270 4013 ⁽²⁾	1280 4013 ⁽¹⁾ 1290 4013 ⁽²⁾					
160 A	3 P	1260 3016 ⁽¹⁾ 1270 3016 ⁽²⁾	1280 3016 ⁽¹⁾ 1290 3016 ⁽²⁾					
	4 P	1260 4016 ⁽¹⁾ 1270 4016 ⁽²⁾	1280 4016 ⁽¹⁾ 1290 4016 ⁽²⁾					

(1) 230 VAC.

(2) 400 VAC.

(3) Modular device.

(4) Modular handle.

(5) This drilled pre-equipped enclosure enables immediate installation of a direct control rear mounted IDE without auxiliary contact, with protection rating of IP65.

Door mounted

Rating (A)	No. of poles	Switch body Undervoltage coil	Switch body Shunt trip coil	Direct handle	Auxiliary contact position	Terminal covers top/ bottom (2 sets)
32 A	3 P	1210 3003 ⁽¹⁾ 1220 3003 ⁽²⁾		Black IP65 1299 5012 Red / Yellow IP65 1299 5013	1 contact NO+NC 1299 5001	3/4 P 1299 8003
	4 P					
40 A	3 P	1210 3004 ⁽¹⁾ 1220 3004 ⁽²⁾	1230 3004 ⁽¹⁾ 1240 3004 ⁽²⁾	Black IP65 1299 5022 Red / Yellow IP65 1299 5023	1 contact NO+NC 1299 0031	3/4 P 1299 8007
		4 P	1210 4004 ⁽¹⁾ 1220 4004 ⁽²⁾			
	3 P		1210 3007 ⁽¹⁾ 1220 3007 ⁽²⁾			
63 A	4 P	1210 4007 ⁽¹⁾ 1220 4007 ⁽²⁾	1230 4007 ⁽¹⁾ 1240 4007 ⁽²⁾	Black IP65 1299 5032 Red / Yellow IP65 1299 5033	1 contact NO+NC 1299 0021	3/4 P 1299 8013
		3 P	1210 3013 ⁽¹⁾ 1220 3013 ⁽²⁾			
	4 P		1210 4013 ⁽¹⁾ 1220 4013 ⁽²⁾			
125 A	3 P	1210 3016 ⁽¹⁾ 1220 3016 ⁽²⁾	1230 3016 ⁽¹⁾ 1240 3016 ⁽²⁾	Black IP65 1299 5032 Red / Yellow IP65 1299 5033	1 contact NO+NC 1299 0021	3/4 P 1299 8013
		4 P	1210 4016 ⁽¹⁾ 1220 4016 ⁽²⁾			
	3 P		1210 3016 ⁽¹⁾ 1220 3016 ⁽²⁾			
160 A	4 P	1210 4016 ⁽¹⁾ 1220 4016 ⁽²⁾	1230 4016 ⁽¹⁾ 1240 4016 ⁽²⁾			

(1) 230 VAC.

(2) 400 VAC.

Accessories

Direct operation handle for base mounting

Rating (A)	Handle colour	External IP	Reference
32	Black	IP65	1299 5012
32	Red/Yellow	IP65	1299 5013
40 ... 63	Black	IP65	1299 6142 ⁽¹⁾
40 ... 63	Red/Yellow	IP65	1299 6143 ⁽¹⁾
125 ... 160	Black	IP65	1299 5032
125 ... 160	Red/Yellow	IP65	1299 5033

⁽¹⁾ Modular handle.

Direct operation handle for door mounting

Rating (A)	Handle colour	External IP	Reference
32	Black	IP65	1299 5012
32	Red/Yellow	IP65	1299 5013
40 ... 63	Black	IP65	1299 5022
40 ... 63	Red/Yellow	IP65	1299 5023
125 ... 160	Black	IP65	1299 5032
125 ... 160	Red/Yellow	IP65	1299 5033

External operation for rear mounting device

Use

Standard shaft length: 200 mm.

Other lengths: Please consult us.

Shaft extension and black handle

Rating (A)	Shaft length (mm)	External IP	Reference
32	200	IP65	1299 6022
40 ... 63	200	IP65	1299 6032
125 ... 160	200	IP65	1299 6042

Shaft extension and red handle

Rating (A)	Shaft length (mm)	External IP	Reference
32	200	IP65	1299 6023
40 ... 63	200	IP65	1299 6033
125 ... 160	200	IP65	1299 6043

Position auxiliary contact
Use

1 NO+NC auxiliary contact for position 0 and I signalling.

Connection to the control circuit

By terminal.

Characteristics

Rating (A)	Contact type	Nominal current (A)
32 ... 63	NO + NC	12
125 ... 160	NO + NC	5



ide_023_b_1_cat

Rating (A)	Mounting	Contact(s)	Reference
32	by customer	1 NO+NC	1299 5001
40 ... 63	by customer	1 NO+NC	1299 0031
125 ... 160	by customer	1 NO+NC	1299 0021
125 ... 160	factory fitted	1 NO+NC	1299 0121

Terminal shrouds
Use

Top or bottom protection against direct contact with terminals or connection parts.

Top and bottom pair.

Rating (A)	Position	Reference
32	top / bottom	1299 8003 ⁽¹⁾
40 ... 63	top / bottom	1299 8007 ⁽¹⁾
125 ... 160	top / bottom	1299 8013 ⁽¹⁾

⁽¹⁾ Reference composed of 2 pieces.

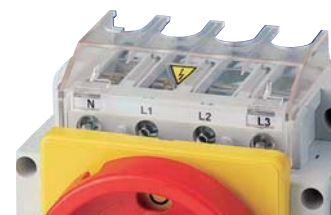

ide_035_a_1_cat

IP65 enclosure for direct operation IDE
Use

This drilled pre-equipped IP65 enclosure enables immediate installation of a direct operation, rear mounted IDE without auxiliary contact.

Rating (A)	Reference
32	1295 9001
40 ... 160	Please consult us

Characteristics

Characteristics according to IEC 60947-3

	IDE - 32 to 160 A				
Thermal current I_{th} (40 °C)	32 A	40 A	63 A	125 A	160 A
Rated insulation voltage U_i (V)	690	690	690	690	690
U_{imp} (kV)	6	6	6	6	6
Rated operational currents I_e (A)					
Rated voltage	Utilisation category	A/B ⁽¹⁾	A/B ⁽¹⁾	A/B ⁽¹⁾	A/B ⁽¹⁾
415 VAC	AC-20 A / AC-20 B	32/32	40/40	63/63	125/125
415 VAC	AC-21 A / AC-21 B	32/32	40/40	63/63	125/125
415 VAC	AC-22 A / AC-22 B	32/32	40/40	63/63	125/125
415 VAC	AC-23 A / AC-23 B	14/14	40/40	63/63	125/125
415 VAC	AC-3	14	30	44	100
690 VAC	AC-20 A / AC-20 B	32/32	40/40	63/63	125/125
690 VAC	AC-21 A / AC-21 B	32/32	40/40	63/63	125/125
690 VAC	AC-22 A / AC-22 B	13/13	32/32	40/40	125/125
690 VAC	AC-23 A / AC-23 B	4.9/4.9	17.5/17.5	21/21	42/42
Operational power in AC-23 A (kW)⁽²⁾					
415 VAC without pre-break AC	7.5	22	30	63	80
Operational power in AC-3 A (kW)⁽²⁾					
415 VAC without pre-break AC	7.5	15	22	55	55
Fuse protected short-circuit withstand (kA rms prospective)⁽³⁾					
Prospective short-circuit current (kA rms)	10	3	3	10	-
Associated fuse rating (A)	32	40	63	125	-
Short-circuit capacity (without protection)					
Rated short-time withstand current 1s. I_{cw} (kA rms)	1	1.5	1.5	2.5	2.5
I_{cm} (prospective kA peak)	3	5.2	5.2	6.6	6.6
Connection					
Minimum Cu cable cross-section (mm ²)	1	2.5	2.5	6	6
Maximum Cu cable cross-section (mm ²)	4	10	10	70	70
Tightening torque min/max (Nm)	1.2/1.5	2/2.5	2/2.5	6/12	6/12
Mechanical characteristics					
Durability (number of operating cycles)	100 000	50 000	50 000	30 000	30 000
Operating effort - 3 pole device (Nm)	0.35	0.38	0.45	1.6	2
Weight of a 3 pole device (kg)	0.26	0.35	0.39	1.35	1.45

(1) Category with index A = frequent operation - Category with index B = infrequent operation.

(2) The power value is given for information only, the current values vary from one manufacturer to another.

(3) For a rated operational voltage $U_e = 415$ VAC.

Dimensions

IDE 32 A

Direct operation with door or panel mounting

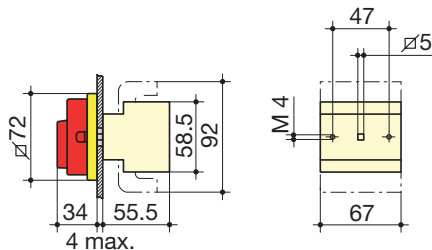

Direct operation with DIN-rail mounting

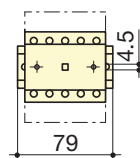
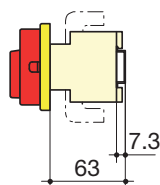

Door interlocked external front operation with DIN-rail mounting

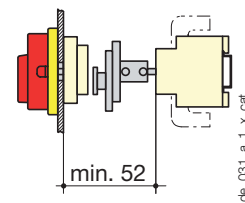

Enclosure for IDE 32 A

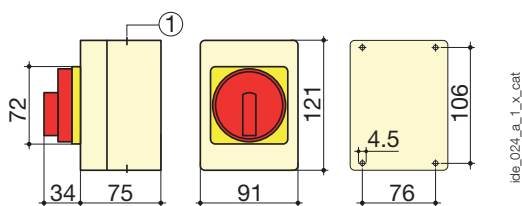

1. For PE 16 mm

IDE 40 to 63 A

Direct operation with door or panel mounting

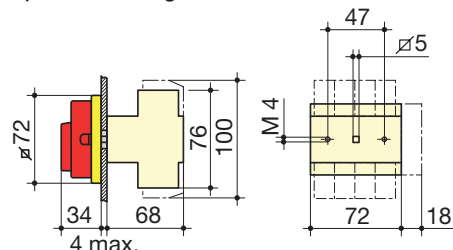

Direct operation with DIN-rail or back plate mounting

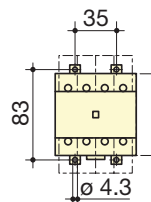
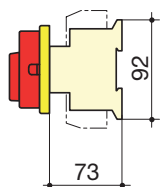

Door interlocked external front operation with DIN-rail or back plate mounting

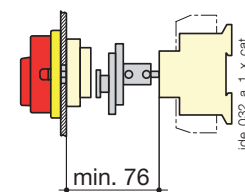

IDE 125 to 160 A

Direct operation with door or panel mounting

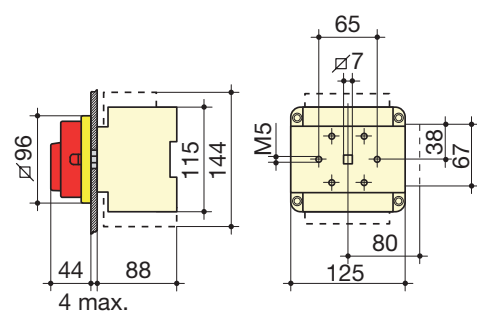

Direct operation with DIN-rail or back plate mounting

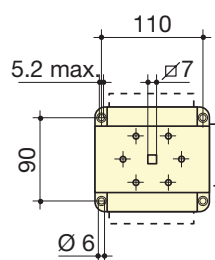
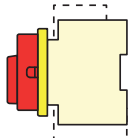

Door interlocked external front operation with DIN-rail or back plate mounting

