

Handheld multifunctional oscilloscope

MS300 and MS500 Series

User Manual

Shenzhen Micsig Instruments Co., Ltd

To customer,

Micsig MS300 and MS500 series handheld multi-functional oscilloscope includes oscilloscope, multimeter and recorder functions, which contains the following features:

- Complete electrical isolation between channels, with function of floating measurement
- Up to 190 k wfm/s waveform refresh rate (MS500 Series)
- 5.7 inch TFT LCD screen, 640*480 resolution, 16 bit color depth
- 8 bit AD acquisition. Display and measurement are more precise.
- Touch+Button+Scroll Wheel make handling better
- Quick drag and zoom on touch screen, quick operating response speed
- Serial bus trigger and decode, support UART(RS232/RS422/RS485), SPI, I2C, CAN, LIN, ARINC429, MIL-STD-1553B
- Dynamic recording, Detachable Li-ion battery
- HDTV trigger for 625/PAL, SECAM, 525/NTSC, SECAM, 720P, 1080I, 1080P (MS300 Series is optional, MS500 Series is standard)
- 31 kind of automatic measurements
- Support USB Host/Slave interface, which can plug U device or connect to the PC

Limited warranty and limitation of liability

All Micsig products are fully inspected before delivery and guarantee all comply with test criterion. As for warranty, please refer to product warranty card.

we authorized resellers shall extend this warranty on new and unused products to end user only but have no authority to extend a greater or different warranty on behalf of us.

Warranty support is available if product is purchased through an authorized sales outlet or Buyer has paid the applicable international price. We reserve the right to invoice Buyer for importation costs to repair/replacement parts when product purchased in one country is submitted for repair in another country.

Micsig's warranty obligation is limited, in Micsig's opinion, to refund of the purchase price, free of charge repair, or replacement of a defective product, which is returned to an authorized service center within the warranty period.

To obtain warranty service, contact your nearest Micsig authorized service center or send the product, with a description of the difficulty, postage and insurance prepaid (FOB destination), to the nearest authorized service center. Micsig assumes no risk for damage in transit. Following warranty repair, the product will be returned to buyer, transportation prepaid (FOB destination). If we determine that the failure was caused by misuse, alteration, accident or abnormal condition of operating or handling, we will provide an estimate of repair costs and obtain authorization before commencing the work. Following repair, the product will be returned to the buyer transportation prepaid, the buyer will be billed for the repair, and return transportation charges (FOB Shipping Point).

This warranty is Buyer's sole and exclusive remedy and is in lieu of all other warranties, express or implied, including but not limited to any implied warranty of merchantability or fitness for a particular purpose. We shall not be liable for any special, indirect, incidental or consequential damages or losses, including loss of data, whether arising from breach of warranty or scaled on contract, tort, reliance or any other theory.

Since some countries or states do not allow limitation of the term of an implied warranty, or

exclusion or limitation of incidental or consequential damages, the limitations and exclusions of this warranty may not apply to every buyer. If any provision of this warranty is held invalid or unenforceable by a court of competent jurisdiction, such holding will not affect the validity or enforceability of any other provision

Preface

Dear customers,

Hello! Firstly thanks for buying our instrument and for your proper use of this instrument, please read this manual before using it and particularly pay attention to "safety formation".

If you have finished readout this manual, we recommend you keep this manual for future reference.

CONTENT

CONTENT	1
CHAPTER ONE SAFETY INFORMATION	1
1.1 SAFETY INFORMATION	2
1.2 SAFETY NOTES AND SYMBOLS	3
CHAPTER TWO OSCILLOSCOPE QUICK START GUIDE	6
2.1 GENERAL CHECK	8
2.2 INTRODUCE THE NAMES OF INSTRUMENT'S PARTS	9
2.3 USE BRACKET	12
2.4 INSTALL AND REPLACE BATTERY	13
2.5 KNOW THE BUTTONS AND THEIR FUNCTIONS	17
2.6 TURN ON & TURN OFF	22
2.7 TURN ON OSCILLOSCOPE	22
2.8 GENERAL KNOWLEDGE OF USERS' INTERFACE	23
2.9 UNDERSTAND TOUCH SCREEN	28

2.10 FUNCTION TEST	31
2.11 PROBE COMPENSATION	33
CHAPTER THREE USE OSCILLOSCOPE.....	39
3.1 CHANNEL SELECTION	42
3.2 SET CHANNEL COUPLING MODE.....	43
3.3 SET CHANNEL SAMPLING MODE.....	46
3.4 BANDWIDTH SELECTION.....	50
3.5 USE DELAY	51
3.6 SET CHANNEL POLARITY	53
3.7 SET CHANNEL ATTENUATION RATIO	55
3.8 AUTO-CALIBRATION	57
3.9 SET AUTO MEASUREMENT TYPE.....	57
3.10 STORE/ RESTORE MENU.....	64
3.10.1 Save	64
3.10.2 Restore	66
3.10.3 Memory depth.....	68
3.10.4 Dynamic record.....	68
3.10.5 Store settings	74

3.10.6 Restore settings	74
3.11 CURSOR MEASUREMENT	75
3.12 SET DISPLAY MENU	80
3.12.1 Waveform settings	80
3.12.2 Graticule set	81
3.12.3 Persist adjustment	83
3.12.4 Time base	84
3.12.5 Adjusting refresh rate	86
3.13 SET TRIGGER MENU	87
3.13.1 Edge trigger	90
3.13.2 Pulse width trigger	95
3.13.3 Logic trigger	98
3.13.4 Video trigger	103
3.13.5 Serial bus trigger	107
3.15 USE AUTO SET	111
3.16 USE MATH MENU	112
3.18 REFERENCE CHANNEL	120
3.19 USE 50% SHORTCUT	120

3.20 USE TOUCH SCREEN ZOOM WAVEFORM	124
CHAPTER FOUR SERIAL BUS TRIGGER& DECODE	127
4.1 UART (RS232/RS422/RS485) BUS TRIGGER AND DECODE	130
4.2 LIN BUS TRIGGER AND DECODE	142
4.3 CAN BUS TRIGGER AND DECODE	149
4.4 SPI BUS TRIGGER AND DECODE	159
4.5 I2C BUS TRIGGER AND DECODE	166
CHAPTER FIVE APPLICATION EXAMPLES	176
5.1 TAKING SIMPLE MEASUREMENT	178
5.2 CAPTURE SINGLE PULSE SIGNAL	183
5.3 ANALYZE THE SIGNAL DETAIL	186
5.4 TRIGGER ON VIDEO SIGNAL	190
5.5 USE MATH FFT	192
CHAPTER SIX USE MULTIMETER	194
6.1 MULTIMETER SAFETY INFORMATION	196
6.2 START MULTIMETER	197

6.3 MULTIMETER BUTTONS AND THEIR FUNCTIONS	197
6.4 USE MULTIMETER	202
CHAPTER SEVEN USE RECORDER	205
7.1 START RECORDER.....	207
7.2 RECORD.....	207
7.2.1 Multimeter record	208
7.2.2 Oscilloscope measurement record	215
7.2.3 Oscilloscope waveform record	219
7.2.4 Store mode set	223
7.3 PLAYBACK	225
7.3.1 Multimeter record playback	225
7.3.2 Oscilloscope measurement record replay	229
7.3.3 Oscilloscope waveform replay	231
7.3.4 The last record playback.....	233
CHAPTER EIGHT USERS' SECTION	234
CHAPTER NINE SCOPESUITE SOFTWARE	248

CHAPTER TEN TROUBLESHOOTING 250

CHAPTER ELEVEN SERVICES AND SUPPORT 254

APPENDIX 258

APPENDIX A: TECHNICAL SPECIFICATIONS..... 259

APPENDIX B: MAINTENANCE OF OSCILLOSCOPE..... 271

APPENDIX C: FACTORY DEFAULT..... 274

APPENDIX D: ATTACHMENT 283

INDEX..... 285

Chapter One Safety Information

Read First

1.1 Safety information

To avoid personal injury and prevent from damaging products or other related devices, customer should read safety information and use this product in accordance with the relevant provisions.

- Please do not connect USD device when doing floating measurement
- Only trained personnel can operate maintenance procedure
- Avoid fire and personal injury
- Properly connect instrument probes
- View all terminal ratings. In order to avoid fire and excessive current impact, please refer all the ratings and marks of the product specifications
- Do not operate the instrument with the cover removed or the case opened.
- Replace the battery in the specified method, choose the specified power adapter and recommended battery for charging.

- Charge the battery properly. Please use the specified power adapter and recommended charging period, assure adapter connected to the outlet before connected to instrument.
- Avoid body contact with the exposed circuit directly
- Store under the floating air
- Do not use in damp or wet environment
- Do not use in flammable and explosive environment
- Keep the instrument's surface dry and clean

1.2 Safety notes and symbols

Safety notes in this manual. Below safety notes and symbols will be seen throughout this manual.



Warning denotes a hazard. It calls attention to all conditions and actions may result in injury or loss of life.

 **Caution** denotes a hazard. It calls attention to all conditions and actions may result in damage or destruction of the instrument.

Safety notes on product

Danger means while you are in violation of the provisions of this tag may immediately cause damage to you

Warning means while you are in violation of the provisions of this tag may not immediately cause damage to you.

Caution means cause damage to the product or others.

Symbols on products



Hazardous voltage



Refer to the manual



Protective earth terminal



Chassis ground



Test ground

Please read the following safety information to avoid personal injury and prevent products or damage related products. In order to avoid the possibility of danger, this product can be used in the specified manner only.



Warning

To avoid electrical shock or fire if a product input is connected to more than **42Vpp (30 V rms) or on the circuit of more than 4800VA:**

- *Please use the pens and voltage probes provided by the instrument, or use the standard products in the accessory description*
- *Before using, inspect voltage probes , test pens and accessories from mechanical which may be damaged, please choose new proper accessories*
- *Remove all probes, test leads and accessories if you do not want to use them.*

Chapter Two Oscilloscope Quick Start Guide

This chapter will guide you how to operate oscilloscope, it contains the following contents

- General check
- Introduce the names of the instrument's parts
- Use bracket
- Install& replace battery
- Introduce buttons and their functions
- Turn on /off
- Turn on oscilloscope
- Basic knowledge of oscilloscope user interface
- Understand touch screen
- Function test
- Probe compensation

2.1 General check

When you receive your product, please check the instrument according to the following instruction.

1. Check if damage caused by transportation.

Please keep the packaging until the whole instrument and accessories pass through electronic performance and mechanical test.

2. Check the accessories

Each oscilloscope has a packing list. You can refer it to check if the attachment is complete. If the attachment is missing or damaged, please contact Micsig's agent or local office.

3. Check the instruments

If situation happens like, broken of appearance of the oscilloscope, or failure to pass the performance taste, please contact Micsig's agent or local office which is responsible for this business. If the instrument damaged by transportation, please

refer to the packing case and contact with Transportation Company and our Agent, we will arrange repair or replacement.

2.2 Introduce the names of instrument's parts

Top components and connectors: From top view of the instrument, you can see the probe input, multimeter test pen line input and two rope connection, see below picture 2-1; The multimeter test pen line input also can apply to external source trigger and probe compensation.

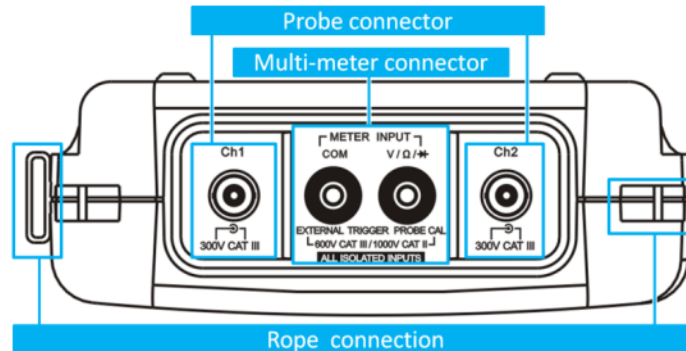

Picture 2-1 Top components and connectors

Introduce the names of instrument's parts

Left components and connectors: The handle and power jack. Refer to picture2-2.

External power jack: by special adapter to convert the alternating current (AC) to direct current (DC), then supply power for oscilloscope.

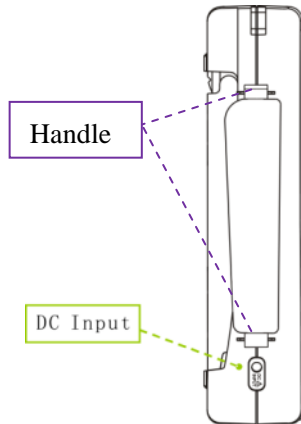

Picture 2-2 left components and connectors

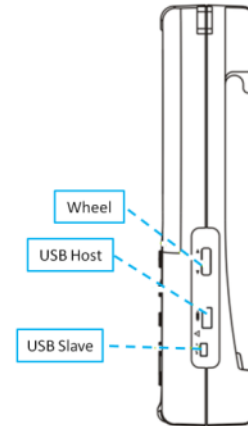

picture 2-3 right components

Right components: This includes a wheel and a USB port. Refer to picture 2-3.

Wheel: fast move oscilloscope trigger level, horizontal position, vertical position, the

Introduce the names of instrument's parts

cursor and to quick a djust the brightness of oscilloscope waveform, the intensity of graticule, afterglow and the trigger hold-off time. The usage of the wheel is shown in the following chapters.

Front panel: It includes the keyboard, LCD and touch panel. Refer to picture 2-4

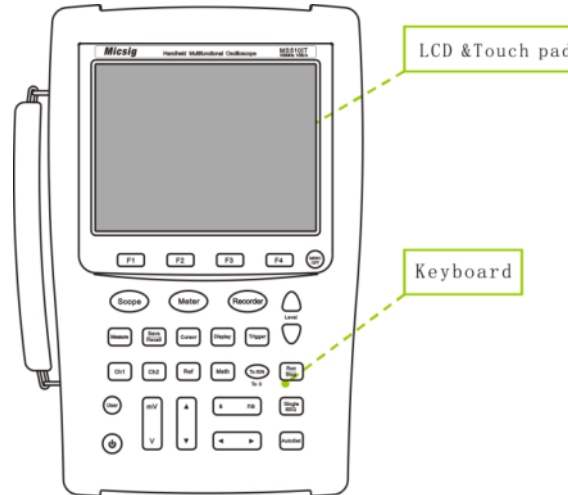

Picture 2-4 front panel

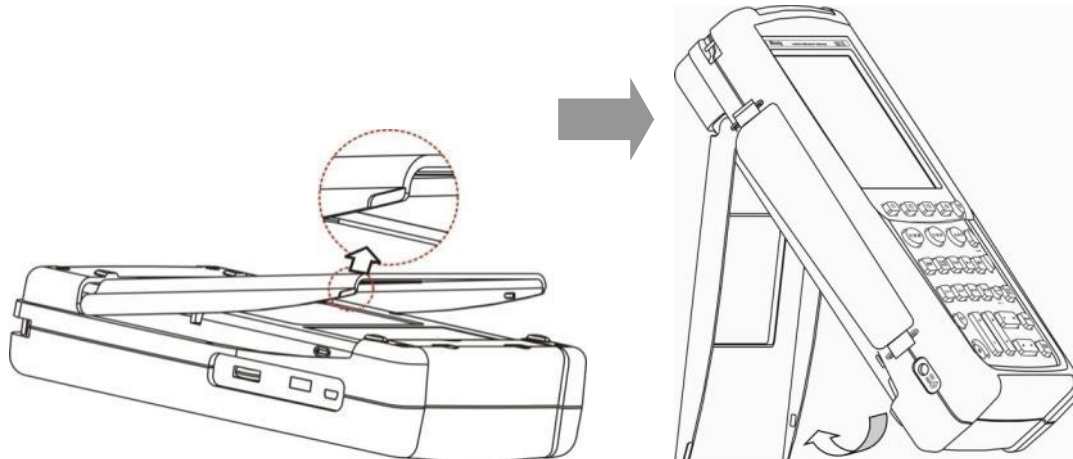

2.3 Use bracket

First flat front panel on the desktop and then use your both index fingers to dig it out from stern notch on either side of the bracket with little upward force. Shown as picture2-5, (circle zone indicts bracket stern north)



Picture2-5 open bracket

2.4 Install and replace battery

When using the battery, the upper right corner of the screen displays the battery icon () , which indicates the remaining battery power. When battery is in under -voltage threshold, battery icon flashes which means it should be replaced, if continue use, oscilloscope will automatic power off. At this moment user should use an external power adapter. When battery is not full, please plug in power adapter, so the battery in charging status, If battery is full or use power adapter only, the upper right corner of screen shows power in-charging icon(). Turn off channels that are not in use, lower the screen background brightness and reduce the memory depth or refresh rate to lower power consumption.

Steps for installing battery

1. Open the bracket, refer to picture 2-6①
2. Put the battery into the compartment and push the battery from bottom up until

the battery completely push to the top housing, refer to picture 2-6②

3. Insert the battery baffle, refer to picture 2-6③

4. Close the bracket, refer to picture 2-6④

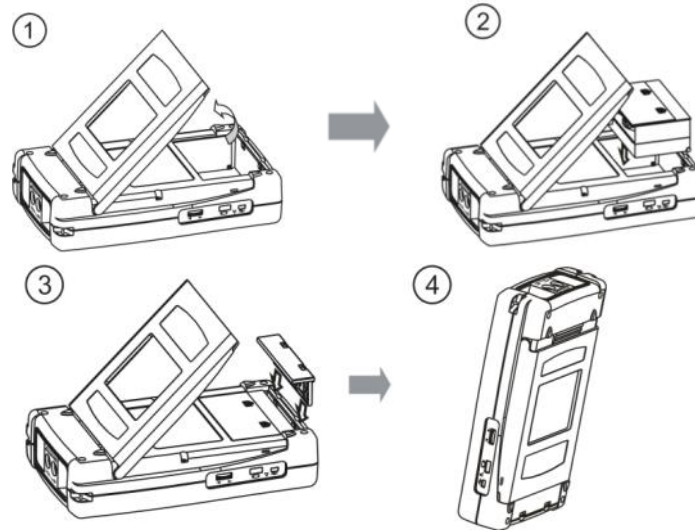

Picture2-6 Steps for install battery

Steps for removing battery

1. Open bracket, refer to picture 2-7①
2. Use fingers to dig up the lock chip from each side with some strength to pull up the battery baffle, refer to picture 2-7②
3. Press the battery fingerprint parts down and pull the battery to the bottom of the battery compartment, refer to picture 2-7③
4. Level up the rear panel and the battery automatically slides out under the gravity, refer to picture 2-7④
- 5.

Install and replace battery

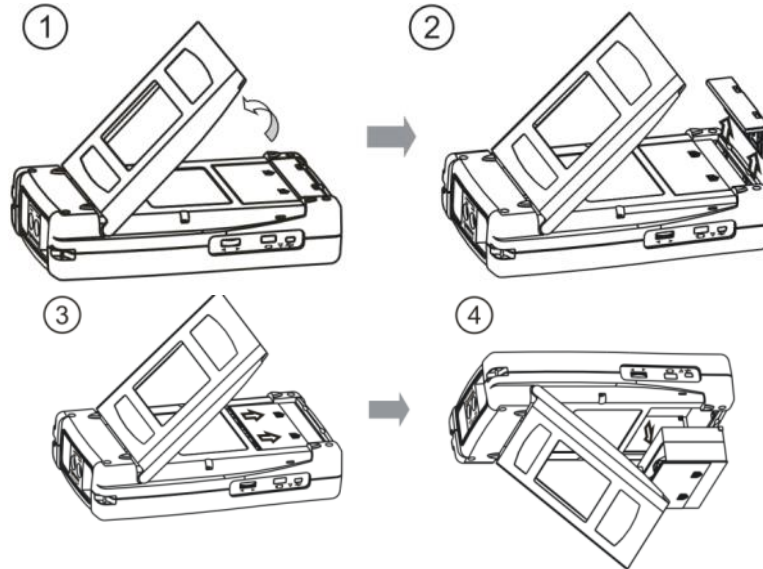

Picture 2-7 Remove battery

Notes: For the first use or long time no use, users should charge the battery before using it.

2.5 Know the buttons and their functions



_____ Turn on oscilloscope function and open menu under the oscilloscope mode



_____ Turn on multimeter function



_____ Turn on recorder function



_____ Function button menu, corresponding to the function shown in the bottom screen



_____ Function button menu, corresponding to the function shown in the bottom screen





_____ Functional button menu, corresponding to the function shown in the

bottom screen

 _____ Functional button menu, corresponding to the function shown in the

bottom screen

 _____ Menu off or return on the menu

 _____ Adjust trigger level forward, adjust the parameters in the current menu item or move the cursor etc.

 _____ Adjust trigger level backward, adjust the parameters of the menu options and move the cursor etc.

 _____ System function button, for system configuration and etc.

 _____ Power button, turn on/off oscilloscope

 _____ Function button, open the auto-measurement menu

Know the buttons and their functions



_____ Function button can turn on store& recall menu



_____ Turn on cursor menu



_____ Function button to open display menu



_____ Function button to turn on trigger menu



_____ Stop or restart the waveform capture, or lock screen in multimeter mode



_____ Function button trigger and capture one single waveform then sop,

press  button to escape this mode





_____ Function button, which can automatically adjust the vertical scale, vertical position and horizontal time base, making the waveform display as the best effect.

Know the buttons and their functions

 _____ Function button, 50% shortcut button which can move the waveform to the center of the screen, or make the trigger voltage to the center of the waveform amplitude

 _____ Open / close the Ch1 or set Ch1 as current channel

 _____ Open / close the Ch2 or set Ch2 as current channel

 _____ Function button, open the reference menu and select the reference waveform (user can choose four reference waveforms which displayed on the screen at a time)

 _____ Function button, open or close the math channel, and set math channel as current channel.

Know the buttons and their functions



_____ Function button; adjust the vertical scale of the selected channel



_____ Function button, vertical position adjustment button, move the vertical position of the selected waveform



_____ Function button, adjust the horizontal scale (horizontal time base)



_____ Function button, horizontal position adjustment, waveform horizontal movement





_____ Wheel, quick adjust the trigger level, the cursor, or move waveform, or used in parameter setting

2.6 Turn on & turn off

Press power button  to turn on instrument, repress this button to turn off, long press this button for 3 seconds can forcedly shut off the instrument.

 **warning:** Shut off this instrument may cause data loss.

2.7 Turn on oscilloscope

Turn on the instrument then enter the oscilloscope mode (as the default mode). If the instrument is in multimeter or recorder mode, press  key to switch to oscilloscope-mode. When the instrument in scope work mode, the keyboards are all available and press these buttons, you can open a menu or switch some sort of functions directly. For example, under oscilloscope mode, press  to open main menu.

2.8 General knowledge of users' interface

This section does a simple introduction and description to oscilloscope users' interface. After reading this section, you can be familiar with the oscilloscope display interface in a short time. For the specific settings and adjustments, users can refer Chapter Three. The screen items shown in the following picture may not appear on the same screen simultaneously, the users' interface is shown in figure 2-8.

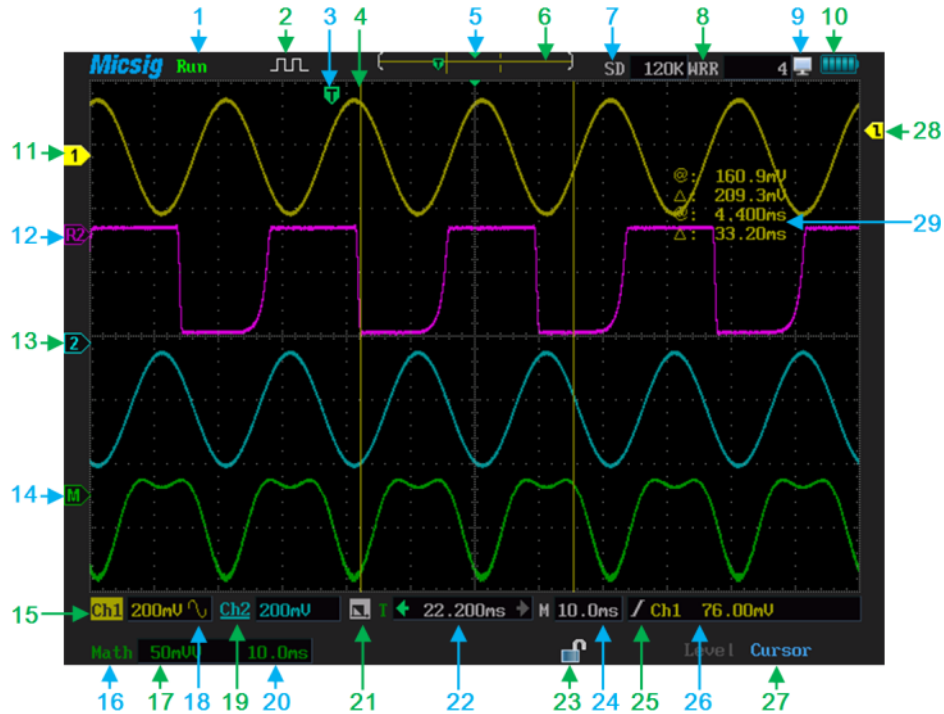

Picture 2-8 Users' interface

Users' interface:

1. There are five kinds of wave capturing mode indicator:

Auto: in auto mode, according the input signal to automatically adjust the vertical scale, the horizontal time scale, and the trigger mode to make the waveform displays as the best.

Run: Acquire waveform data

Stop: Stop acquiring waveform data

Waiting trigger: a transient state just before trigger event occur

Rolling: Acquire waveform data when scroll the touch screen

2. The probe calibration related square wave output indicator

3. The trigger position icon indicates the waveform trigger position

4. The cursor can be divided into vertical cursor and horizontal cursor, used for measuring cursor

5. The extension position icon, the center point of the time base zooming out

6. Waveform position indicator, indicate the position of waveform on current screen between the total sampling data.

7. Memory depth, the current channel memory depth is 120 k

8. Refresh rate, actual wfm/s at right value

9.  USB connection icon, which means connect it to PC currently.

10. User can view the battery charge status in the following ways



Connected to external power



power capacity remaining



battery full,



battery under-voltage

11. Display Ch1 zero position, the point is solid, which indicates Ch1 as current channel, and the pointer color is same as the waveform color.

12. Reference waveform icon: When the pointer is solid, indicating the reference waveform is current waveform.

113. Ch2 zero position, when the pointer is hollow indicating Ch2 is not the current channel.

14. Math channel icon, when the pointer is solid indicating the math channel is the current channel.

15. Ch1, reverse color of Ch1 means Ch1 is the current channel and the right reading 1.00 V means vertical scale of Ch1

16. Math channel, reverse color of math channel means math channel as current channel

17. Math channel, the reading 50 mv means vertical scale of math channel

18. Coupling mode information, here indicates the Ch1 as AC coupling sample. Coupling examples



Ac coupling sample



ground

If there is no icon displayed in arrow 18, it is a DC coupling sample.

19. Ch2, here the underline means this channel inverted open, the reading 200 mV is vertical scale of Ch2.

20. Current in FFT mode, frequency span per grid is 20Hz

21. The bandwidth limit icon  that means Bandwidth is limited to 20MHz (3db), no icon if full bandwidth

22. The value indicates the relative trigger position of current channel, the green arrow next to the readout means the trigger position deviating from the center to the left or right

23. Screen lock/unlock, lock screen off the touch function, unlock the screen opening touch function.

24. Horizontal scale (horizontal time base)

25. Trigger condition icons,  rise trigger,  fall trigger,  dual edge trigger

26. Set trigger level value, on the left side of the Ch1 is current trigger source

27. Trigger level, cursor switch indicator



28. Trigger level position, when logic trigger happens there are two pointers, the yellow one is Ch1 trigger level, and blue one is Ch2 trigger level.

29. Value of cursor measurement

2.9 Understand touch screen

1. The touch screen function menu

When the function menu opened, you can directly press the touch screen to select menu. Set the "coupling" as GND, please follow these steps,

- 1) Press  to open the main menu
- 2) Press "coupling"
- 3) Press touch screen to select coupling as GND; As shown in picture2-9
- 4) Press  to close function menu then the set is finished.

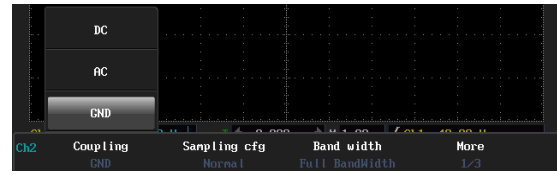

Picture 2-9 Menus on touch screen

2. Five operating areas on the touch screen

Frames of the waveform display divide the touch screen into five areas, only the function menu turned off, can operate these areas. See figure 2-10.

Touchable area description:

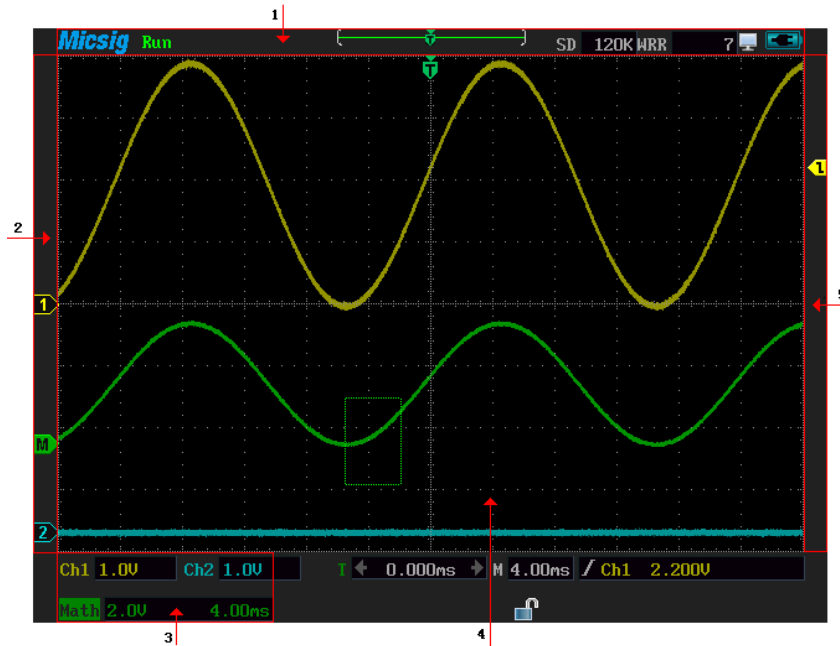

1. Horizontal drag area: From the upper waveform window to screen top. You can move waveform horizontally in this area.
2. Vertical drag and the current channel selection area: where the waveform displays from the left frame to the right frame. Press the channel icon switch to the current channel, vertical drag only applies to the current channel.
3. Current channel switch area: press the frame corner at Ch1, Ch2, Math, or Ref and users can switch one of them to the current channel.
4. Waveform zoom area: the whole waveform display area can be used as waveform zoom in/out area.
5. Trigger level and drag the cursor area: the area between waveform window's right edge and screen's right edge where users can move the trigger level or drag the cursor.



Picture 2-10 touch area

2.10 Function test

Testing the instrument to make sure whether it is working normally. Please follow these steps for simple function test

- 1) Connect the instrument to external power jack, press  to turn on, to see whether the top right corner of screen has a charging icon.
- 2) Put the probe slot to the Ch1 BNC jack, slightly insert and rotate the slots tighten clockwise direction.
- 3) Connecting the (10 x) probe to the sine wave signal source (10V, 50 Hz)
- 4) Press  to display signal waveform. View picture 2-11.
- 5) Switch to the Ch2, and connect the probe to the Ch2, and repeat the step3 and 4.

If find the waveform display abnormal during the function test, please refer to the troubleshooting Chapter or contact with Micsig after-sales service center.

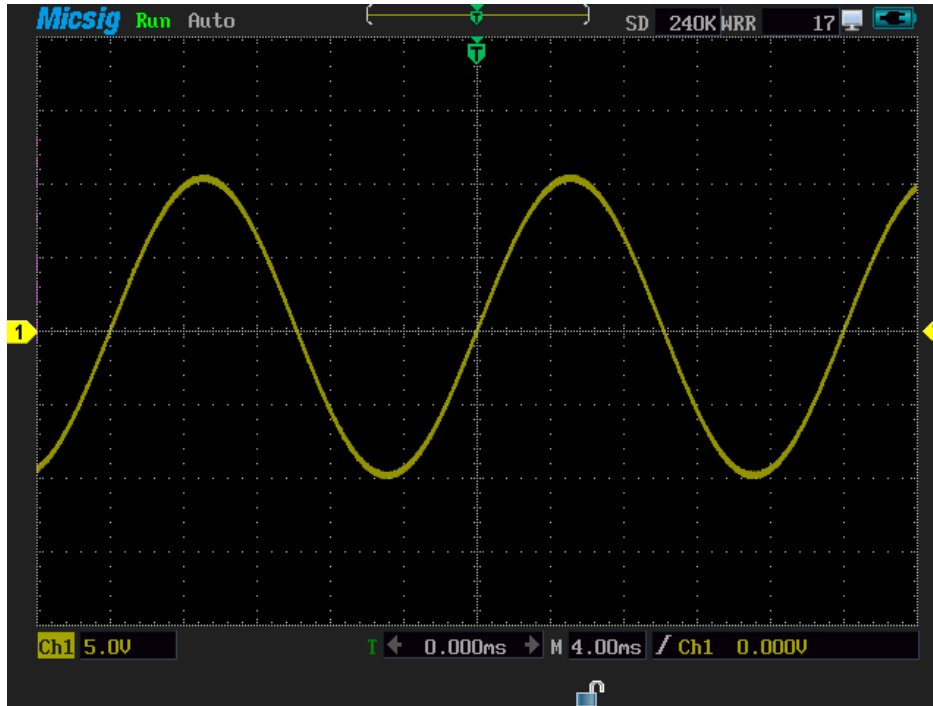

Picture 2-11 Sine waveform (10V, 50Hz)

2.11 Probe compensation

Before connecting to any channels, users should make a probe compensation to insure the probe match the input channel. The probe without compensation will lead to larger errors or mistakes, and probe compensation optimizes the signal path and makes measurement more precise. If the temperature is 10 degree centigrade or above, this progress must be done to insure the accuracy of the measurement. See picture 2-12



Picture 2-12 Probe compensation menu

Procedures of probe compensation as follow

- 1) Connect the oscilloscope probe to Ch1. If you are using a hook head, users should ensure the good connection with the probe.

2) Press **Scope** then **F4** then **F4** and **F2**, set the probe calibration signal output as start, then at the top left corner the square wave screen icon is flashing, indicate square wave signal is output, see figure 2 to 13;

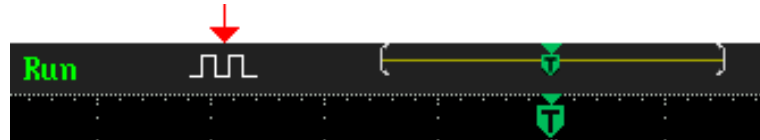

Picture 2-13 signal output of probe compensation

3) Put the banana plug into multimeter jack, and put the probe, which needs calibration to the banana head. See picture 2-14, press **AutoSet** to adjust the waveform display or manual adjustment, if necessary, users can repeat the above steps and observe the waveform, shown as picture 2-15, 2-16, 2-17.

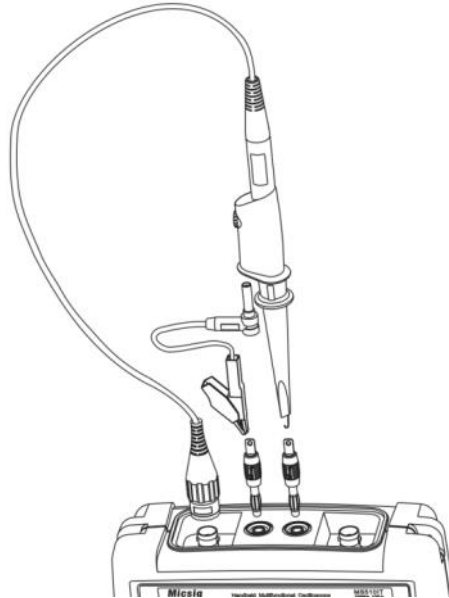

Picture 2-14 Probe compensation connection

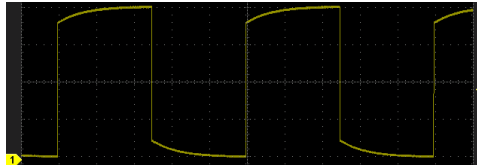

Picture 2-15 Under compensation

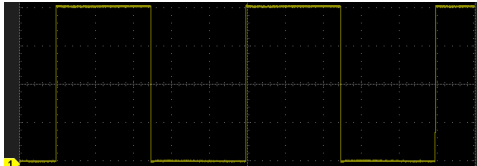

Picture 2-16 Correct compensation

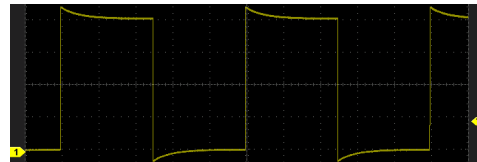

Picture 2-17 Overcompensation

If the waveform on the screen is shown as under-compensation or over-compensation, please adjust the probe until the waveform shown as correct-compensation.

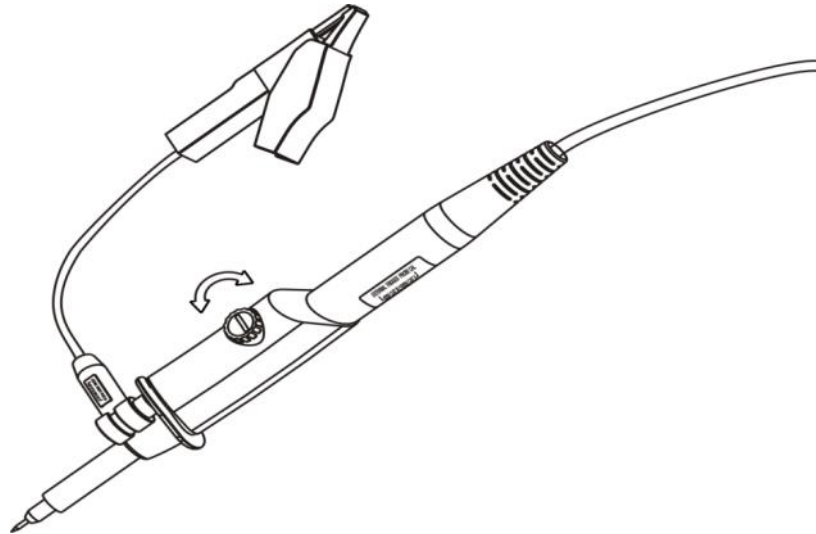

Picture 2-18 Probe adjustment



Warning in any case using the probe should follow these steps

- *Ensure the wire insulation is good to avoid probe electric shock while measuring high voltage;*
- *Keep your fingers behind the probe security circle to prevent electric shock;*
- *Do not touch metal parts of the probe-head to prevent electric shock;*
- *Before the measurement, please correctly connect the probe ground end.*

Chapter Three Use Oscilloscope

This chapter contains the oscilloscope operating details. We recommend you read this chapter carefully, in order to understand abundant functions and specific methods of this instrument.

This chapter mainly includes the following contents

- Channel selection
- Set the channel coupling mode
- Set the channel sampling mode
- Bandwidth selection
- Use delay
- Set channel polarity
- Set probe ratio
- Auto-calibration
- Set auto-measurement type
- Set the save/restore menu
- The cursor measurement
- Set display menu
- Set trigger menu
- Use vertical and horizontal button

- Use auto-set
- Use math menu
- Run/stop button and single sequence
- Reference channel
- Use 50% shortcut button
- Using touch screen zoom waveform

3.1 Channel selection

Current channel: oscilloscope can display multiple waveforms simultaneously, but there is only one waveform can display on the top, which is called the current channel. The current channel arrow is solid, otherwise the arrow is hollow, and the differences are shown in figure 3-1.

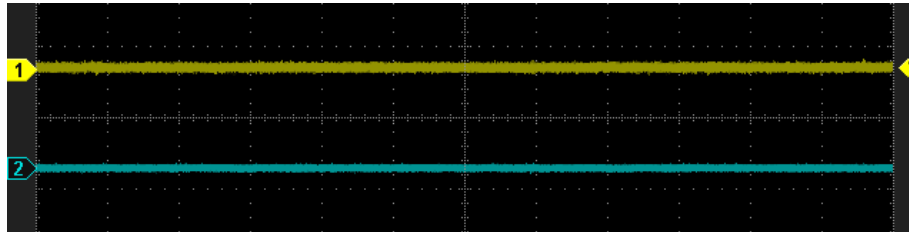

Picture 3-1 The current channel in yellow and the non-current channel in blue

Use buttons: the two buttons  and , corresponding to Ch1 and Ch2 at the front panel

Press on these two buttons can achieve the following three functions respectively

- (a) Open channel (b) Close channel (c) Set the channel as current channel

Taking Ch2 for example



If Ch2 is in open state, but not the current channel, press  to set Ch2 as current channel.

If Ch2 is in current channel state, press  to close Ch2.

If Ch2 is in off state, press  to start Ch2, then the Ch2 is set as the current channel.

Use the touch screen: the left side of the screen is vertical drag and current channel selection area. Press the arrow-pointing channel or press the channel icon under the current channel selection area can set the non-current channel to current channel. But user can't close the channel here.

3.2 Set channel coupling mode

Press  to enter main menu, press  to choose coupling mode as DC, AC or GND, user can operate the steps on touch screen directly.

Set channel coupling mode

Tips: This setting applies only for the current channel, if need setting other channels, user should switch to the current channel first, then press **Ch1** or **Ch2** to switch directly, no need to exit the main menu

Ch1 connects to the DC bias of square wave signal; please follow these steps to set the DC coupling sample

- 1) Press **Scope** to enter main menu set
- 2) Press **F1** to set the coupling mode as DC, waveform is shown in figure 3 -2 DC.

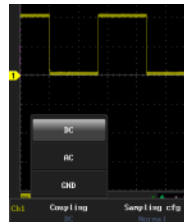

DC

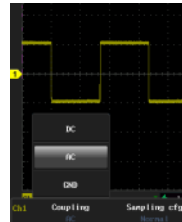

AC

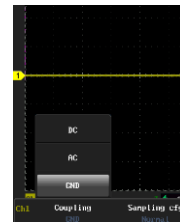

GND

Picture 3-2 coupling

Set channel coupling mode

DC: DC coupling, the measured signal contains the DC and AC components both can get through, as shown in figure 3-2 DC;

AC: AC coupling, the measured signal of DC signals are blocked, only allowing the AC component get through, as shown in figure 3-2 AC;

GND: the measured signal is blocked, as shown in figure 3-2 GND.

Sample coupling mode in the left corner of screen, as shown in picture 3-3, CH1 is in coupling GND, CH2 is in coupling AC, and if there is no arrow point means the channel is in DC coupling.



Picture 3-3 Coupling icon

3.3 Set channel sampling mode

Press **Scope** and **F2** to export sampling cfg menu, then press **F2** and you can choose the sampling config (user can operate the steps on touch screen). The sampling config menu is shown in picture 3-4.

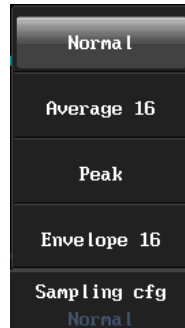

Picture 3-4 Sampling config menu

Systems can support four kinds of sampling configs

1. **Normal** oscilloscope samples signal through equivalent time intervals to build waveform,

the default setting is normal mode. Waveform is shown in picture 3-5.

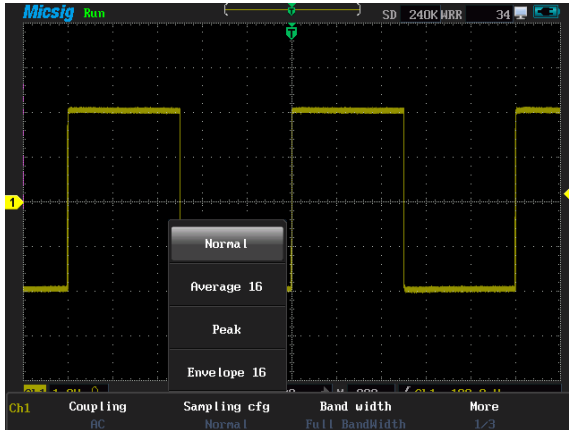

Picture 3-5 Normal sampling config

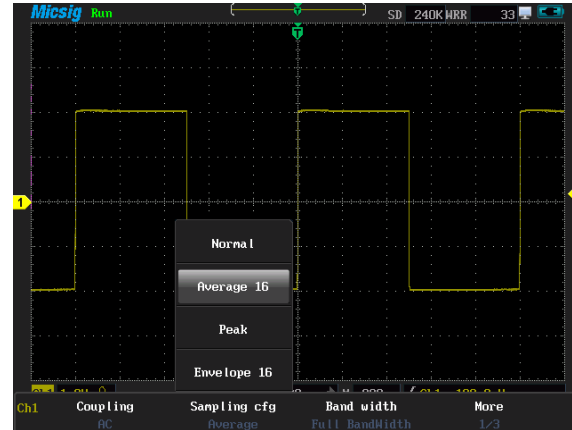

Picture 3-6 Average 16 sampling config



2. Average: waveform does average processing from multiple sampling. You can use the average functions to reject random or uncorrelated noise in the waveform without loss of bandwidth. Press   or roll the wheel to set the waveform average number, selectable average number is 2, 4, 8, 16, 32, 64, 128, 256, and the waveform is shown in

figure 3-6.

3. Peak in this mode, using two continuous capture intervals (include the highest point and the lowest point) can get the possible missing narrow pulses and can be used for burr detection, however, the noise is much higher than normal. See the waveform in picture3-7.



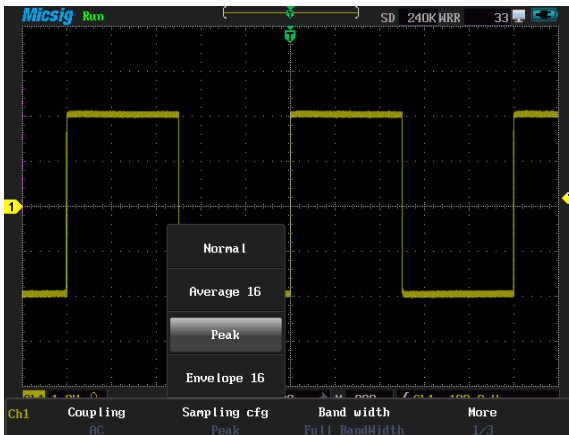
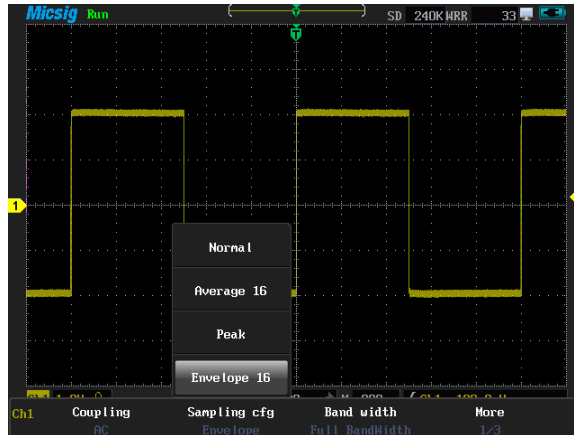

Picture 3-7 peak sampling cfg



Picture 3-8 envelope 16 waveform sampling cfg

4.Envelope: Here you can see the waveform rejection after several samplings. In the specified N samplings, always display the Mini-Max values at the same acquisition positions.

Set channel sampling mode

Press   or roll the wheel to set the number of waveform rejection, which can be set to 2, 4, 8, 16, 32, 64, 128, 256, or infinite, waveform is shown in figure 3-8.

3.4 Bandwidth selection

Press **Scope** and **F3** to set the required bandwidth limit, the 20MHz bandwidth can only keep low frequency component under 20MHz, and high frequency component above 20MHz can attenuation effectively. The difference between full bandwidth and 20MHz can be expressed by waveform. Full bandwidth is shown in picture 3-9; 20MHz bandwidth is shown in picture 3-10.

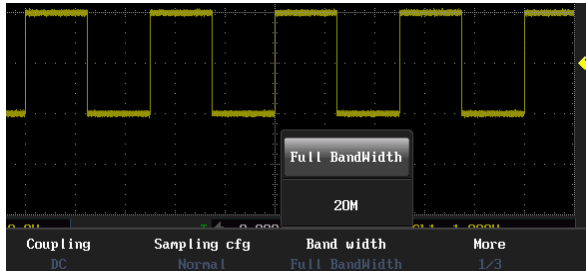

Picture 3-9 Full Bandwidth

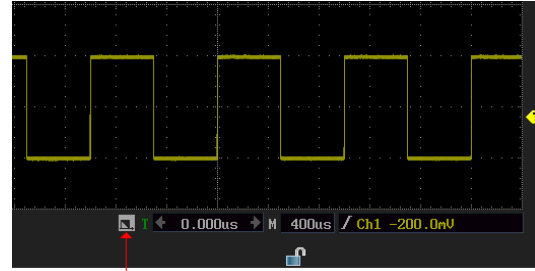

picture 3-10 20 MHz Bandwidth

In picture 3-10, the arrow point indicates bandwidth(20MHz).

3.5 Use delay

Delay is to acquire data later than trigger happened.. When delay is on, the trigger can be removed from the screen, and the horizontal extension point locates in the middle of the screen, and adjusts the horizontal time scale can observe more details of the waveform.

Sometimes the measured value is not stable while measuring pulse width. This is called pulse width jitter. In this case, turn on delay function and extend the time base; and does delayed acquisition after rising trigger to observe the falling waveform jitter. For example,

- 1) Press **Scope** then **F4** then **F1** to choose delay on
- 2) Move the waveform to the left, making the falling edge of waveform in the middle of the screen, as shown in figure 3-11,

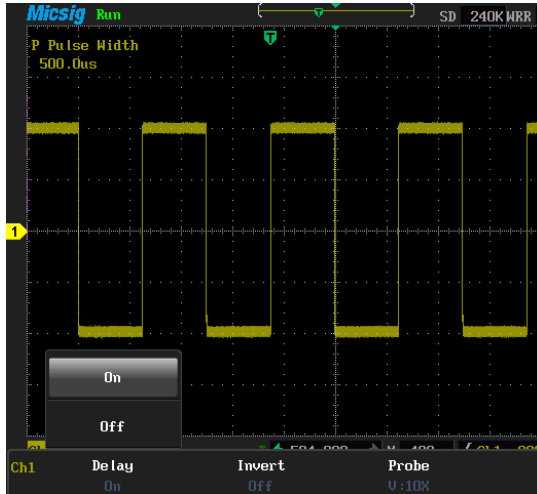

Picture 3-11 On delay menu

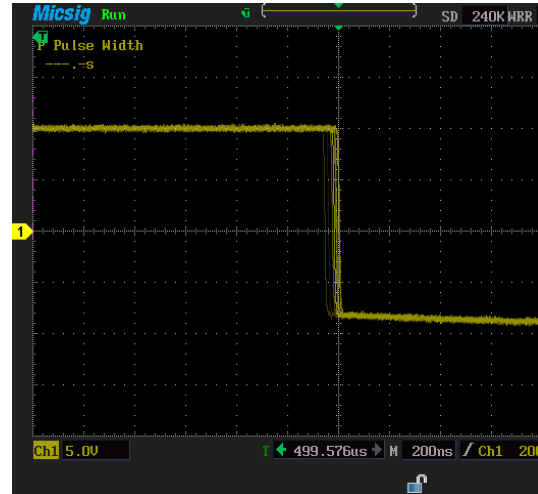

Picture 3-12 Delay state

- 3) Press to enlarge waveform until it jitters significantly, observe the jitter effect shown as 3-12

When delay is on, the trigger readout under the bottom of the screen is time value; when delay is off, the trigger readout is a percentage, the most left side screen is 0%, the most

right side is 100%; two kind of displays as shown in figure 3-13, 3-14.



Picture 3-13 delay **on** and the trigger position



picture 3-14 delay **off** and trigger position

Note: when the delay **on**, adjust the time scale, waveform zoom is based on center of screen. When Delay **off**, adjust the time scale, waveform zoom is based on trigger position

3.6 Set channel polarity

The waveform polarity is relative to the zero level (ground), if the actual signal is positive however in the instrument is negative, which called negative polarity or phase invert. By setting the Ch1 and Ch2 channel's polarity, users can make the two channels work respectively in a phase invert or normal state. Follow the examples to set channel polarity.

Ch1 and Ch2 connected to the same rectangular pulse signal simultaneously and make the Ch1 and Ch2 both **on**

- 1) press **Scope** then **F4** and **F2** ,
- 2) Set Ch1 as current channel, press **F2** to select invert on
- 3) Set Ch2 as current channel, press **F2** to select invert off, waveform is shown in picture 3-15.

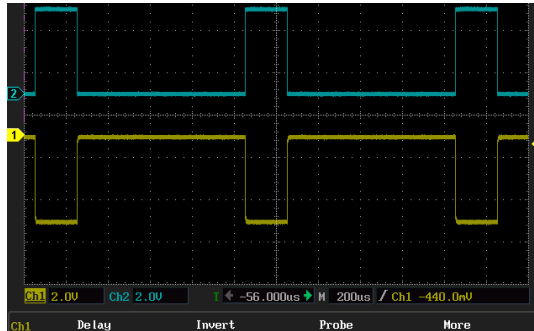

Picture 3-15 Invert polarity of the two waveforms

3.7 Set channel attenuation ratio

To coincide with actual probe attenuation ratio, it is necessary to adjust channel attenuation factor under the channel menu. Such as probe attenuation ratio of 1:1, corresponding input channel attenuation factor set as 1 x.

When probe attenuation factor is changed, users need to enter this menu to set the corresponding attenuation factor, only the set matches, can display waveform's amplitude rightly. Probe attenuation ratios and attenuation factors are shown in the table below,

Probe attenuation ratio	Attenuation ratio menu
1:1	1X
10:1	10X
100:1	100X



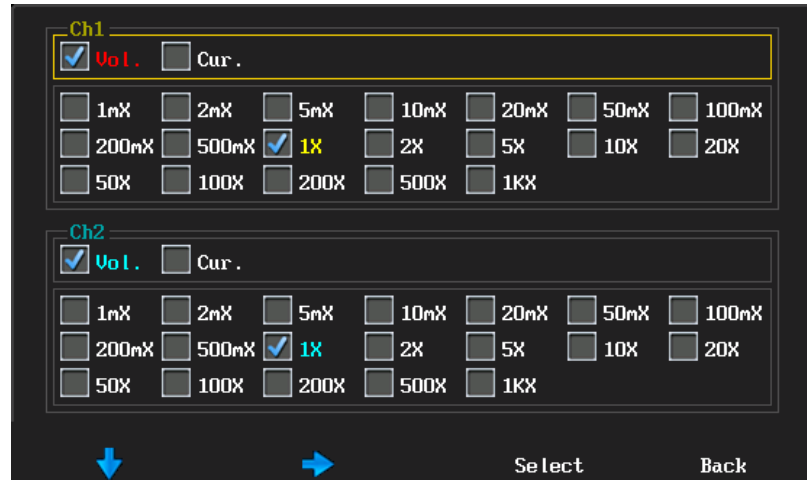

Set channel attenuation factor

Press **Scope** then **F4** then **F3** and **F2** to open channel attenuation factor menu, and set the current channel factor, if need to set another channel, no need to exit, users can switch the current channel to do so, as shown in picture 3-16.



Picture 3-16 Probe attenuation factor menu

3.8 Auto-calibration

According to the current environment, automatically calibrate each channel scale's zero position and parameter. In oscilloscope mode, press  then  then  and  into auto-calibration mode. When auto-calibration function is active, the upper left corner of the screen displays calibrating in red, after calibrating finished, the red calibrating disappear. When the temperature changes largely, auto-calibration can make the instrument maintain high accuracy of measurement

- Auto-calibration should be done without probe
- auto-calibration process takes about two minutes
- if the temperature changes above 10°C, we recommended users perform the auto-calibration

3.9 Set auto measurement type

Press  can open auto-measurement menu and there are 31 kinds of

Set auto measurement type

auto-measurement types applied to Ch1, Ch2, math and reference channel. Before choosing the measurement type, it must set the measured channel as current channel.

The instrument can display four measurements simultaneously. Types and specifications are shown in the table.

Serial	Type	Instructions
1	Period	The time required to complete the first cycle in a waveform or gated region; period is the reciprocal of frequency and is measured in seconds.
2	Rate	Reciprocal period time
3	Rise time	The time required for the leading edge of the first pulse in the waveform or gated region to rise from the low reference value(default=10%)to the high reference value(default=90%)of the final value
4	Fall time	The time required for the falling edge of the first pulse in the waveform or gated region to rise from the low reference value(default=90%)to the high reference value(default=10%)of the final value

Set automatic measurement type

5	P duty cycle	The ratio of the positive pulse width to the signal period expressed as a percentage. the duty cycle is measured on the first cycle in the waveform or gated region
6	N duty cycle	The ratio of the negative pulse width to the signal period expressed as a percentage. the duty cycle is measured on the first cycle in the waveform or gated region
7	Delay	The time between the mid reference(default 50%) amplitude point of two different waveforms
8	P pulse width	The distance between the mid reference(default 50%)amplitude points of a positive pulse. the measurement is made on the first pulse in the waveform or gated region
9	N pulse width	The distance between the mid reference(default 50%)amplitude points of a negative pulse. the measurement is made on the first pulse in the waveform or gated region

Set automatic measurement type

10	Burst width	The duration of a burst(a series of transient events) and is measured over the entire waveform or gated region
11	P overshoot	This is measured over the entire waveform or gated region and is expressed as $P \text{ overshoot} = [(max - high)/amplitude] \times 100\%$
12	N overshoot	This is measured over the entire waveform or gated region and is expressed as $N \text{ overshoot} = [(low - mini)/amplitude] \times 100\%$
13	Phase	The amount of time that one waveform leads or lags another waveform, expressed in degrees where 360° comprises one waveform cycle.
14	Peak-peak	The absolute difference between the max. and min. amplitude in the entire waveform or gated region
15	Amplitude	The high value less the low value measured over the entire waveform or gated region
16	High	The value is used as 100% whenever high reference, it can be calculated using either the min/max or histogram method.
17	Low	The value is used as 0% whenever high reference, it can be calculated using



Set automatic measurement type

		either the min/max or histogram method.
18	Max	Typically the highest positive peak voltage which is measured over the entire waveform or gated region
19	Mini	Typically the lowest negative peak voltage which is measured over the entire waveform or gated region
20	Mean	The arithmetic mean over the entire waveform or gated region
21	Cycle mean	The arithmetic mean over the first cycle in the waveform or the first cycle in the gated region
22	RMS	The true Root Mean Square voltage over the entire waveform or gated region
23	Cycle RMS	The arithmetic mean over the first cycle in the waveform or the first cycle in the gated region



Use button: Use the wheel or touch screen to select measurement types and related settings.

press  to upward cycle, press  to downward cycle, press  to right

Set automatic measurement type

cycle, press   or roll the wheel to left/ right, from top to bottom cycle, press  to confirm or cancel options. Press the touch screen to choose item or cancel this measurement type directly.

Measure Ch1 frequency and Vpp, measure Ch2 rise time, Vmean, please follow these steps.

- 1) Plug probes to Ch1 and Ch2 respectively, and connect them to signal source;
- 2) Set Ch1 as current channel, press  then the screen popup measurement types, press on the touch screen, select Ch1 measurement type as the “Frequency” and peak-peak; press  to choose Ch2 as current channel, and set Ch2 measurement types as rise time and mean
- 3) Adjust the vertical scale and horizontal scale; make the waveform display At least one entire cycle. Picture 3-17

Set auto measurement type

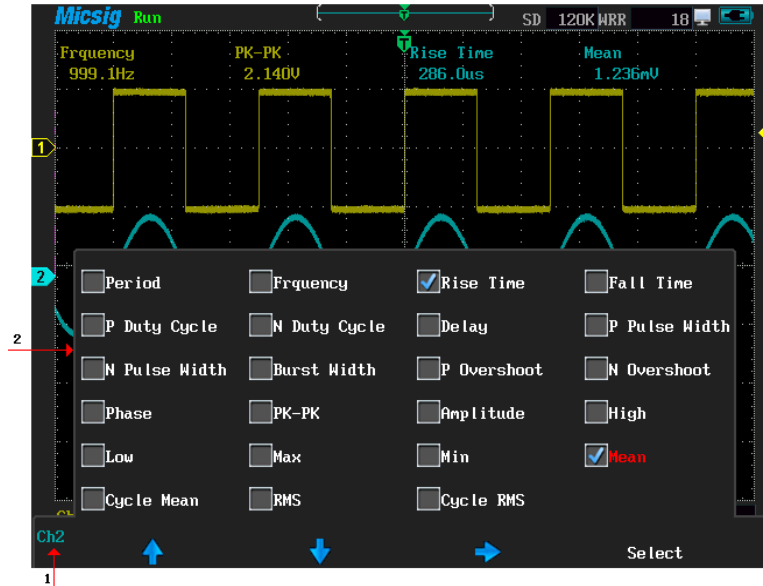

Picture 3-17 Measurement types



Introductions of measurement types on the screen: 1 Current channel

2 Measurement types menu

3.10 Store/ restore menu

On this menu, users can do operations like, save/recall waveform, and adjust the memory depth, dynamic waveform record/playback, save/recall settings, and screen snapshot

3.10.1 Save



Press  and  to enter the save waveform menu, to save Ch1/Ch2/math waveform as reference waveform, which marked in color purple. Date and time displayed under the To Ref R*means this memory has already saved waveforms, blank means no waveform saved. Picture 3-18



Picture 3-18 The reference waveform

Please follow these steps to save Ch1 waveform to R1,

1) Connect probe to Ch1 and connect it to the signal source.

2) Press  and  to enter the save waveform menu.

- 3) Press **F1** to store waveform to R1, shown in picture 3-19, yellow waveform is Ch1 waveform, purple one is the waveform after being saved. The two waveforms overlap with each other.

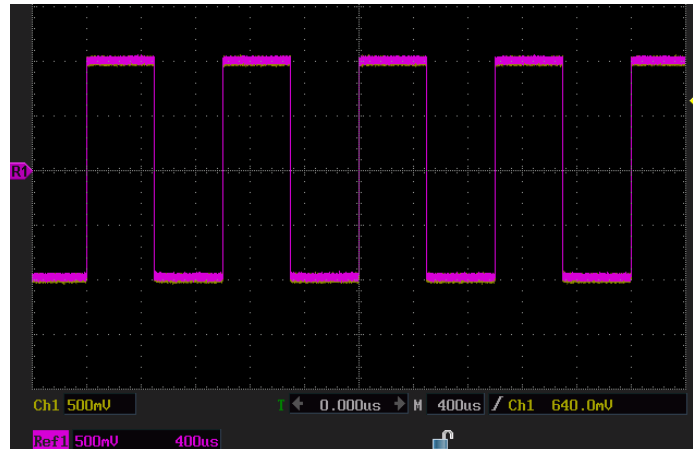



Picture 3-19 Stored waveform to R1







It can save four reference waveforms (R1/ R2/ R3/ R4) at most. If continue repeat saving,

the original waveform will be covered.

3.10.2 Restore

press  and  to enter the waveform recall menu, the recalled waveform is in purple and the instrument can display four recalled waveforms simultaneously if waveform recall menu displays in gray which means no waveform data. If marked “Refer R” illustrates the waveform is selected.

Please follow the steps to recall waveform



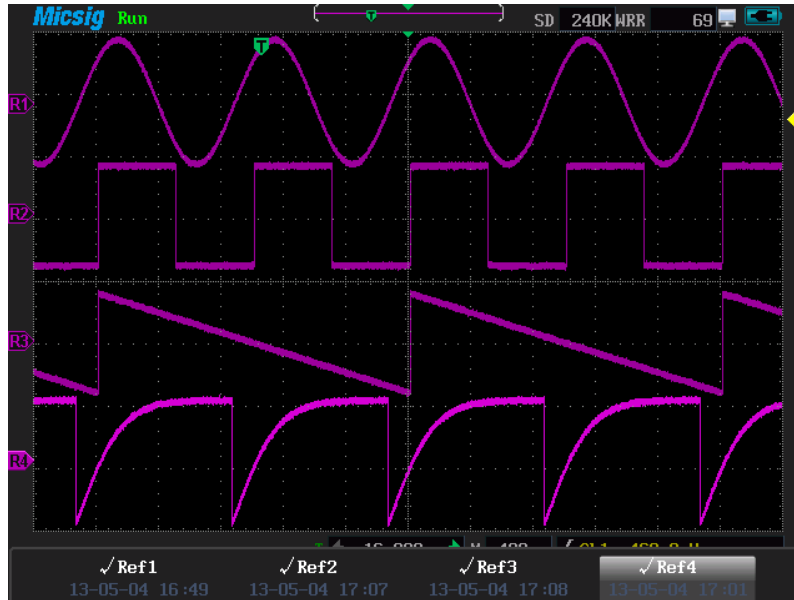

- 1) Press  and  to enter the waveform recall menu;
- 2) Press  to recall waveform Ref1 and then the Ref1 is the current waveform
- 3) Press  then  and  to restore waveforms (R2/R3/ R4), please refer to picture 3-20.



Picture 3-20 restore waveform

3.10.3 Memory depth









Memory depth means the oscilloscope's capacity of storing sample points. For example, the store depth is 120K, and it says it can store 120k sample points.

Press  and  to enter the adjustment menu of store depth, if it is a single channel, it can be set to 2.4K, 24k, 240k, and a dual channel can be set to 1.2k, 12K, 120k, and press   to adjust the value of store depth.

3.10.4 Dynamic record

Dynamic record can easily record the waveform and memory operation steps. Only after identifying the USB storage device can start dynamic record. U device icon will be displayed at upper right corner if U device is connected and 'Dynamic record' turn white (grey previously) (note: system divides U device into four store area automatically, based on the need to store the four different information into separate areas. if the record area has stored waveform, the record will overlap the last record)

● **Waveform record**

Press  then  then  and  to enter the waveform record menu, then press  then  then  or  to select the corresponding store area and start waveform record, as shown in picture 3-21.

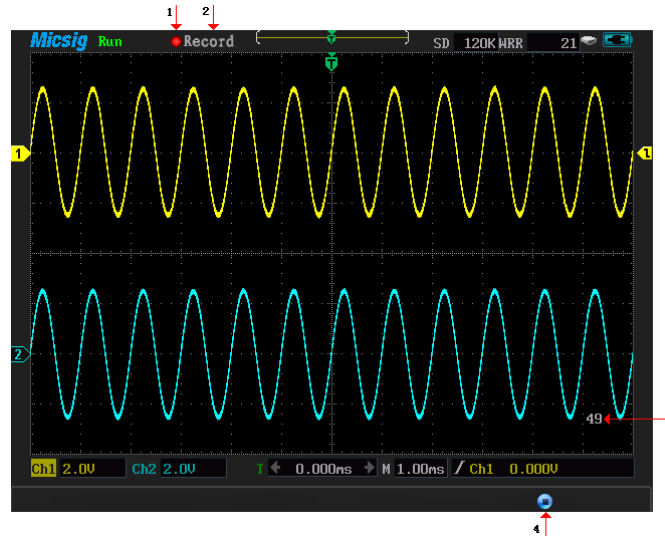

Picture 3-21 Waveform record

Interface descriptions of waveform record





1. Recording ● icon, the icon flashes while recording
2. Dynamic record mode, being record

3. Frame number for the current record

4. Stop , press  to record waveform and return to the previous menu

● Playback waveform data





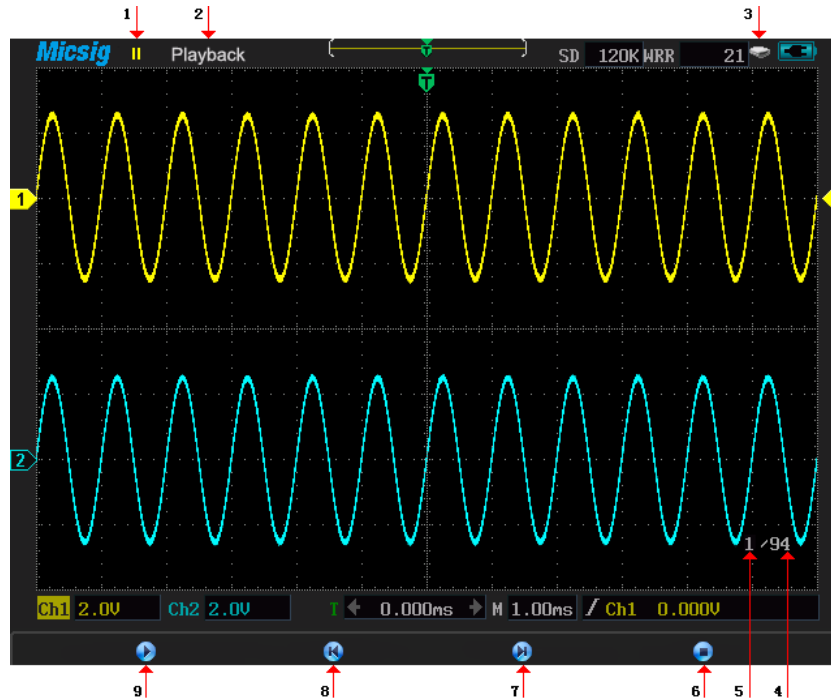





Press  then  then  and  to enter the waveform playback menu;

Then press  then  then  or  to select corresponding store area and press  to start the waveform playback. See picture 3-22.



Picture 3-22 waveform data playback

Interface descriptions of waveform playback





1. Run , timeout , stop , the current state is running.
2. Dynamic record mode, being playback mode
3. External USB storage device icon
4. Total frames
5. Current playback frame number
6. Stop , press  to stop waveform playback and return to the previous menu
7. Forward 
8. Back 
9. Play  stop , press  to operation

Tips: Press  can speed forward or backward, each press can forward/back10 frames, and long pressing this button means quick forward/backward



3.10.5 Store settings

To store current setting, press  then  and  to enter store settings menu, press the function menu to select one store slot(Up to 9 storage slots is available).

3.10.6 Restore settings

Restoring a setting from this instrument, users should press  then  and  to restore settings menu, press  to restore the default setting. Details of restore settings are shown as appendix C. Choose other menu item can restore corresponding saved setting.





3.10.7 Screen snapshot







After identifying the U device, the menu color of the “screen shot” changes from grey to white, then the screen shot function is active. Screen shot will format the current screen to BMP image and save it to U device. Press  then  and  to complete screen shot

3.11 Cursor measurement

Press  to enter cursor menu. There are vertical and horizontal cursors, horizontal cursor measures vertical direction value, and vertical cursor can measure both horizontal and vertical direction values. Using the horizontal cursor and vertical cursor to open cursor, close the cursor and switch the horizontal or vertical cursor.

Take the vertical cursor for example

- When the vertical cursor is off, press “vertical cursor”, correspondingly press  to open vertical cursor. Then vertical cursor is current cursor. Which is marked as .
- When the vertical cursor is open, but not the current cursor, then press  to set the vertical cursor as the current cursor.
- If vertical cursor is the current cursor, then press  to shut down vertical cursor.

Instructions about activate/move the cursor: press  to open the cursor menu and select the current cursor, then press  to activate the cursor(activated cursor is in solid line and others as hidden line), press   or roll the wheel to move the active cursor; press  to open the tracking mode and activate the two cursor simultaneously, then press   or roll the wheel to move the two cursors simultaneously. The results are shown in the upper-right of the screen. See picture 3-23.

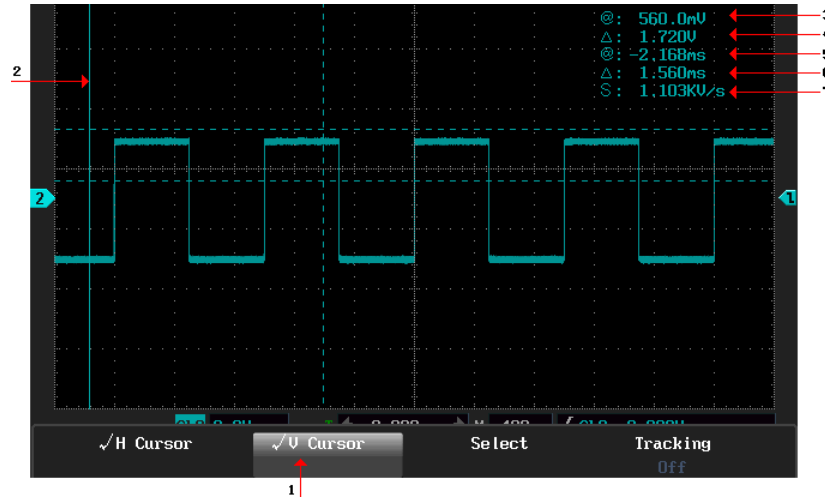

Picture 3-23 H Cursor and V Cursor

Interface descriptions of horizontal and vertical cursor

1: Current cursor

2: Activated cursor

3 @: (1)when only horizontal cursor is opened, it indicates the activated horizontal cursor is

relative to the voltage difference value which is at the zero level.

(2) When only open vertical cursor, it indicates the activated vertical cursor and the waveform intersection point are relative to the zero level of voltage difference value.





(3) When horizontal and vertical cursor are opened simultaneously, it indicates the last activated horizontal cursor is relative to the zero level of voltage difference value.

4 Δ : (1) when horizontal cursor is opened, it indicates voltage difference value between two horizontal cursors (2) when vertical cursor opened alone, it indicates the voltage difference value between two vertical cursors and waveform intersection point.

5 @: The last activated vertical cursor is relative to the time difference value of the trigger point

6 Δ : Time different value between two vertical cursors

7 S: equal to horizontal cursor Δ (voltage difference) / the vertical cursor (time difference), that is the slope of the four cursors intersection

Instructions of the cursor or trigger level switch operation: After opening the cursor menu, press  to close the menu, the bottom right corner of the screen displays Level and Cursor, then press  or press the touch screen to switch. When the Level is active, press   or roll the wheel can adjust trigger level, see picture 3-24, while the Cursor is lighted on, the operator is the cursor, see picture 3-25.

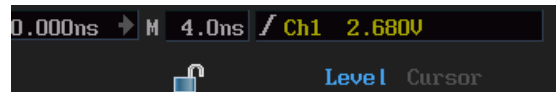

Picture 3-24 Trigger level operation



Picture 3-25 Operate the cursor

3.12 Set display menu

In this menu, you can set waveform as Draw Type, Brightness, Graticule, and Graticule Intensity, Persist , Time base and Refresh Rate



3.12.1 Waveform settings

Set waveform draw type mode and waveform brightness. Waveform display mode shows as sampling dots and vectors, the waveform brightness displays in percentage. See picture 3-26



Picture 3-26 Waveform set menu

a) Following the below steps to set waveform as sampling dots.

- 1) Press  to enter the display menu;
- 2) Press  to enter waveform setting;
- 3) Press  to enter draw type set;

- 4) Press **F1** to choose skeleton pattern as Dots. See picture 3-27.

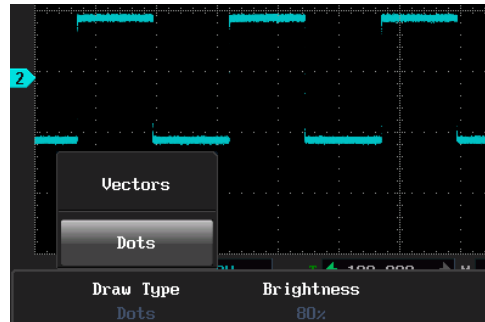

Picture 3-27 point display

b) Following the below steps to set waveform brightness

- 1) Press **Display** **F1** **F2** to choose brightness set
- 2) Press **△** **▽** or roll the wheel to adjust the waveform brightness.

3.12.2 Graticule set







To set the graticule type and intensity, the type includes full, grid, cross hair and frame.

Graticule set menu as shown in picture 3-28



Picture 3-28 Graticule set menu

Following the below steps to set graticule

- 1) press  and  to enter “graticule” setting
- 2) press  to set graticule type, view picture 3-29 and the frame type shows the border
- 3) Press  and select the graticule intensity and then press   or roll the wheel to adjust graticule intensity.

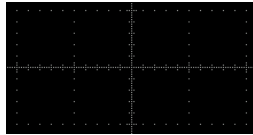

Full

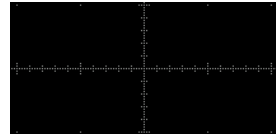

Crossing line







Grid

Picture 3-29 Graticule type



3.12.3 Persist adjustment

Active persist to delay waveform illumination's attenuation, the Time can be set as 100ms-10s, ∞ , or auto. Keep all the waveform illumination spots, until toggle the control setting to remove persist display.

Tips for adjusting afterglow time: Singly press  or  for precise adjustment and long press  or  for rough adjustment

Following these steps for persistence settings

- 1) Press   to enter persist set;

2) Press **F1** to persistence set and press   or roll track-wheel to adjust the persistence time; press **F2** to auto persist; Press **F3** to erase persist.

Persist time is ∞ shown in picture 3-30, persist time is 200ms shown in picture 3-31.

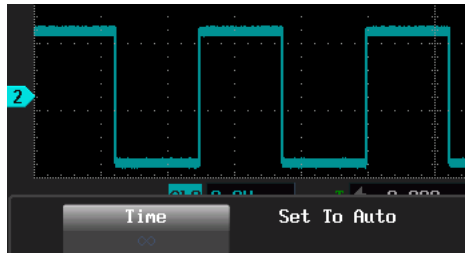

Picture 3-30 persist time ∞

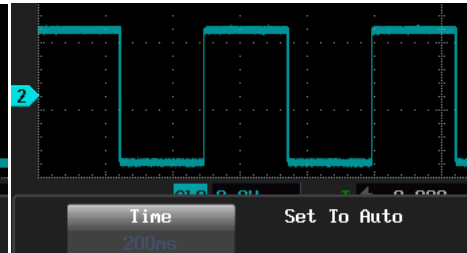

picture 3-31 persist time 200ms



3.12.4 Time base

In the Time base menu, you can set the waveform display as YT or XY mode. YT model shows the relative relationships between vertical voltage and horizontal time; if XY mode, horizontal axis shows as Ch1 and vertical axis shows as Ch2.

1) The following functions are invalid in XY display:

- Reference& math waveform
- Cursor
- Trigger control
- Auto (Waveform display mode switch to YT mode automatically)

2) Following the steps to choose time base:

- Press  to enter display menu;
- Press  and  to select time base as XY, waveform is shown in picture 3-32.



Picture 3-32 XY timescale

3.12.5 Adjusting refresh rate

High refresh rate of the oscilloscope will provide more signal character, and can greatly increase the probability of the oscilloscope to capture instantaneous abnormality, such as jitter, stunt pulse, low frequency disturbance and instantaneous error.

Please follow the steps for setting refresh rate

Press **Display** then **F4** and **F2** to adjust the refresh rate, high refresh, and normal refresh which are shown in picture 3-33.

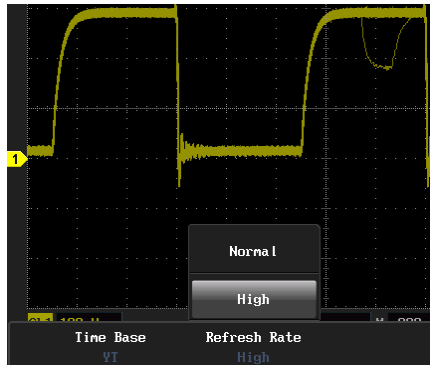

High refresh rate

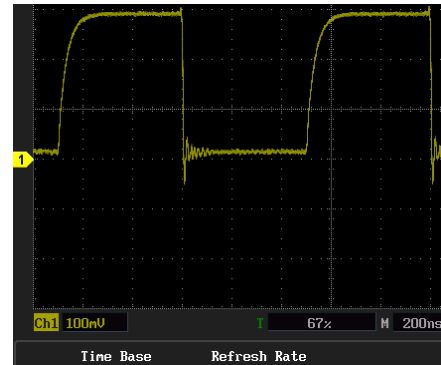

Normal refresh rate

Picture 3-33 Refresh rate



3.13 Set trigger menu

Press **Trigger** and **F1** to enter the trigger type choice menu, there are five kinds of

trigger types available

1. Edge trigger: When the edge trigger signal reaches a certain given trigger level, then trigger happens.
2. Pulse width trigger: When signal of the pulse width reaches a certain given trigger condition and the signal voltage reaches the given trigger level, then trigger happens.
3. Logic trigger: When two channel levels meet a certain logic operation result, then trigger happens.
4. Video trigger: Trigger for PAL, NTSC, SECAM, 720P, 1080I, 1080P
5. Serial bus trigger: Serial decode and trigger for UART (RS232/RS422/RS485) /SPI/I2C/CAN/LIN.

Trigger level: Trigger level is the signal's voltage value which trigger event occurs, shown as

. press  or roll the wheel to adjust trigger level, the screen will temporarily display a horizontal line to show the level position. See the trigger level at picture3-34(arrow shows the trigger level is horizontal line).

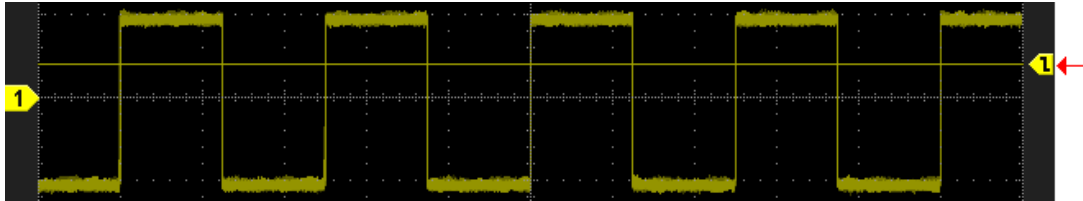

Picture 3-34 trigger level

Trigger coupling mode:

DC	Let signal pass through AC and DC components
AC	Filter DC component from trigger signal
HF rejection	Reject the trigger signal which is higher than 35Khz
LF rejection	Reject trigger signal which is below 90KHz
Noise rejection	Reject high-frequency noise from trigger signal

Trigger mode:

Auto	No matter whether meet the trigger condition waveform displays. In a period if the instrument cannot reach the trigger condition, it can trigger automatically.
Normal	Only display When effective trigger event happens.
Single sequence	Trigger only signal time.

Trigger hold-off time: Rejection time refers to the hold time of oscilloscope retrigger. Before the end of the rejection, the oscilloscope won't trigger. Correctly set hold time can make complex waveform trigger stable (e.g., pulse series). The trigger hold time can be set to 200 ns - 10 s.



3.13.1 Edge trigger











When the signal meet the given edge trigger condition, and signal voltage reaches the

given trigger level, then trigger happens. Edge trigger menu descriptions are shown as below table.

Trigger	Set	Descriptions
Trigger Source	Ch1	Set Ch1 as source trigger
	Ch2	set Ch2 as source trigger
	EXT	Set external signal as trigger signal source
slope	/	Set trigger on rising edge “/”
	\	Set the signal trigger \
	Dual edge	Set the signal in the rising and falling edge trigger





Set trigger on Ch2's rising edge, trigger mode as auto and trigger coupling as DC, refer to the following steps:

- 1) press  and  to select the trigger type as edge
- 2) press  to select source signal as Ch 2

- 3) press  to set slope is “/”(rising edge), press   or roll the wheel to adjust the trigger level.
- 4) press   to select coupling mode as DC;
- 5) Press  to select trigger mode as normal;
- 6) Press  and  to set the hold-off time and press   or roll the wheel to adjust time, rise trigger(/) waveform is shown in picture 3-35.











Picture 3-35 The rise (/) waveform



Tips for adjusting rejection time: Singly press  or  for precise adjustment; Long press  or  to rough adjustment.

EXT trigger refers to the external source as a trigger source; The external signal source can

be square waveform, sine waveform etc. Using external trigger, users should firstly connect the multimeter jack to signal source, then set trigger condition and trigger level according to the proper value of the signal source.

Connect Ch1 to sine waveform, select external trigger, connect the signal source to square waveform (2.0V), select trigger condition as rising edge (/) and trigger level as 1.78V. Please follow these steps

- 1) press  and  to select trigger mode as edge trigger;
- 2) press  to select source as EXT;
- 3) press  to select slope as rise edge (/) and press   or roll the wheel to adjust trigger level to 1.78V;
- 4) press  and  to select coupling mode as DC;
- 5) press  to select the trigger mode as normal;

6) press **F4** and **F2** to select “rejection time” and press   or roll the wheel to adjust rejection time. The waveform is shown as picture 3-36.

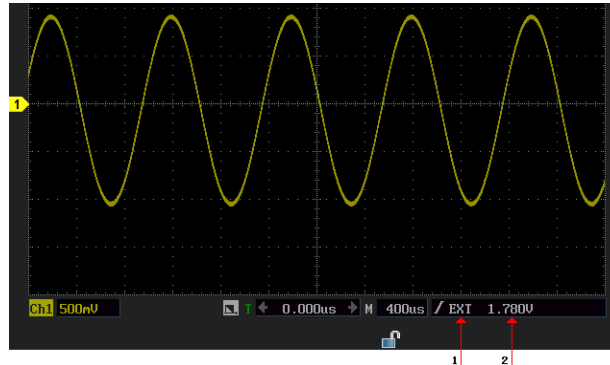

Picture 3-36 (EXT) trigger waveform















3.13.2 Pulse width trigger

When the trigger signal pulse width is 40 ns - 10 (s) and reaches the given condition and if the signal voltage reaches the trigger level, then trigger happens. Pulse width menu is shown in the table below:

Trigger configure item	Options	Descriptions
Trigger source	Ch1	Set the Ch1 as trigger signal source
	Ch2	Set the Ch 2 as trigger signal source
	EXT	Set external signal as trigger signal source
Polarity	Positive	Set signal as positive polarity pulse width trigger
	Negative	Set signal as negative polarity pulse width trigger
Conditions	< T	Trigger if the pulse width is less than T
	> T	Trigger if the pulse width is more than T
	= T	Trigger if the pulse width equals to T
	≠T	Trigger if the pulse width not equals to T

Notes: conditions of = or ≠, indicating that the floating range is 5%

Connect Ch2 to square waveform(amplitude=2.0V, frequency=2KHz), trigger type as the pulse width, conditions as≠1.0ms, trigger level as 0V, follow the steps as below:

- 1) Press  and  to select the trigger type as pulse width
- 2) Press  to select trigger source as Ch2;
- 3) Press  to select the polarity as positive;
- 4) Press   to roll the wheel as the trigger level to 0V.
- 5) Press  and  to select trigger condition as “≠” and press   or roll wheel to adjust time as 1.0ms;
- 6) Press  to select trigger mode as normal
- 7) Press  and  to select rejection time and press   or roll the wheel to adjust rejection time, positive polarity pulse width trigger waveform is shown in picture 3-37.

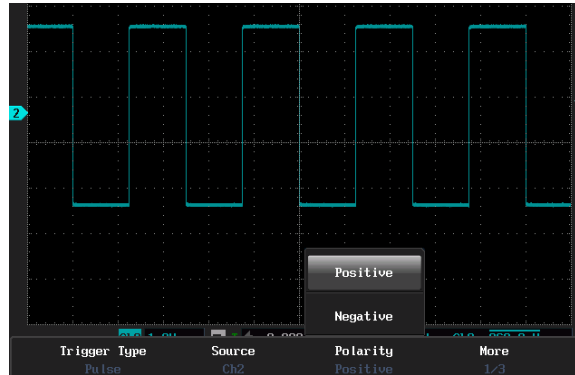

Picture 3-37 Positive polarity pulse width trigger

















3.13.3 Logic trigger

According to the given trigger level, firstly convert the two channels' sample values into logic value. If reaching the trigger condition, trigger happens. Logic trigger menu's descriptions are shown in the table.

Trigger config items	Options		Descriptions
Trigger source	Ch1 logic	Low	If Ch1 lower than trigger level, set Ch1 as 1
		High	If Ch1 higher than trigger level, set Ch1 as1
	Ch2 logic	Low	If Ch2 lower than trigger level, set Ch2 as 1
		High	If Ch2 higher than trigger level, set Ch2 as1
Logic operator	AND		The logic of two trigger sources as AND
	OR		The logic of two trigger sources as OR
	NAND		The logic of two trigger sources as “NAND”
	NOR		The logic of two trigger sources as “NOR”
Conditions	Change to true value		Trigger if the logic changes to true value
	Change to false value		Trigger if the logic changes to false value
	>,<,\neq,T		If logic status for hold time as>,<,\neq , then trigger

If Ch1 logic as “high”, Ch2 logic as “low”, AND then trigger, follow the steps as below,

- 1) press   to select logic trigger

- 2) Press  to set Ch1 as logic high
- 3) Press  to enter Ch1 logic level setting mode, then press   or roll the wheel to adjust
- 4) Press  and  to set Ch2 logic low
- 5) Press  to set Ch2 logic level, press   or roll the wheel for adjustment
- 6) Press  and  to set logic operator as AND
- 7) Press  to set trigger condition as true-value
- 8) Press  and  to select trigger mode as normal
- 9) Press  to select rejection time, then press   or roll the wheel to

adjust rejection time. Trigger logic waveform is shown in picture 3-38.

1. Logic trigger operation mode
2. Ch1 logic trigger level, the readout under the upper line means CH1 logic as high.
3. Ch2 logic trigger level, the readout above the underline means CH2 logic as low.

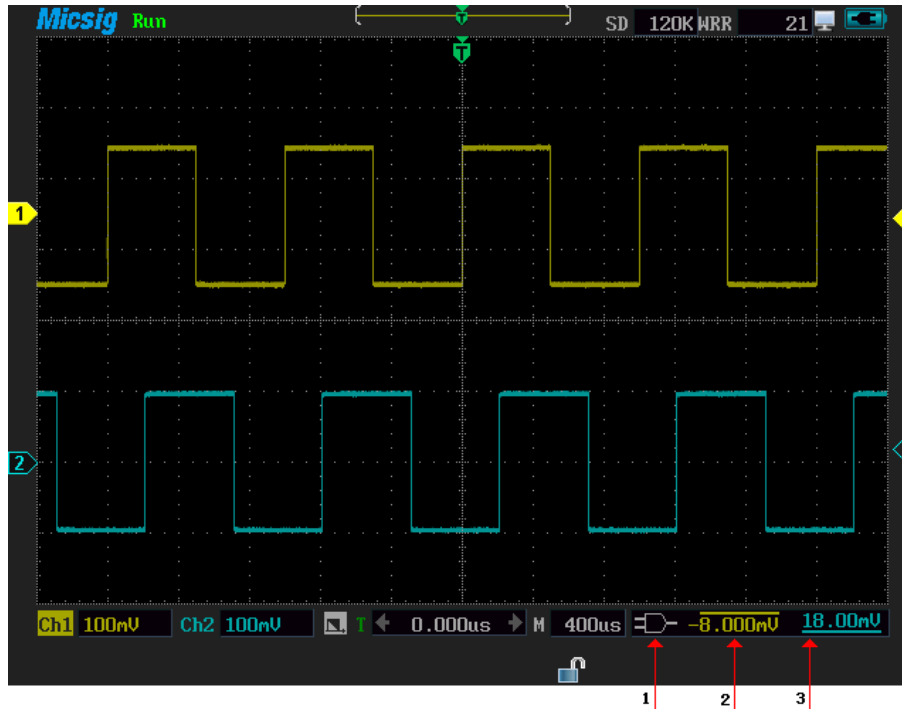

Picture 3-38 Logic trigger

3.13.4 Video trigger

Triggering on video signal field or line supports PAL, SECAM, NTSC, 720P, or 1080P standard. It can trigger on different voltage scale, and users can adjust voltage gear to view waveform.







Video trigger menu descriptions are shown in the table below:

Trigger selections	Setting	Descriptions
Trigger source	Ch1	Set Ch1 as trigger signal source
	Ch2	Set Ch2 as trigger signal source
Polarity	Positive	Set signal positive polarity trigger
	Negative	Set signal negative polarity trigger
Standard	625/PAL	Base on PAL standard
	SECAM	Base on SECAM signal trigger
	525/NTSC	Base on NTSC signal trigger
	720P (50Hz, 60Hz)	Base on 720P(50Hz, 60Hz) signal trigger
	1080I (50Hz, 60Hz)	Base on 1080I (50Hz, 60Hz) signal trigger
	1080P (24Hz, 25Hz)	Base on 1080P (24Hz, 25Hz, 30Hz, 50Hz, 60Hz) signal

	30Hz, 50Hz, 60Hz)	trigger
Trigger on	Odd fields	Interlaced scanning signal trigger in odd fields
	Even fields	Interlaced scanning signal triggered in even fields
	All fields	Interlaced or non-interlaced scanning signal trigger in any fields
	All lines	Trigger on line of signal.
	Line	Signal trigger in a specified line

Ch2, positive polarity, video standard PAL, odd trigger, follow steps as below:

- 1) Press **Trigger** and **F1** to select trigger type as video trigger;
- 2) Press **F2** to select signal source as Ch2;
- 3) Press **F3** to select polarity as positive;
- 4) Press **F4** and **F2** to select video standard as 625/PAL;

- 5) Press  to select trigger **on** as odd fields;
- 6) Press  and  to select trigger mode as “ abnormal”
- 7) Press  to select rejection time, press   or roll the wheel to adjust rejection time; Video standard PAL odd fields trigger is shown in 3-39.

Picture 3-39 arrow descriptions:

- 1. Video standard, upper-line means positive trigger, and under-line means negative trigger.
- 2. Indicating trigger condition mode

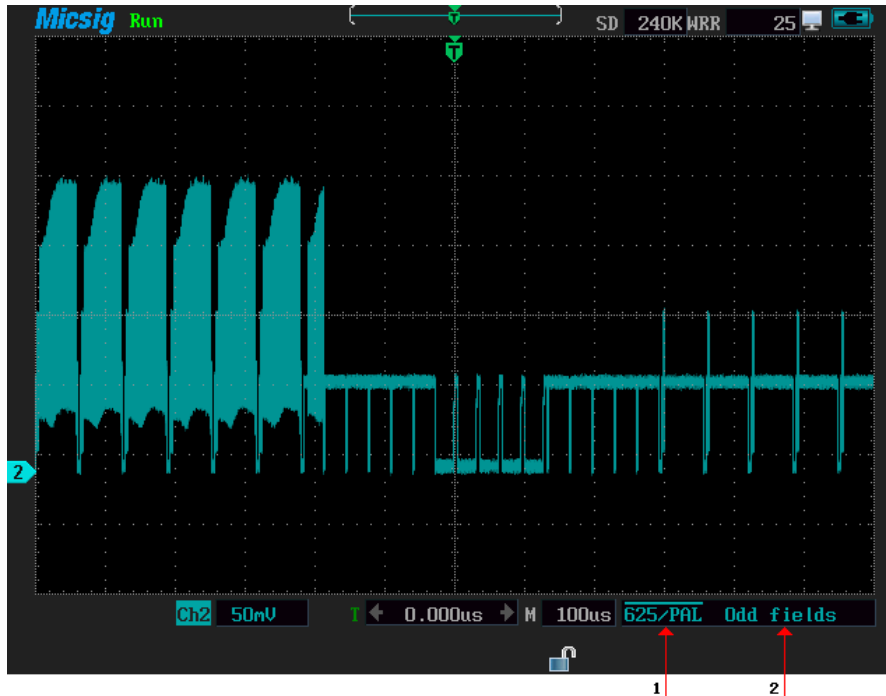

Picture 3-39 Standard PAL odd fields trigger

3.13.5 Serial bus trigger

Refer to **Chapter Four Serial Bus Trigger and Decode.**

3.14 Using the vertical and horizontal button

1. Vertical button

Vertical scale adjustment : it can adjust vertical scale factor for all channels' waveform.

Press  to adjust the vertical scale factor of the current channel, display the waveform on the screen properly. The range of 1:1 probe vertical scale factor is 5 mv/div - 50 v/div and the range of 1:10 probe vertical scale factor is 50 mv/div -500 v/div, step by step of the way 1-2-5.

Vertical button : Adjust all vertical channel waveforms. Each pressing, the waveform of

current channel will move one pixel; long press can make waveform position quick move.

before using the wheel to move waveform, users need to press the vertical  button, and then roll the wheel to up and down waveform.

2. Horizontal button



Horizontal button : simultaneously adjust the horizontal scale of all channels (horizontal time scale). Horizontal time scale is 4ns/div-10s/div, step by step of the way 1-2-4.

When horizontal time scale is greater than or equals to 100 ms, enter the roll mode, which is commonly used to observe waveform less than 2 Hz the roll mode is shown in picture 3-40. (The left upper corner of the screen shows the rolling screen; arrow points the time scale is 100 ms).

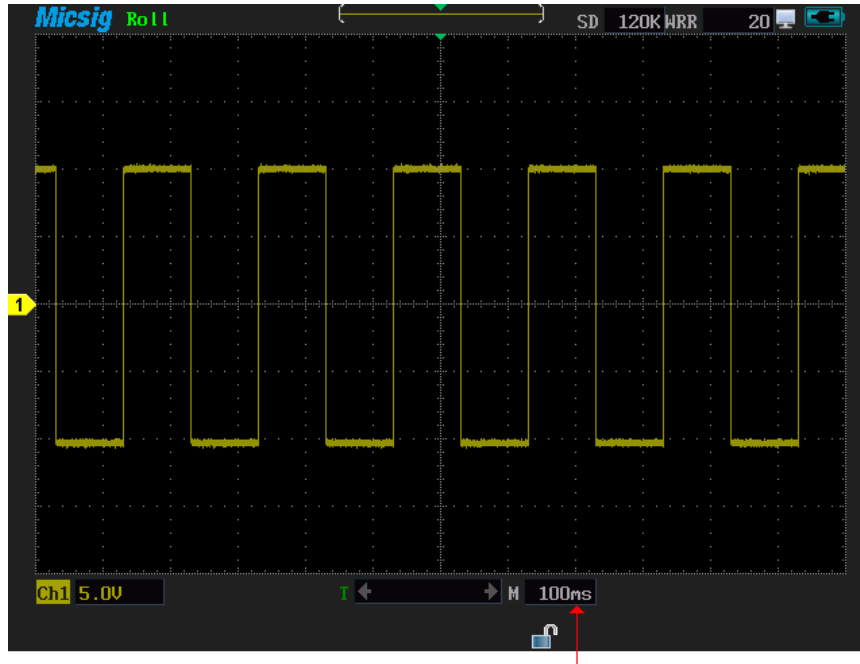
Use vertical and horizontal button



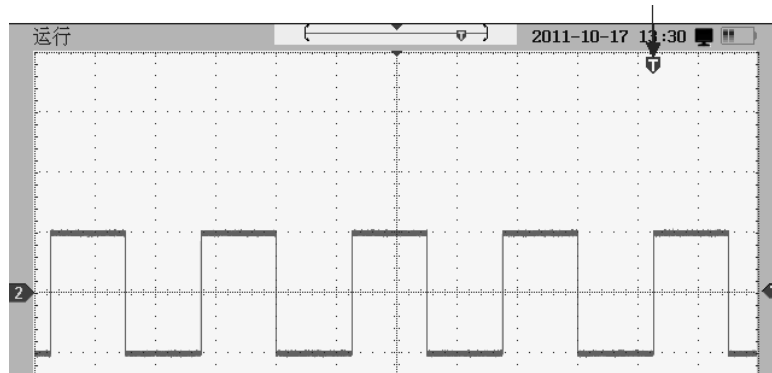

Picture 3-40 Roll mode

Horizontal button : Adjust all channels' horizontal positions, with each pressing, the waveform move one pixel and long pressing can make the waveform quick move.  on the screen is trigger position, if left/right move the waveform, the  position move left/right for user's needs. The waveform moves to right is shown in picture 3-41(arrow points trigger position).



Picture 3-41 waveform moves rightward

3.15 Use auto set

Pressing  and the instrument can automatically adjust the settings of vertical, horizontal scale and trigger to make waveform display properly. And it suits for single channel and multiple channels as well. Pressing , at the upper left corner of the screen appears auto icon, indicates the instrument is in auto mode, re-pressing  to exit auto mode.

In auto mode:

- According to signal amplitude , the instrument can adjust the vertical scale automatically
- According to signal frequency, adjust horizontal time scale automatically
- According to signal amplitude, adjust trigger level automatically
- Manually adjust vertical scale factor, time base and the trigger level. Then auto mode will turn manual mode.



Auto set function changes the instrument by the following ways:

- Sampling mode as normal
- The bandwidth limit sets to full bandwidth
- Invert off
- Delay on
- Trigger type as edge trigger
- Slope as rise (/)
- Trigger as DC coupling mode
- Trigger mode as auto
- Hold-off time as 200ns

3.16 Use math menu

1. Function of Math dual waveform calculation



Press  to open or close math waveform and set math waveform as current waveform.

Press  and  to set the channel as dual waveform calculation, signal source can be Ch1 or Ch2, math operation is shown in the following two waveforms.

Operator	Operation mode
+	Source1 + Source2
-	Source1 - Source2
*	Source1 * Source2
/	Source1 / Source2

Notes: While math waveform displaying on the screen, make sure the waveform will not extend out of the top or bottom waveform window, if some waveforms are out of screen, the math waveform operation results may not be correct.

Math waveform Ch1 + Ch2, follow the below steps,

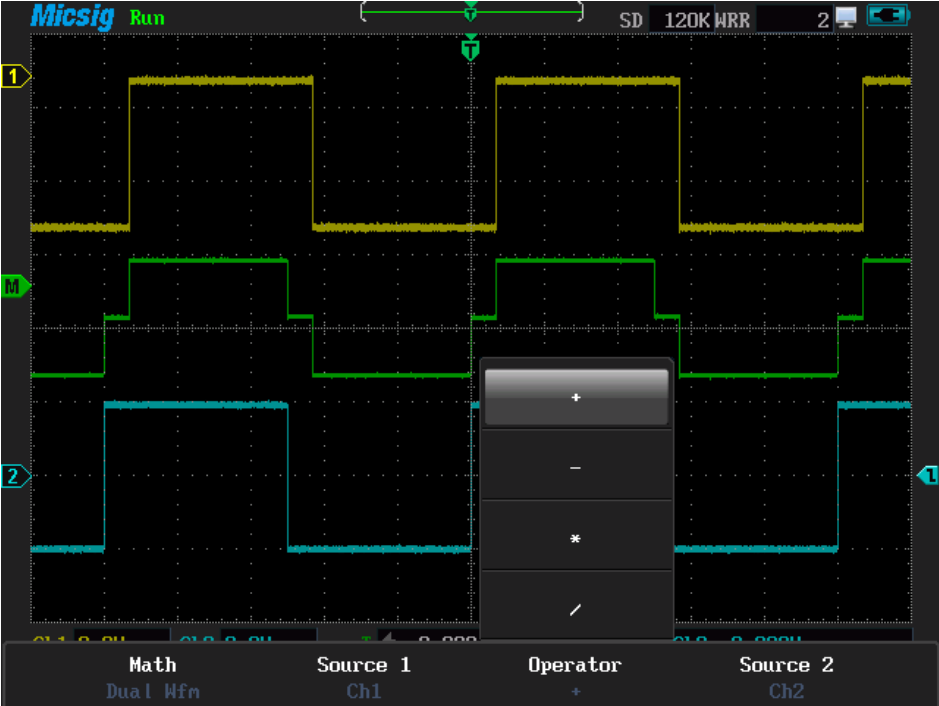

- 1) Press  to enter math menu;
- 2) Press  to select signal source as“Ch1”;

- 3) Press **F3** to select function as“+”;
- 4) Press **F4** to select signal source as “Ch2”; Then view the math waveform operation is shown in picture 3-42.



Picture 3-42 Ch1 + Ch2 math function

2. Use math function of FFT

Successively press  and  to set math as FFT operation. Set Ch1 and Ch2 as signal source, by using the FFT operation; transform the waveform from time-domain to frequency-domain for waveform spectrum analysis. To reduce the effect of side-lobes (leakage), it is recommended to use auto-window; This will automatically adapt the waveform part that is analyzed to a complete number of cycles.

Select rectangular, hanning, hamming or blackmanharris window and ensure the entire waveform amplitude remains on the screen.

Rectangular window:

Trait: best analysis for frequency resolution, but not for amplitude resolution. It is recommended to measure transient or narrow pulse, composite sine waves which amplitude are almost equal and their frequency are very close, or relatively slow changed bandwidth random noise spectrum. As shown in picture 3-34.

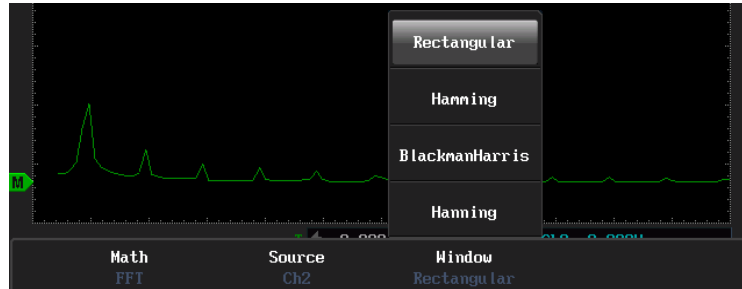

Picture 3-43 FFT windowing

Hanning, hamming window:

Better analysis for frequency rate, not for amplitude rate. Hamming window frequency rate is better than hanning window. It is recommended to measure sine, cycle and narrow band random noise.

BlackmanHarris window:

Best analysis for amplitude rate, but not for frequency rate. It is recommended to measure single frequency signal, look for higher harmonics.

3.17 Run/ stop button and single sequence

1. Run/stop button

Press  and switch oscilloscope's working state between stop and run. In stop state, the last waveform still displays on the screen. Stop state is shown in picture3-44 (the top left corner shows a stop sign), run state is shown in picture3-45(the top left corner shows run).

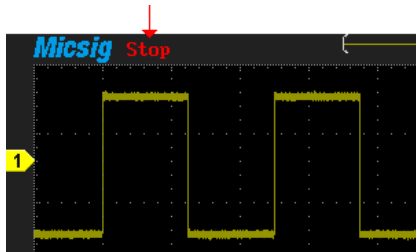

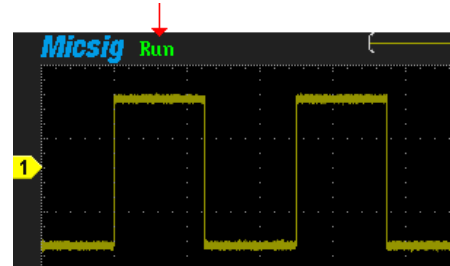

Picture 3-44 stop



picture 3-45 run

2. Use single sequence to observe waveform

Press , and the signal is triggered after reaching the trigger condition and capture the waveform on the screen. Before triggering, the left upper corner of the screen display as wait trigger shown as picture 3-46; After triggering, display stop, shown as 3-47. Repress  to enter a state of continuous sampling.

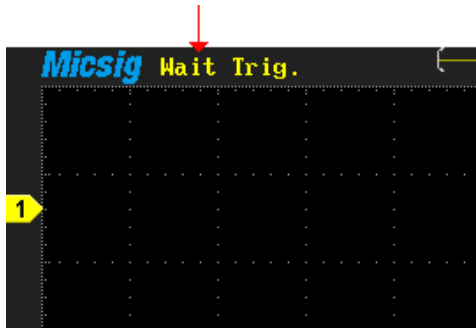

Picture 3-46 Wait trigger

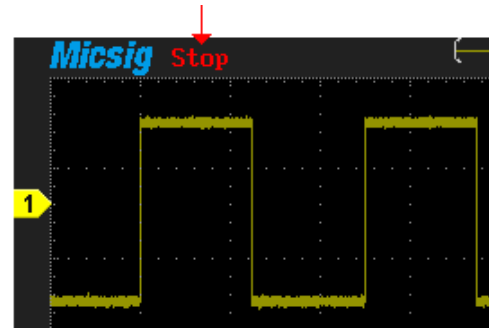

picture 3-47 After trigger



3.18 Reference channel









Press  to open and close reference waveform, and set the reference waveform as the current waveform. After restoring, the reference waveform can zoom, move or measure etc.

3.19 Use 50% shortcut

Use  to adjust the trigger level, vertical position, trigger position, vertical cursor, horizontal cursor quickly.

1. Quickly adjust the trigger level to the center of the trigger source of waveform amplitude:

press  or , then press , The trigger level will automatically set in the center of the waveform

2. Quickly adjust the vertical position to the middle of the screen: Press  then press  to adjust zero level position of the current channel to the screen center.
3. Quickly adjust the trigger position to the middle of the screen: Press  then  to adjust the current channel's trigger position to the center of the screen.
4. In Y-axis, quickly adjust the vertical cursors at left/right half screen to the middle: press  to choose vertical cursor, then press  to adjust the vertical cursor at left/right half screen to the middle.
5. In X-axis, quickly adjust the horizontal cursor at top/bottom half screen to the middle: press  to choose horizontal cursor, then press  to adjust the horizontal cursor at left/right half screen to the middle.

Move the waveform out of range the screen shown in picture 3-48, after “To 50%” is shown in picture -49.

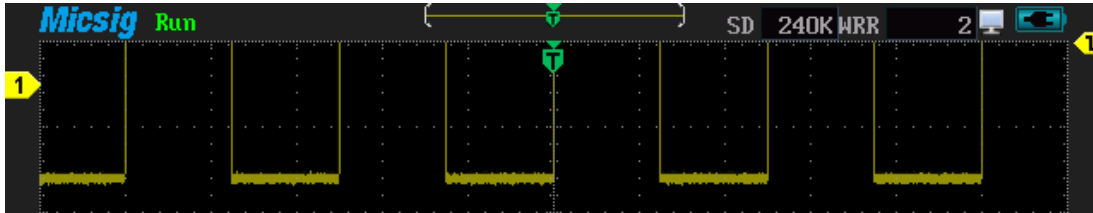

Picture 3-48 Vertically move upward waveform leaking out the screen

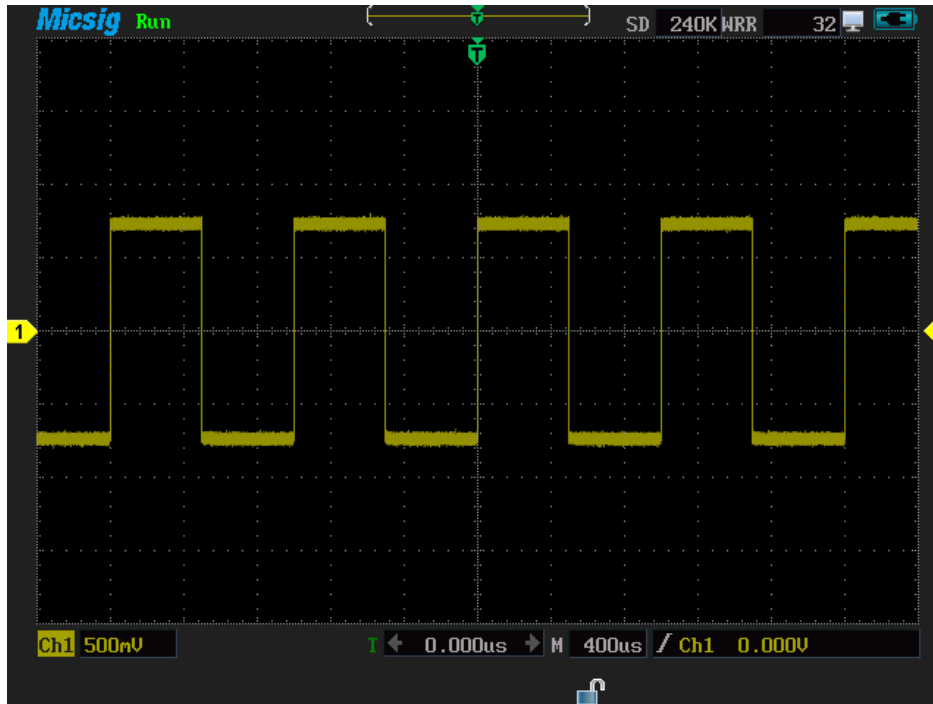

Picture 3-49 After using 50% shortcut

3.20 Use touch screen zoom waveform

Using the touch screen can easily zoom waveform to view waveform details, save operation time. Zooming operation only can be performed in the waveform zooming area.

Please follow these steps to use touch screen enlarge waveform:

1. Press touch screen, select enlarge area in the upper left corner, and then drag the magnified area at the bottom right corner, rectangular frame appears in picture3-50

Note: Drag the touch screen from left to right to amplify waveform, and drag from right to left to shrink waveform.

2. Release the touch screen, waveform amplifies automatically. See picture 3-51

Rectangular frame selection:

Zoom ratio is associated with the size of the magnified area. The smaller of the size, the bigger of the ratio and vice versa. The center position of waveform in magnified zone that will be moved to the center of screen, vertical position remains the same. Make sure the position not move while zoom out.

Use touch screen zoom waveform

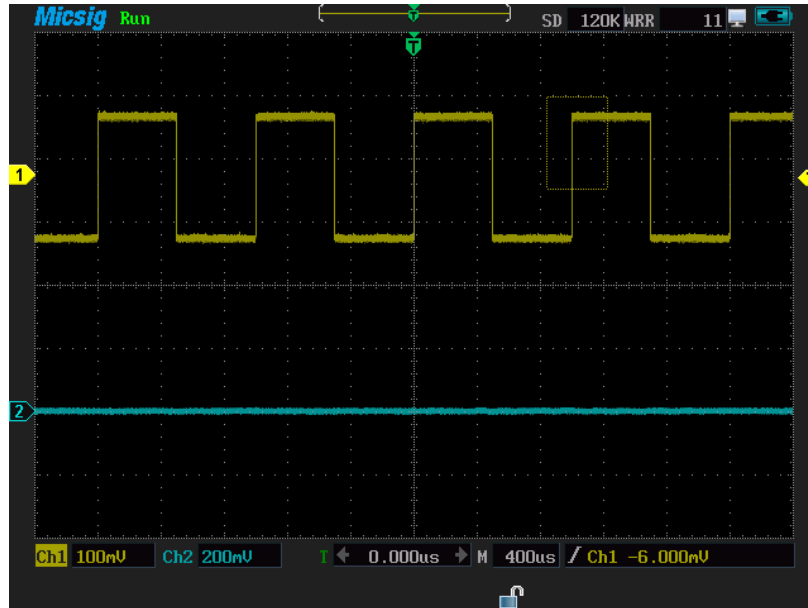

Picture 3 -50 Magnify selection area

Use touch screen zoom waveform

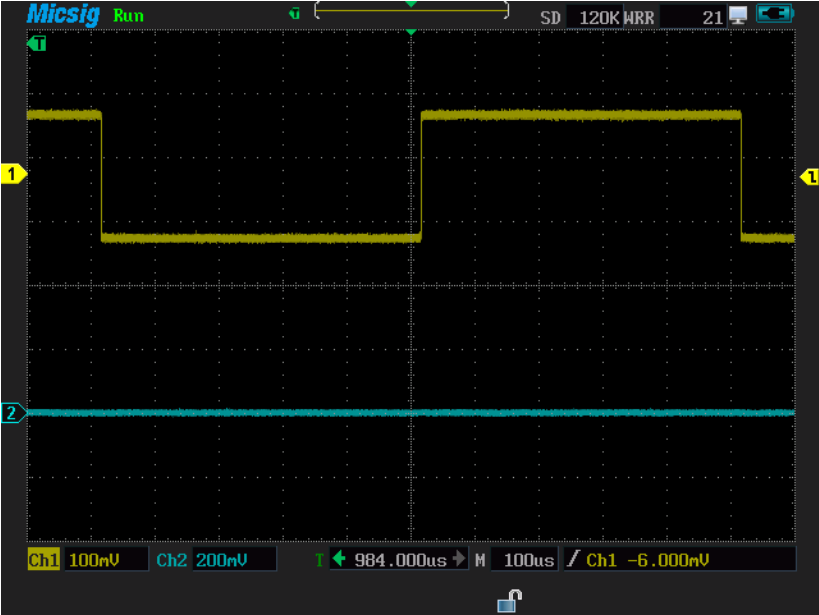

Picture 3-51 magnified waveform





Chapter Four Serial Bus Trigger& Decode

This chapter contains the detailed information of serial bus decoding. Recommend you read this chapter carefully to understand the setting and operation of a handled multi-function oscilloscope bus trigger and decode.

Note: MS300 Series, MS510IT and MS520IT need be updated to get decode function; MS510S and MS520S have series bus decode function;

This chapter mainly include the below contents:

- UART (RS232/RS422/RS485) bus trigger and decode
- LIN bus trigger and decode
- CAN bus trigger and decode
- SPI bus trigger and decode
- I2C bus trigger and decode

Press  then  and  to select serial bus, enter serial bus decode mode, press  to select one kind of bus type, there are UART (RS232/RS422/RS485) /LIN/CAN/SPI/I2C five kind of types. Each one has two kind of display mode: graphic and raw text modes. Press  to switch.

In serial bus decode mode, below is the default settings:

- Auto-set, measure, cursor, reference and math functions are out of use, the signal inversion function is also forbidden.
- Press the save/recall button can take snapshot of the screen
- When dual channels open, waveform drawing mode is “line”, the bandwidth is full bandwidth, the sampling mode as normal, the time base is YT-mode, refresh rate as high refresh rate, memory depth is 120 k
- If system in rolling in other modes switch to the serial decode, the time base automatically adjust to 40 ms(the maximum time base in the serial bus decode

mode)

The bus type selection dialog is shown in picture 4-1

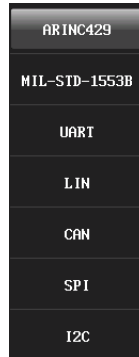

Picture 4-1 the bus type selection dialog

4.1 UART (RS232/RS422/RS485) bus trigger and decode

For correctly decoding UART(RS232/RS422/RS485) bus data and making trigger stable, users should adjust the bus configuration, trigger mode set and trigger level.

UART (RS232/RS422/RS485) bus trigger and decode

● Bus configuration



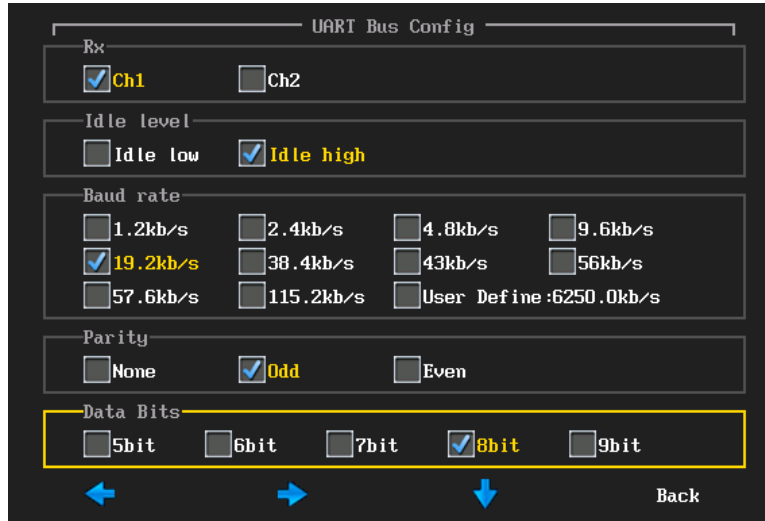



- (1) Press **F3** and then popup bus configuration dialog, set Rx channel, idle level, baud rate, parity, data bits, see picture 4-2.



Picture 4-2 UART bus configuration dialog

UART (RS232/RS422/RS485) bus trigger and decode

Note: the yellow rectangle box means the selection is in set, (v) means selected, in the above picture it is setting data bits, the selected are Ch1, idle high, 19.2kb/s, odd and 8bit.

- (2) Press   to choose left/right keys respectively. Press  to move downward cycle, press  to return. Set baud rate, using the buttons for user define. Press   or roll the wheel to adjusted value, if need user define, the touch screen pop up the virtual keyboard, at the user define area, input values, press Enter on the virtual keyboard. The virtual keyboard is shown in picture 4-3.

UART (RS232/RS422/RS485) bus trigger and decode



Picture 4-3 virtual keyboard

Note: If parity bit, data length equals data bits plus parity bit. If no parity bit, data length is data bits. For example, data length is 8 bit, total data bit is 8 bit if parity bit exist, If not, total data bit is 7 bit and 1 parity bit.



● Trigger mode

- (1) press to open the trigger configuration menu, set the trigger type, trigger relation and trigger data, see picture 4-4.

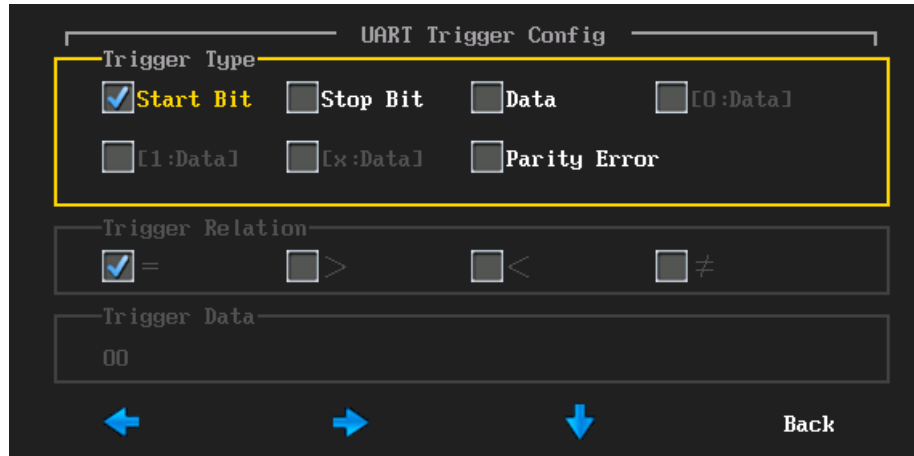

UART (RS232/RS422/RS485) bus trigger and decode



Picture 4-4 UART trigger configuration menu

- (2) Press **F1** **F2** to select left/right respectively, press **F3** to move downward cycle, press **F4** to back; after selecting the trigger data, press   or roll the wheel to adjust, or press the data on the touch screen, or use the virtual keyboard to modify;

UART trigger configuration menu descriptions:

- a) Start bit — trigger at the start bit of the measured signal
- b) Stop bit — trigger at the stop bit of the measured signal, no matter the measured signal uses 1, 1.5, or 2 stop bits or not, the trigger will occur at the first stop bit.
- c) **【data】** — Trigger at the specified data bit, when measured signal data bits are effective as five to eight bits, select the data, and select the trigger relationship as =, >, <, ≠, then select the trigger data, press   or roll the wheel to adjust, or press the data on the touch screen, using the virtual keyboard to modify.
- d) **【0: data】** —the measured signal data bits is nine. Only when the ninth bit is zero, then trigger. The trigger relation, trigger data configuration and data, trigger simultaneously.
- e) **【1: data】** —the measured signal data bits is nine. Only when the ninth bit is one, then trigger. The trigger relation, trigger data configuration and data, trigger simultaneously.
- f) **【x: data】** — the measured signal data bits is nine. Only when the ninth bits is X, then trigger. The trigger relation, trigger data configuration and data, trigger simultaneously;

UART (RS232/RS422/RS485) bus trigger and decode

g) Parity error — parity bit is valid at parity error, trigger while parity error.

The measured signal data bits is 8bit, parity bit, odd, baud rate, 19.2kb/s, trigger mode as start bit, follow the steps as below:

- (1) In working mode, press **Trigger**, then press **F1** to select the trigger type as serial bus.
- (2) Press **F2** to select bus type as UART.
- (3) Press **F3** to popup bus configuration menu, select Ch1, idle high, 19.2kb/s, odd, 9bit, then press **F4** to back
- (4) Press **F4** to pop-up trigger mode Setting menu, press the start, then press **F4** to back.

UART (RS232/RS422/RS485) bus trigger and decode

- (5) According the signal amplitude to adjust trigger level, UART trigger graphical interface is shown in picture 4-5, text interface is shown in figure 4-6.

UART (RS232/RS422/RS485) bus trigger and decode

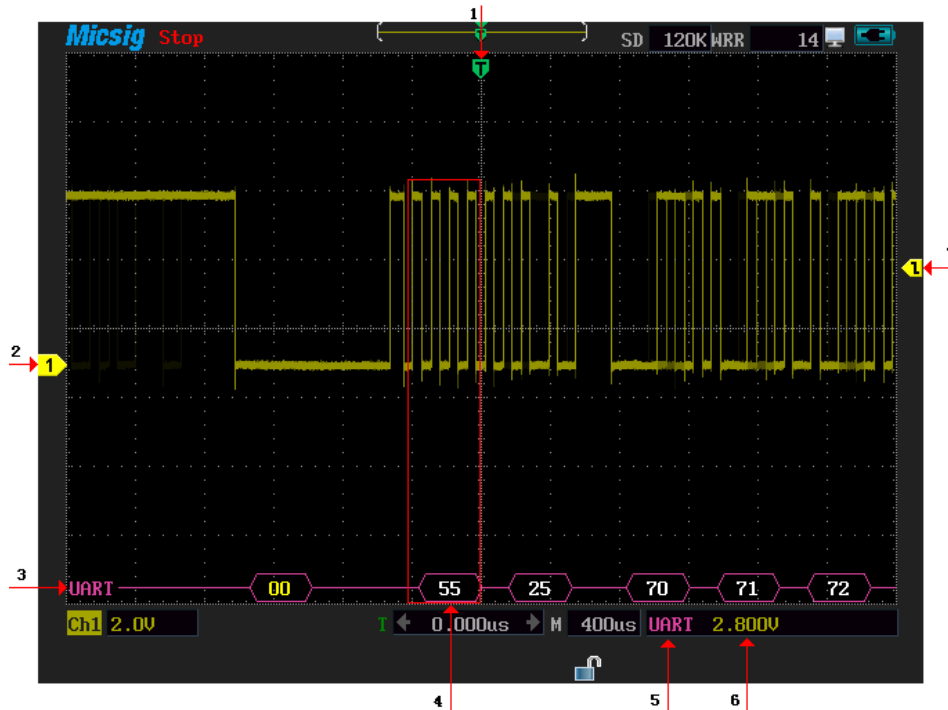

Picture 4-5 UART graphic interface

UART (RS232/RS422/RS485) bus trigger and decode

UART interface:

1. Trigger position
2. Signal source Ch1
3. Decode packets
4. Decode the data and the corresponding waveform
5. Bus type
6. Trigger level value
7. Trigger level

Description of decode content

- (1) Decode packet displays real-time data about the bus activities
- (2) the Decode data displays as hexadecimal system in white
- (3) data bits is 5-8 bits, the decode data displays as two bits of hexadecimal, when data bits is 9, the decode data displays as 3 bits of hexadecimal, the ninth bit displays at the left side.
- (4) when decode data is error, if the error is at stop bit, data displays in yellow, if parity error,

UART (RS232/RS422/RS485) bus trigger and decode

data displays in red

(5)when appear ?, users need to press  to adjust the timescale, and then view the decode results.

UART (RS232/RS422/RS485) bus trigger and decode

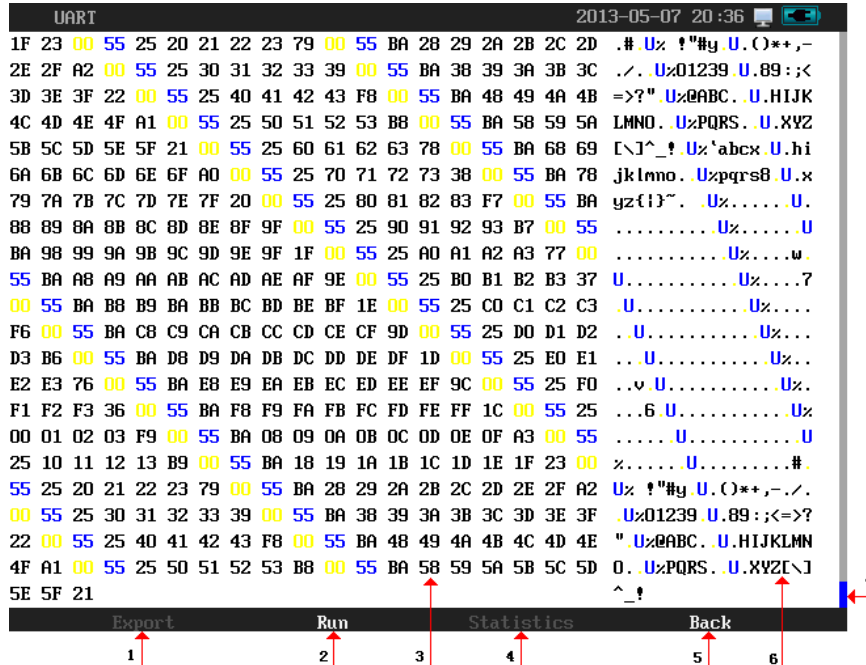

Picture 4-6 UART text interface

UART (RS232/RS422/RS485) bus trigger and decode

Descriptions of UART text interface.

1. Export: Export data (workable after USB storage device connected)
2. Run/stop: Run/stop decode
3. Area for decode data
4. Statistics: statistic the frame type, etc., only effective in CAN bus decoding mode
5. Return: Return to upper interface
6. The text data corresponding to ASCII (if the data bits is 9 bit and no parity error, ASCII is corresponding to the low 8 bit in the left side)
7. Roll bar: In decode data area, data reaching the trigger condition is shown as blue ,the missing data at stop bit is shown as yellow, the red is error-decode data.

4.2 LIN bus trigger and decode

For the correctly decoding LIN bus data and making trigger stable, users need bus configuration, trigger mode configuration, and trigger level adjustment.

- **Bus configuration**

Press **F3** to popup bus configuration dialog, set the signal source, the idle level, baud rate, the setting method is the same as the UART. See picture 4-7.

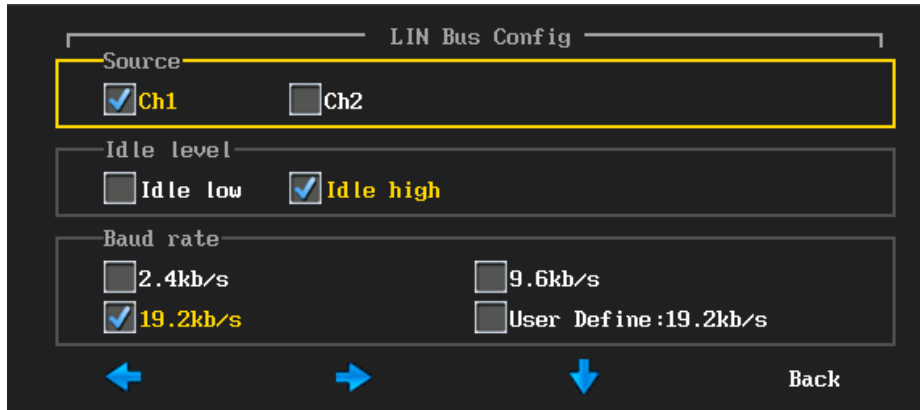

Picture 4-7 LIN bus configuration menu

- **Trigger type**

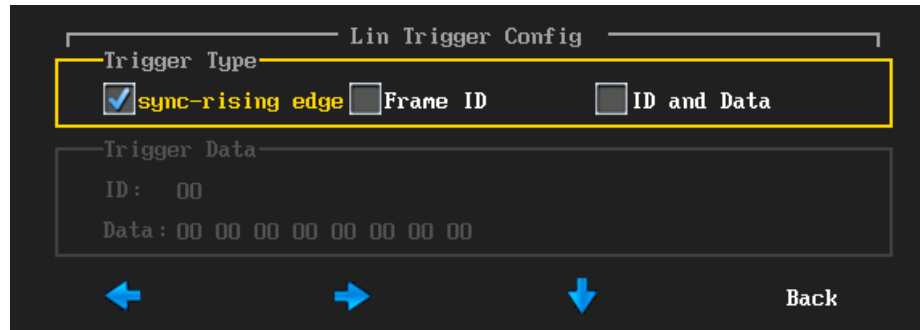

Press **F4** to pop-up trigger mode configuration dialog. Trigger types include sync- rising

edge, frame ID and ID data, see picture 4-8.



Picture 4-8 LIN trigger configuration mode menu







- a) Sync-rising edge —when the sync interleaved of LIN bus is over, sync-rising trigger begins to work.
- b) Frame ID — Triggered once the detected ID is equal to the frame trigger value.

Select frame ID, press   or roll the wheel to adjust, or press the data on the touch screen, using the virtual keyboard to modify.

- c) Frame ID and data — Triggered once the detected ID and the data are equal

to the trigger value. After selecting the frame ID and data, press the ID and data to set the ID and the data values. Connect Ch1 to the measured signal, the idle level is high, the baud rate is 19.2 KB/s.

Please follow these steps to sync- rising edge type

- (1) In oscilloscope function mode, press , then press  to select trigger type as serial bus trigger;
- (2) Press  to select bus type as “LIN”;
- (3) Press , then popup bus configuration menu. Successively press Ch1, idle high, 19.2kb/s, then press  to return;
- (4) Press , then popup configuration of trigger type, select sync- rising edge, then press  to back.

- (5) According signal amplitude to adjust the trigger level, LIN trigger interface as shown in picture 4-9, text interface as shown in picture 4-10.

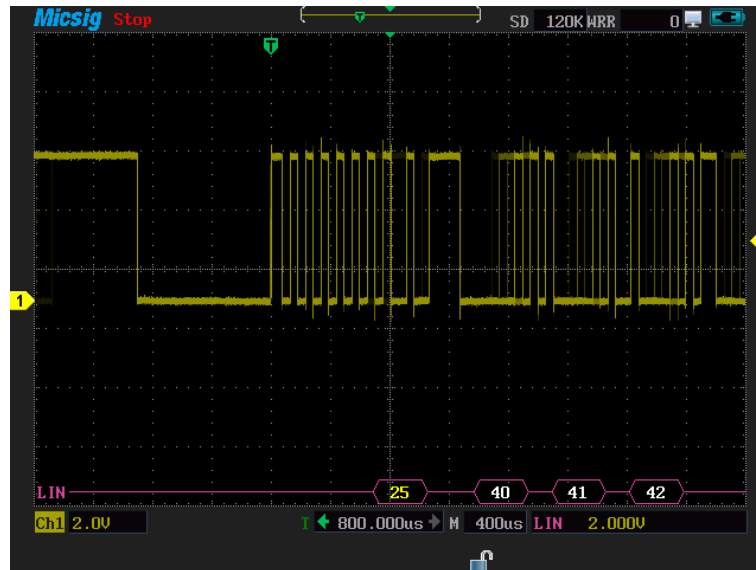

Picture 4-9 LIN graphic interface

Description of LIN decode

(1)Decoding packet shows real-time data contents of bus activities

(2)Decode data is based on hexadecimal

(3)Frame ID displays in yellow, data displays in white and the sum of parity displays in green, red for the sum of parity error.

(4)when appear ?, need press to adjust time scale, and then view the results.

LIN bus trigger and decode

LIN		2013-05-07 20:42				
Time (ms)	ID	Data	Check	Sum	Trig	
7.17	3A	38 39 3A 3B 3C 3D 3E 3F	22		Yes	
8.06	25	40 41 42 43	F8		Yes	
7.17	3A	48 49 4A 4B 4C 4D 4E 4F	A1		Yes	
8.19	25	50 51 52 53	B8		Yes	
7.17	3A	58 59 5A 5B 5C 5D 5E 5F	21		Yes	
8.19	25	60 61 62 63	78		Yes	
7.04	3A	68 69 6A 6B 6C 6D 6E 6F	A0		Yes	
8.19	25	70 71 72 73	38		Yes	
7.17	3A	78 79 7A 7B 7C 7D 7E 7F	20		Yes	
8.19	25	80 81 82 83	F7		Yes	
7.17	3A	88 89 8A 8B 8C 8D 8E 8F	9F		Yes	
8.06	25	90 91 92 93	B7		Yes	
7.17	3A	98 99 9A 9B 9C 9D 9E 9F	1F		Yes	
8.19	25	A0 A1 A2 A3	77		Yes	
7.17	3A	A8 A9 AA AB AC AD AE AF	9E		Yes	
8.19	25	B0 B1 B2 B3	37		Yes	
7.17	3A	B8 B9 BA BB BC BD BE BF	1E		Yes	
8.06	25	C0 C1 C2 C3	F6		Yes	
7.17	3A	C8 C9 CA CB CC CD CE CF	9D		Yes	
8.19	25	D0 D1 D2 D3	B6		Yes	
7.17	3A	D8 D9 DA DB DC DD DE DF	1D		Yes	

Picture 4-10 LIN text interface

Description of LIN text interface

- (1) Time: Time intervals between the last frames to current frames
- (2) ID: Frame ID value
- (3) Data: Frame data
- (4) Parity sum: Frame parity sum, the sum of parity error displays in red
- (5) Trigger: Yes means the frame reaches trigger condition

4.3 CAN bus trigger and decode

For the correctly decoding CAN bus data and making trigger stable, need bus configuration, trigger configuration type, and adjustment trigger level.

- **Bus configuration**

Press  to Popup bus configuration menu, users need to set the signal source, idle level, baud rate; Setting method is the same as the UART, picture 4-11.



Picture 4-11 CAN bus configuration menu

- **Trigger type**



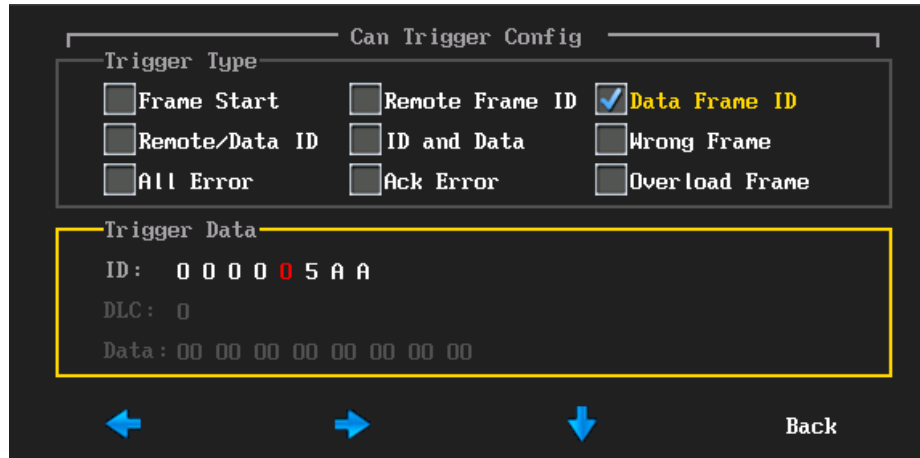

Press F4 to popup trigger type setting menu, picture 4-12



Picture 4-12 configuration trigger type menu

Description of trigger mode menu







- Frame start— trigger at the start of the frame
- Remote frame ID — setting the ID matches the remote frame trigger. After selecting the remote frame ID, and then set the ID value at the bottom of the trigger data area.

operation instructions: press  to left selection, press  to right selection, then press   or roll the wheel to set frame ID value, then press  to back. Users can press the numbers on the touch screen or use the virtual keyboard to set.

- c) Data framed ID — setting ID that matches the data frame trigger. Data frame ID configuration mode with the remote frame ID at the same configuration
- d) Remote frame/data frame ID — the frame set ID that matches the remote or data frame. Remote frame/frame ID configuration with the remote data frame ID at the same configuration
- e) Data frame ID and data ID — setting the ID data matches data frame ID. The configuration method is the same as remote frame ID configuration;
- f) Wrong frame —wrong frame CAN trigger
- g) All error—trigger when any error format or activity

- h) Ack error— recessive Ack position trigger
- i) Over load frame —overload frame CAN trigger

Ch1 connect to measured signal channel, the idle level is high, 1 MB/s baud rate; frame start as the trigger mode, Please follow these steps:

- (1) In oscilloscope function mode, press  then , select the trigger type as serial bus
- (2) Press  to select bus type as CAN
- (3) Press  to popup the CAN bus configuration menu, successively press Ch1 then idle high, 1Mb/s , press  to back
- (4) Press  to popup configuration trigger mode menu, press frame start
- (5) Based on signal amplitude to adjust the trigger level. CAN trigger interface is shown in figure 4-13, Text interface is shown in picture 4-14.

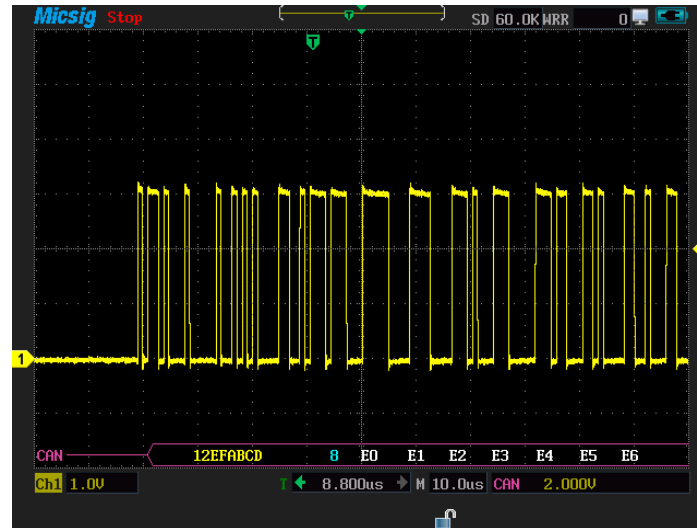

Picture 4-13 CAN graphic interface

Instruction of CAN decode data packet:

- (1) Decode packet displays instantaneity data content of bus activity
- (2) Decode data is based on hexadecimal.
- (3) Frame ID displays in yellow, the data in white, the DLC and CRC code display in green, the

frame error displays in red E

(4)when appear ?, need press  to adjust time scale, then view the decode results.

When appear ! , means the decode packet of the bus waveform is not complete, so data does not displayed properly.

CAN bus trigger and decode

2013-01-02 06:13							
Time (ms)	ID	Type	DLC	Data	CRC	Error	Trig
0.13	12EFABCD	EFF	8	F0 F1 F2 F3 F4 F5 F6 F7	1AB7	Ack	Yes
0.13	12EFABCD	EFF	8	F0 F1 F2 F3 F4 F5 F6 F7	1AB7	Ack	Yes
0.13	12EFABCD	EFF	8	F0 F1 F2 F3 F4 F5 F6 F7	1AB7	Ack	Yes
0.13	12EFABCD	EFF	8	F0 F1 F2 F3 F4 F5 F6 F7	1AB7	Ack	Yes
0.13	12EFABCD	EFF	8	F0 F1 F2 F3 F4 F5 F6 F7	1AB7	Ack	Yes
0.13	12EFABCD	EFF	8	F0 F1 F2 F3 F4 F5 F6 F7	1AB7	Ack	Yes
0.26	12EFABCD	EFF	8	F0 F1 F2 F3 F4 F5 F6 F7	1AB7	Ack	Yes
0.13	12EFABCD	EFF	8	F0 F1 F2 F3 F4 F5 F6 F7	1AB7	Ack	Yes
0.13	12EFABCD	EFF	8	F0 F1 F2 F3 F4 F5 F6 F7	1AB7	Ack	Yes
0.13	12EFABCD	EFF	8	F0 F1 F2 F3 F4 F5 F6 F7	1AB7	Ack	Yes
0.13	12EFABCD	EFF	8	F0 F1 F2 F3 F4 F5 F6 F7	1AB7	Ack	Yes
0.13	12EFABCD	EFF	8	F0 F1 F2 F3 F4 F5 F6 F7	1AB7	Ack	Yes
0.13	12EFABCD	EFF	8	F0 F1 F2 F3 F4 F5 F6 F7	1AB7	Ack	Yes
0.13	12EFABCD	EFF	8	F0 F1 F2 F3 F4 F5 F6 F7	1AB7	Ack	Yes
0.26	12EFABCD	EFF	8	F0 F1 F2 F3 F4 F5 F6 F7	1AB7	Ack	Yes
0.13	12EFABCD	EFF	8	F0 F1 F2 F3 F4 F5 F6 F7	1AB7	Ack	Yes
0.00	12EFABCD	EFF	8	F0 F1 F3		D.Bit	Yes
0.38	02A	SFF	5	F8 F9 FA FB FC	3502	Ack	
0.26	12EFABCD	EFF	8	F8 F9 FA FB FC FD FE FF	2F35	Ack	Yes
0.26	12EFABCD	EFF	8	F8 F9 FA FB FC FD FE FF	2F35	Ack	Yes

Export Run Statistics Back

1 2 3 4

Picture 4-14 CAN text interface

CAN text interface description:

1. Export: after USB connected, data can be exported
2. Run/stop: run/stop decode
3. Statistics: statistic frame type, data bit and trigger count and percentage. As shown in picture 4-15
4. Back: back to graphic pattern
5. Trigger: Yes means the frame conforms to trigger condition
6. Error: includes response error, bit stuff error, format error and CRC error
7. CRC: the frame parity code
8. Data: refer to frame data
9. DLC: when the frame send data bit or remote frame, user can ignore this value
10. Type: includes types of the frame, SFF means standard data frame and SRF is standard remote frame , EFF is extension data frame, ERF is the extension of remote frame
11. ID: CAN frame ID value, displays as hex, max is 29 bit
12. Time: means the time interval between the last frames to current frame.

CAN bus trigger and decode

CAN		2013-01-02 06:14
Item	Count	Percent(%)
->Bit Error	276	0.71
->ID Bit Error	115	0.29
->Data Bit Error	161	0.41
->Frame Format Error	2	0.01
->Frame End Error	2	0.01
->Frame ID	39014	100.00
->0x12EFABCD	38511	98.71
->0x977D5E1F	17	0.04
->0x5AA	391	1.00
->0x977D5E10	24	0.06
->0x1	4	0.01
->0x98	3	0.01
->0x977D60	25	0.06
->0x977F	6	0.02
->0x97	17	0.04
->0x977D5E0E	1	0.00
->0x977D5E0D	3	0.01
->0x0	3	0.01
->0x0	2	0.01
->0x977D5E0F	16	0.04
->0x977D5F	1	0.00

Export Run Statistics Back

Picture 4-15 CAN decode statistics

4.4 SPI bus trigger and decode

For correctly decoding SPI bus data and making trigger stable, bus configuration, trigger type configuration and trigger level adjustment are needed.

- **Bus configuration**

- (1) Press  to popup bus configuration, then user need set the clock source(CLK), data source, work mode and data bits. As shown in figure 4-16.

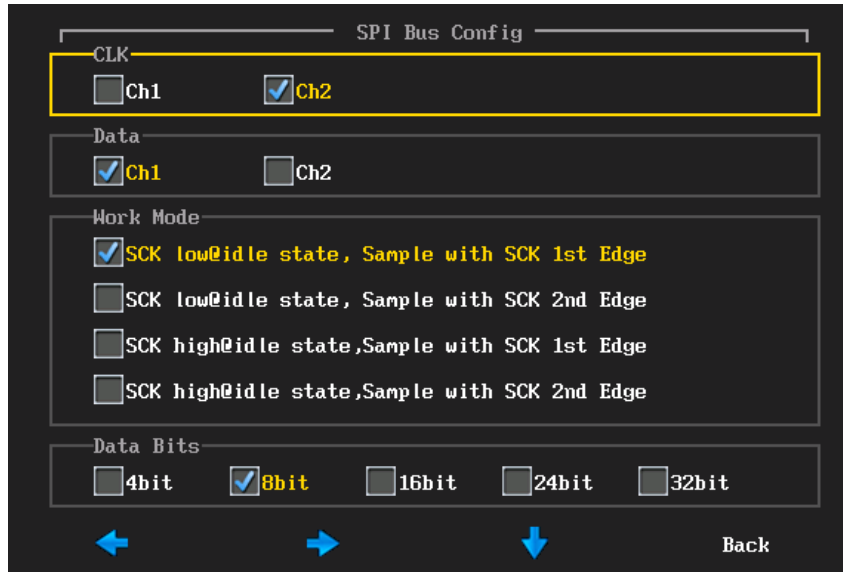

Picture 4-16 SPI bus configuration menu

- **Trigger mode**

Press **F4**, popup trigger mode configuration menu, shown in picture 4-17.

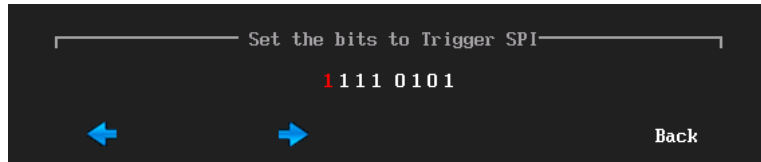

Picture 4-17 SPI matching bit settings menu

The method for operation is same as configuration of CAN and frame ID.

Notes: According the bus decode to set data bits, if the data bits matches the given bits can realize trigger.

Measured signal length is 8 bit; trigger mode matching bit is 11110101, Ch2 connect to CLK, Ch1 connect to DATA, bus is idle for low level, Please follow these steps for clock rising samples;

- (1) In oscilloscope function mode, press **Trigger**, then press **F1** select the trigger type as serial bus
- (2) press **F2** to select bus type as SPI

- (3) press **F3** to enter the bus configuration menu, successively press the CLK of Ch2, data as Ch1, work mode as SCK low idle state, sample with SCK is edge, data bits is 8bit, after finishing set then press **F4** to back to upper menu.
- (4) press **F4** to enter the bit matching menu, press the data on the touch screen, Using the virtual keyboard to set the matching bit is 11110101;
- (5) According the signal amplitude to adjust the two channels' trigger level; SPI trigger interface is shown in picture 4-18.



Picture 4-18 SPI trigger graphic interface

Description of SPI decoding

(1) Decode packet displays the real-time data content of bus activity

(2) Decode data displays as hexadecimal system

(3) Data displays in white

(4) When appear?, need to press  to adjust time scale, then view the decode results.

SPI bus trigger and decode

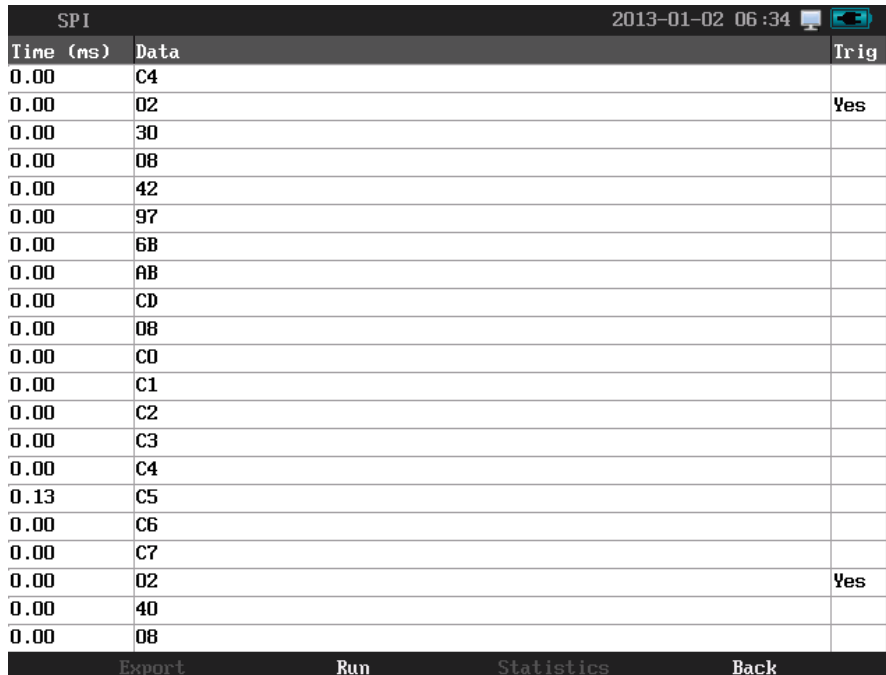

The screenshot displays a terminal window titled "SPI" with a timestamp of "2013-01-02 06:34". The window contains a table with three columns: "Time (ms)", "Data", and "Trig". The data rows show a sequence of hexadecimal values from C4 to 08, with a jump to C5 at 0.13 ms, followed by C6, C7, and 02. The "Trig" column has "Yes" entries for the first and second occurrences of 02.

Time (ms)	Data	Trig
0.00	C4	
0.00	02	Yes
0.00	30	
0.00	08	
0.00	42	
0.00	97	
0.00	6B	
0.00	AB	
0.00	CD	
0.00	08	
0.00	C0	
0.00	C1	
0.00	C2	
0.00	C3	
0.00	C4	
0.13	C5	
0.00	C6	
0.00	C7	
0.00	02	Yes
0.00	40	
0.00	08	

At the bottom of the window, there are four menu options: "Export", "Run", "Statistics", and "Back".

Picture 4-19 SPI text interface

SPI text interface specification:

(1) Time: Intervals from the last frame to current frame

(2) Data: According the decode data bits display decode data. Such as, the data bits is 8 bits, can only display 1 byte on data bar. If data bits are 16 bits, the data bar shows 2 bytes; 24 data bits display 3 bytes; Data bits are 32 bits, then 4bytes.

(3) Trigger: Yes means the frame reaches the trigger condition.

Notes: Single frame refers to the measurement of settled data bits; it can meet a data bit code stream

4.5 I2C bus trigger and decode

For correctly decoding 12C bus data and making trigger stable, user need adjust bus configuration, trigger mode configuration and trigger level.

● **Bus configuration**

Bus configuration includes the serial clock (SCL) and the serial data (SDA) corresponding to the channel settings.

Press **F3**, then popup bus configuration menu, press the channel on the touch screen or use a function button to set. As shown in picture 4-20.

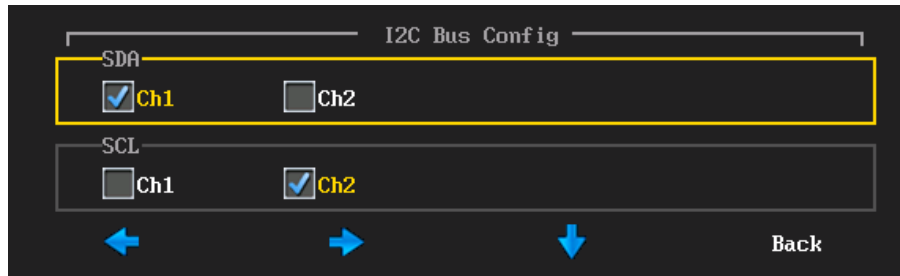

Picture 4-20 I2C bus configuration

Notes: When finish the setting of SCL or SDA channel, the system will automatically set other channels.

- **Trigger type**

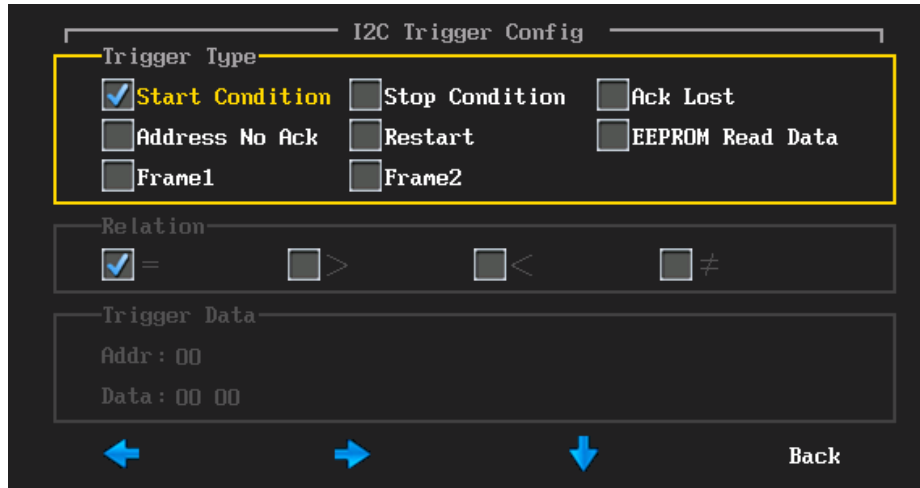

Press **F4** to popup trigger type configuration menu, press the trigger type and trigger relation on touch screen, or select by using the function keys, as shown in picture 4-21.





Picture 4-21 I2C trigger type configuration menu

Specification of trigger type menu:

- a) Start condition — when SCL is high, the SDA begins fall trigger(includes restart)
- b) Stop condition — when SCL is high, the SDA begins rise trigger
- c) Ack Lost —bus Ack high level trigger



- d) Address no Ack — trigger at the setting address no Ack (ignoring W/R), select the trigger data address, press   or roll the wheel to set data value, users can also press the address or data on touch screen or use the virtual keyboard to set data value.
- e) Restart — trigger when new restart condition appears before the stop.
- f) EEPROM read data — when the read operation which contains 1010xxx control byte of the EEPROM appears on the bus and the ACK is correct, then the instrument can capture the read data, if the capture data and the set data accord with the given relation condition, trigger after data byte confirms the clock edge. After selecting EEPROM read data, then press the relationship by "=", ">" "<", "≠", the method is same as the address no ACK set.
- g) Frame type 1 — start + address 7+ read/write+ confirm +data; If all bits of the frame types match, on the 17th clock edge, trigger at the address 7 frame of read/write

Frame type 1 operation method: select the value behind the address/data, press   or roll the wheel to adjust value; Select the value behind the address/data on the virtual keyboard.

h) Frame type 2, start + address7 + read/write + confirm + data1 + data2;

If all bits of the frame type match, then on the 26th clock edges, trigger at the address 7 frame of read/write. The configuration frame type 1 is the same as the operation method of the 2 frame.

Trigger mode is the start condition, SCL connect to Ch2, SDA connect to Ch1, follow these steps as below

- (1) In work mode, press , then press , select the trigger type as serial bus
- (2) Press  to select bus type as I2C

- (3) Press **F3** to popup bus configuration menu, then select the SCL as Ch2, at last press **F4** to back to upper menu;
- (4) Press **F4** to popup trigger mode of configuration menu, press start condition on touch screen, the set is finished, then press **F4** return to upper menu;
- (5) According the signal amplitude to set the two channels' trigger level. I2C trigger interface is shown in picture 4-22, text interface is shown in picture 4-23.

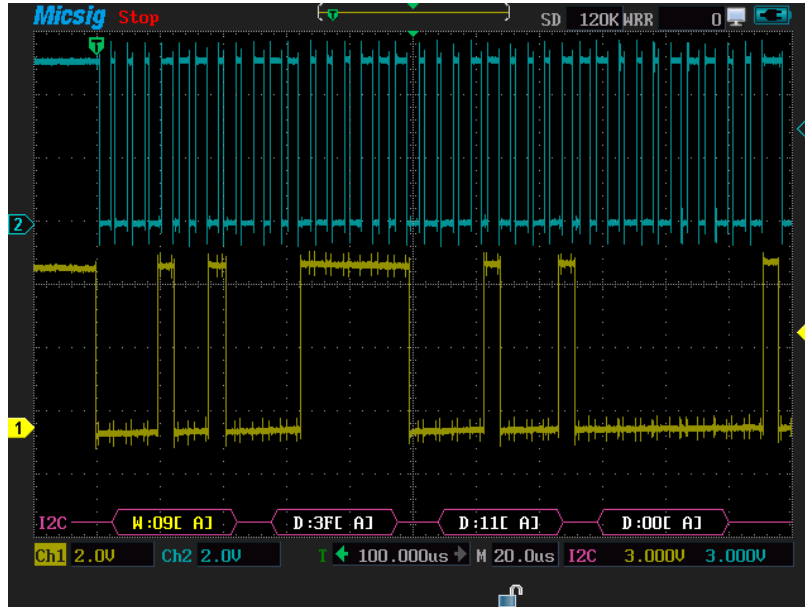

Picture 4-22 I2C graphic interfaces

Description of I2C decode content

(1) Decode packet displays the real-time data content of bus activity

(2) The decode data displays Hexadecimal system

(3) Address content shown in yellow, data in white W means work, R means read, D means decode, ~A means Ack.

(4) When appear ?, need to press  to adjust time scale, then view the decode results.

I2C bus trigger and decode

I2C				2013-01-02 06:42		
Time (ms)	Addr	Data	Ack	Trig	ReSet	
0.64	50R	43 44 45 46 47 48 49 4A 4B 4C 4D	X	Yes	Yes	
14.21	09W	3F 4E 00		Yes		
0.13	09W	3F		Yes		
0.13	09R	4E 4F	X	Yes		
0.13	50W	00 00		Yes		
0.64	50R	50 51 52 53 54 55 56 57 58 59 5A	X	Yes	Yes	
14.34	09W	3F 5B 00		Yes		
0.00	09W	3F		Yes		
0.26	09R	5B 5C	X	Yes		
0.13	50W	00 00		Yes		
0.64	50R	5D 5E 5F 60 61 62 63 64 65 66 67	X	Yes	Yes	
14.21	09W	3F 68 00		Yes		
0.13	09W	3F		Yes		
0.13	09R	68 69	X	Yes		
0.26	50W	00 00		Yes		
0.64	50R	6A 6B 6C 6D 6E 6F 70 71 72 73 74	X	Yes	Yes	
14.21	09W	3F 75 00		Yes		
0.13	09W	3F		Yes		
0.13	09R	75 76	X	Yes		
0.13	50W	00 00		Yes		
0.64	50R	77 78 79 7A 7B 7C 7D 7E 7F 80 81	X	Yes	Yes	

Export

Run

Statistics

Back

Picture 4-23 I2C text interface

Description of I2C text interface

- (1) Time: Intervals between the last read/write operations to current read/write operations
- (2) Address in address bar the "R" means the read operation, the "W" means write operation
- (3) Ack: In Ack bar "x" means Ack lost
- (4) Data: Data bar
- (5) Trigger: Yes means reach trigger condition
- (6) Restart: Yes means reach restart condition

Chapter Five Application Examples

This chapter mainly introduces five common applications:



- Taking simple measurements
- Capture single pulse signal
- Analyze signal detail
- Trigger on video signal
- Use math FFT

Each application example highlights the different characteristics of the oscilloscope; user can get familiar with the operation of oscilloscope through these application examples.

5.1 Taking simple measurement





Observe the signal waveform in the circuit and connect to the oscilloscope to show signal quickly; Auto-measure frequency, cycle, the average and peak-peak; the cursor is used to measure the peak and decay period.

1. Follow these steps to get quick display signal waveform:

- 1) connect Ch1 to the measured signal;
- 2) press  to switch Ch1 as the current channel (if Ch1 is already current, ignore this step)
- 3) press , then Oscilloscope automatically set vertical, horizontal and trigger; Users can also manually adjust the vertical and horizontal gear until the waveform conforms to your requirements.

2. Auto-measurement

Oscilloscope can automatically measure most signals, like signal frequency, period, the mean and peak - peak, follow these steps

- 1) Press , see the measure type menu.
- 2) By pressing on the touch screen to select period, frequency, mean, peak-peak these four measurement options.
- 3) Press  then  then select trigger as Ch1
- 4) Press 



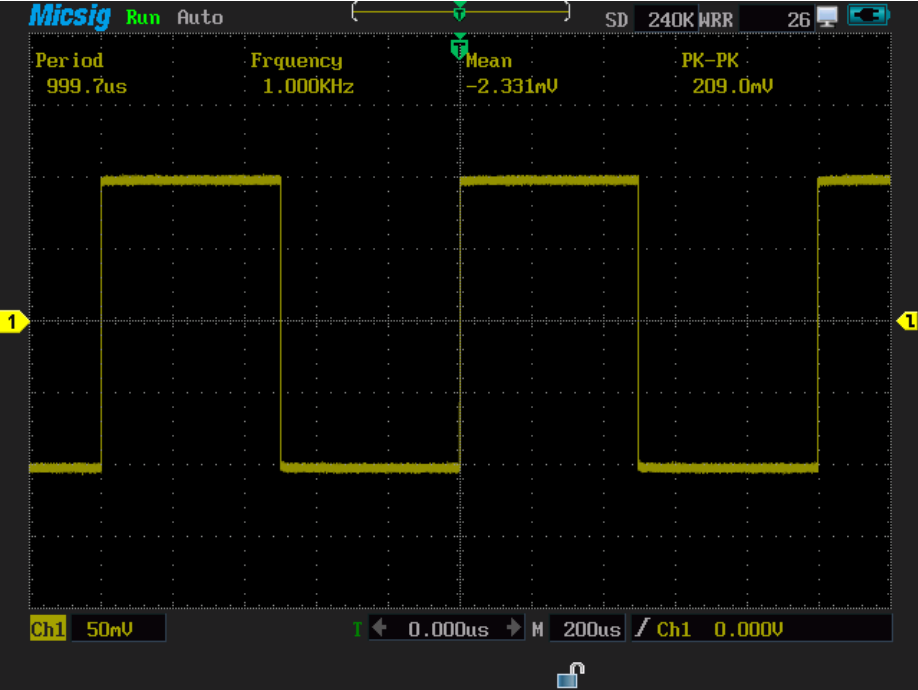





After auto-measurement finished, the results show on the screen, as shown in picture 5-1.





Picture 5-1 auto-measure

3. Cursor measurement

Using the cursor to quickly measure waveform, follow these steps to measure burst pulse.

- 1) Press  to open cursor menu
- 2) Press  to select the vertical cursor
- 3) Press  to close the cursor menu
- 4) Press   to move the cursor to the first wave of the first peak (notes: before moving the cursor should test the Cursor brightness on screen, if not, press  to switch)
- 5) Press  to open cursor menu
- 6) Press  to select the second cursor

- 7) Press   to move cursor to the second waveform attenuation after the second peak; the pulse peak is 9.593 V, decay period is 3.160 us, as shown in picture 5-2.

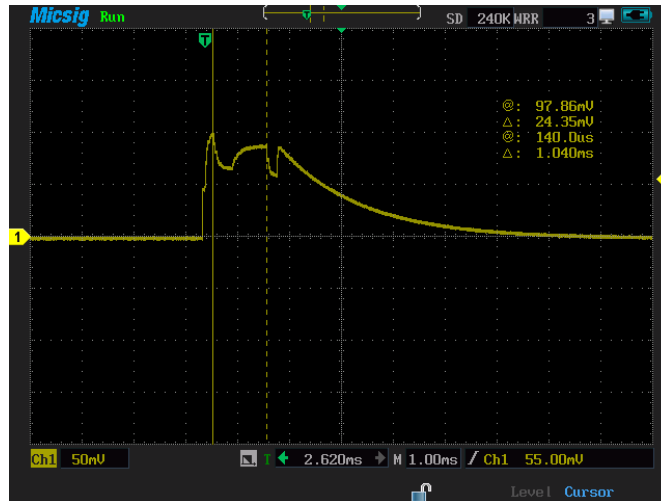















Picture 5-2 cursor measure

5.2 Capture single pulse signal

Capturing the pulse, burr and non-periodic signal are the advantage of digital oscilloscope. If you capture a single signal, require e some knowledge of signal and then you can correctly set trigger level and trigger. For instance, pulse is a TTL level logic signal, trigger level should be set to 2v, and the trigger mode is set as rising trigger. If you are not sure about the signal, you can identify the trigger level and trigger through the automatic mode.

Capturing single pulse signal should follow these steps.

- 1) connect Ch1 to signal
- 2) successively press  , then select sampling mode as peak
- 3) press  to open the trigger menu
- 4) press  to select the trigger type as the edge trigger

- 5) Press  to select signal source as Ch1
- 6) Press  to select slope as the rise, then press   or roll the wheel to adjust the trigger level.
- 7) Successively press   to select the coupling way as DC
- 8) Press  to select the mode as auto
- 9) Successively press  then  to set the rejection time as 200ns
- 10) Press  to wait for trigger and capture pulse.(view picture as5-3)
Then you can adjust the vertical scale factor, adjust horizontal time scale and trigger level to a suitable position, which is ready to capture in next time.

Capture single pulse signal

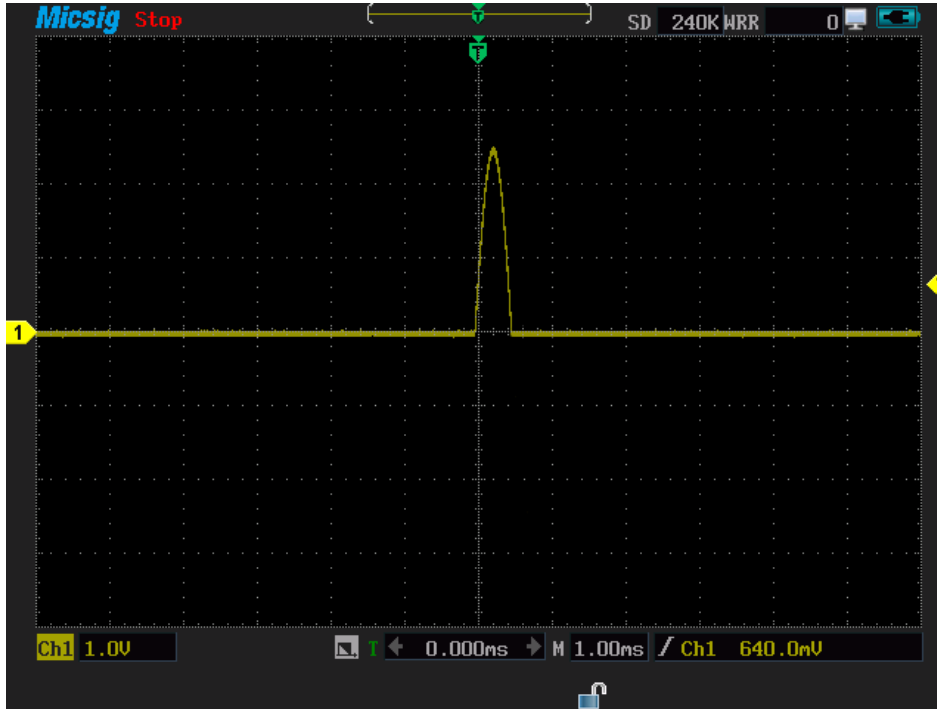



Picture 5-3 Capture the single pulse signal

5.3 Analyze the signal detail

If adding the random noise to the measured signal, you can adjust the settings to eliminate or reduce the noise and then avoid the interference to original signal.

1. Observe noisy signal

The circuit fault may happen by the interference of noise signal and for a better analysis of the noise, please follow these steps.

- 1) Connect Ch1 to signal.
- 2) Press  to open the oscilloscope menu.
- 3) Press  to select the sampling cfg as peak.

At this time, the screen displays random noise waveform and noise peak and burr can be observed with peak sampling. See picture 5-4.

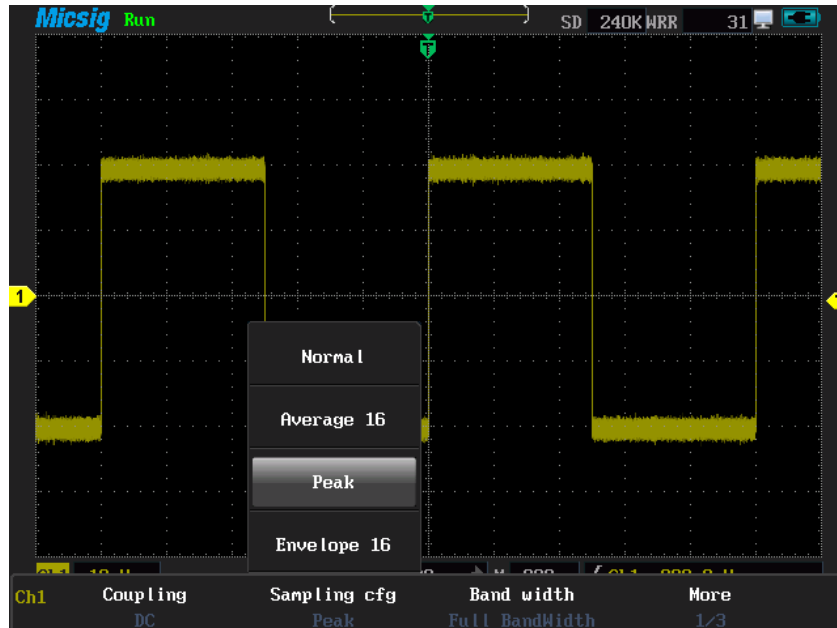



Picture 5-4 peak sampling cfg

2. Isolate signal from noise

Ignoring the noise while analyze signal, please following these steps to reduce random noise signal rejection.

1) Press  to open the oscilloscope menu

2) Press  to select sampling mode as average 16, averaging can reduce the signal noise and make the original signal easy to observe.



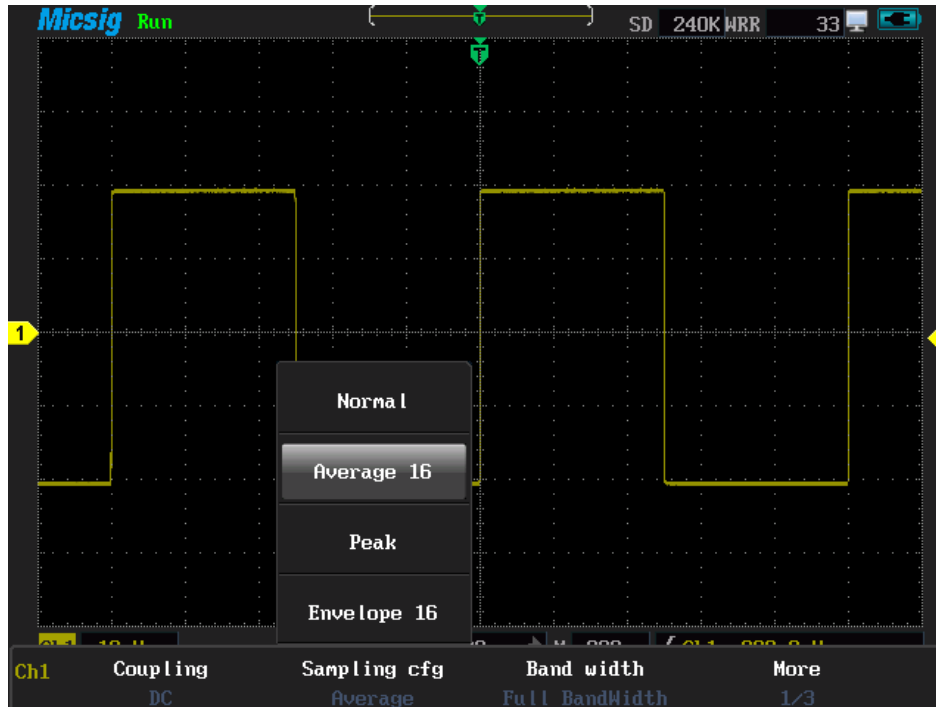





 **Attention: Using average sampling can slow the waveform update rate. This is a normal phenomenon. The larger of the average value, the slower of waveform display.**



Picture 5-5 average sampling

5.4 Trigger on video signal

To observe high definition 720P video circuit pattern signal, using video trigger to receive stable video output signal. Please follow these steps to use the default trigger mode and the hold-off time.

- 1) Connect Ch1 to measured signal.
- 2) Successively press   to select the trigger type as the video
- 3) Press  to select the signal source as Ch1.
- 4) Press  then  to select the video standard type as 1080P
- 5) press  to select the trigger type as all
- 6) Adjust the vertical scale factor , vertical position , horizontal time scale

s ns



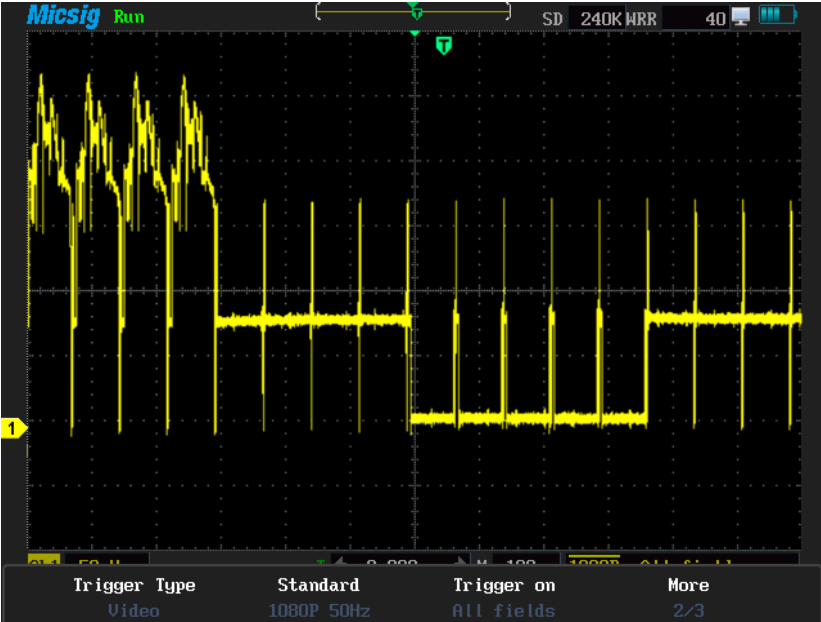

for suitable waveform display. As shown in picture5-6.



Picture 5-6 All 720P format

5.5 Use math FFT

FFT transforms signal from time domain to frequency domain, the oscilloscope displays the waveform signal in frequency domain. Please follow the steps to observe the frequency domain information of the square waveform signal.

- 1) Connect Ch1 to signal
- 2) Press  and  to select FFT
- 3) Press  to select the signal source as Ch1
- 4) Press  to select window as Hanning

FFT waveform is shown in picture 5-7

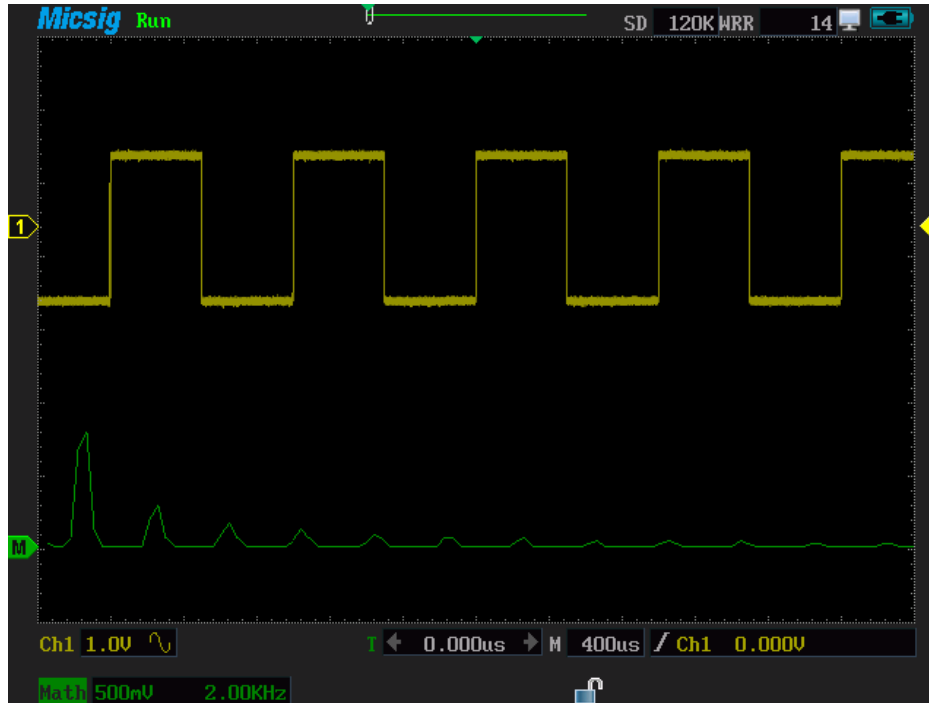

Picture 5-7 FFT waveform

Chapter Six Use Multimeter

This chapter mainly includes the following contents



- Multimeter safety information
- Start the multimeter
- Multimeter buttons and their functions
- Use multimeter

6.1 Multimeter safety information

- If the instrument damaged, do not use it.
- Check if the test pens are damaged, if yes, please replace them before using the instrument.
- Do not apply overload voltage to the terminal instrument as regulation.
- While using current module to measure current, users should first turn off the power supply of the circuit which is under test, and plug the current module into multimeter jack and then put the pens into the current module and parallel it to the tested circuit. **Attention:** do not directly plug the pen to multimeter jack or parallel it to the tested circuit.
- While using the pen to test, should put your fingers behind the pen protection.
- In order to avoid the readout-error caused by under voltage for battery reason. If the battery displays not enough, it appears () icon, user should replace the battery or use the external power source immediately.
- Under 36V is safe voltage, avoid electric shock while the test above 36V voltage, please test the pens and connections to check whether the insulation is good.
- While measuring, select correct functions





- If need to switch function, the pens should leave away from the test point.

6.2 Start multimeter

First press  to start the power, and press  to enter the working mode, the default function is the DC voltage measurement.

6.3 Multimeter buttons and their functions

The multimeter functions can be operated by buttons or touching. Instructions are as follows.

Press  then  then   or roll the wheel  to select the relative functions.

Press  to open “relative” function. It refers to the basic value relative to the defined

measurements, if the measured values in excess of the range, the others are not allowed to open the “relative” function.

Press  to re-acquire resample the data, which calculates the measurement value.

Press  the multimeter HOLD button to keep or remove current readout on the screen.

Description of multimeter functions

Multimeter can measure 12 kinds of physical quantities such as voltage, current, resistance, capacitance, temperature, humidity, frequency etc. and also average maximum and minimum value (both with time marks), all measurement processes can automatically adjust the gear. Multimeter interface is shown in picture 6-1.

Multimeter buttons and their functions

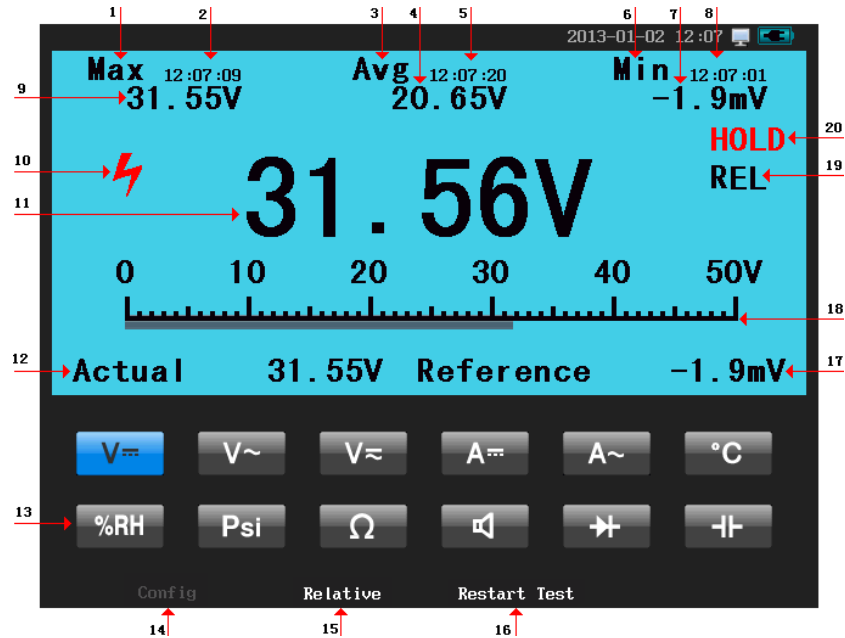

Picture 6-1 Multimeter interface(refer to the diagram)





Description of multimeter interface

1. Maximum icon
2. Maximum record time: show the maximum record time.
3. Average icon
4. Average value: show the average data
5. Average record time: the record time of average operation
6. Minimum icon
7. Minimum: show the minimum data
8. The minimum record time: show the minimum record time.
9. Maximum: show the maximum data
10. High voltage icon: if > 30 V DC or AC, this symbol will appear
11. Current measurement value: the measurement result of current signal
12. Actual value: the actual current measurement value shows when "relative" function is open
13. Function menu area: 12 kinds of physical quantities. More details is shown in the function menu area.
14. Left move function button: left menu selection function.









Multimeter buttons and their functions

15. Right move function button: right menu selection function.
16. Relative function button, for open/close the relative function
17. Restart test function button: re-acquire the data and operation
18. Benchmark: the benchmark samples value, the relative function displays when it starts
19. Range scale: shows the range of current gear, according signal to auto- adjust.
20. Start the relative: the relative displays.
21. the HOLD icon: Press  to start the HOLD function. HOLD is used to display the current data.

Description of function menu

	DC voltage measurement range:1mV~1000V		Relative humidity measurement
	AC voltage measurement range:1mV~750V		Pressure measurement

Multimeter buttons and their functions

	AC/DC voltage measurement range: 1mV~750V		Resistance, range: 0~50MΩ
	DC current measurement		On-off function, <50Ωalarm Max 500Ω
	AC current measurement		Diode.Range: 0~3.5V
	Temperature measurement		Capacitance,Range:100pF~50uF

6.4 Use multimeter

1. Measurement of voltage, resistance, capacitance, frequency, diode, on-off etc. firstly insert the black pen to multimeter COM jack, then the red pen inserts into the V/Ω jack, choose the relative function, then connect the pens to the measured circuit to measure.

2. The current measurement requires an external module or current clamp (optional).

1) Use an external module: first choose the relative function, insert the external module to multimeter jack, and then insert the pens and module, finally connect the pens to the measured circuit to measure; 2) using the current clamp: select the relative function, then directly insert the current clamp to multimeter jack, stuck the measured object then can measure.

3. Measurement of the temperature and humidity requires an external sensor module (optional). First select the relative function, insert the external sensor module to the multimeter jack, and then connect the sensor modules, then can measure. 

Attention: if Voltage is over 30 V, the screen will have a high risk identifier hint, at this time user must pay attention to avoid touch the hazardous voltage circuit, personal safety, and prevent electric shock.



4. A pressure measurement requires an external sensor module (optional). Firstly select the relative function, then insert the external sensor module to multimeter jack, and at last connect to the sensor modules, then can measure.

Chapter Seven Use Recorder

This chapter mainly includes the below contents

- Start recorder
- Record
- Playback

7.1 Start recorder

Press  to turn on the power, and then press  to enter recorder work mode. The recorder mainly includes two functions: recording and playback. Only a part of the function buttons can be used in recorder work mode. The available functions are the same as in the oscilloscope mode, and the available function buttons will be introduced particularly in the below sections.

7.2 Record

The record contains multimeter record, oscilloscope measurement record, oscilloscope waveform record. Each record type internally can store at most two records, and the USB storage device can store two records, but can't store the record to the instrument and the USB storage device simultaneously. After identifying the USB storage device and the records default will be stored in the USB storage device. The oscilloscope cannot delete record





results, but cover the results of last record.



Record store mode can be divided into stop when full and cycle store these two mode.

7.2.1 Multimeter record

Eight kinds of measurements (DC voltage, AC voltage, AC/DC voltage, AC current, DC, Temperature, Humidity, and Pressure) can be recorded, each time you select one of these measurement types, the first selection of DC voltage is the default record and the results will be displayed on the screen as waveform.

Please follow these steps to perform record

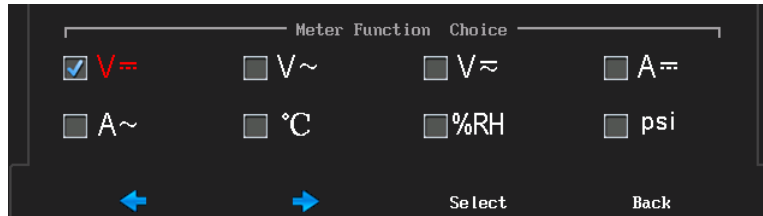

- 1) Successively press   to the recording mode.
- 2) Press  to enter the multimeter record mode.
- 3) Press  to the multimeter record type selection menu.

Description of record type selection: Press on the touch screen to select the record type or use the menu to select the record type. Press **F1** to move left and press **F2** to move right, then press **F3** to confirm choice; Or use   to quick move. The menu of meter function choice is shown in picture 7-1



Picture 7-1 meter function choice



- 4) Press **F4** back to upper menu
- 5) Press the time scale **s ns** to select the required gear.



- 6) Press  to prepare starting the multimeter record
- 7) Press  to start the record and store the data To Record 1, or press  to start the multimeter record and store the data To Record 2.



Description of store recording choice menu: if there is no time shown below the “To Record 1”, then no record and the time below the “To Record 2” is the record time. If add a new record to “To Record 2”, then last record will be replaced.



Picture 7-2 store record menu

Description of available function button: in recording mode, the horizontal time scale adjustment  and on/off menu  are active, the range of the horizontal timescale is 10s—20min, however, once start the recording, horizontal time scale

cannot be adjusted. Press  or press  on the touch screen to stop recording and return to previous menu. Multimeter DC voltage record is shown in picture 7-3.

Notes: Press  to adjust the record time scale and press  to close the menu, and then press  to open the menu, continue for next step.

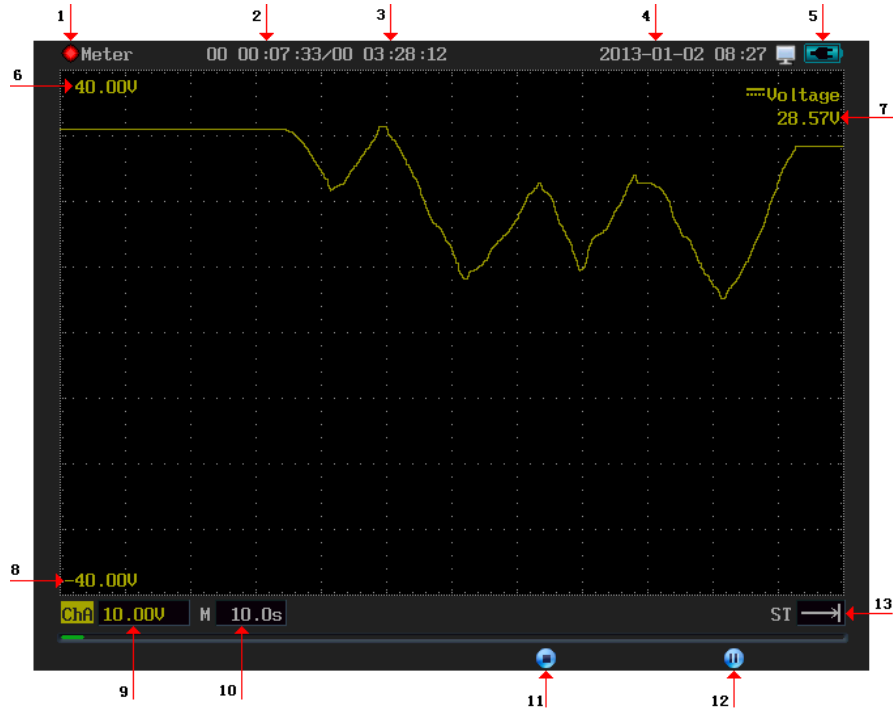



Picture 7-3 multimeter record



Multimeter record interface description

1. Record state: ■ Means stop recording or preview mode ● means record is ongoing.
2. Record time length
3. The total time length of recording
4. Current time
5. Power icon
6. Corresponding value for record interface edge: Accordingly auto-adjust the record value
7. Current record value
8. Corresponding value for under the record interface edge: Accordingly auto-adjust the record value
9. Vertical scale factor: Value on each grid represents the voltage value
10. Horizontal scale (horizontal time-base): Per value is represented by the time value,

using the horizontal time scale  to adjust.

11. Stop recording and back to upper menu

12. Panoramic mode: When the record fills a full screen or more than one screen at a time, press  to open panoramic mode, at this time the recording is still in progress, then repress  to cancel the panorama mode.

13. Storage mode:  Stop when full store  cycle store.

Panorama mode: Before setting the panorama mode, all the recorded data are displayed on the screen, panoramic mode waveform is shown in picture 7-4.

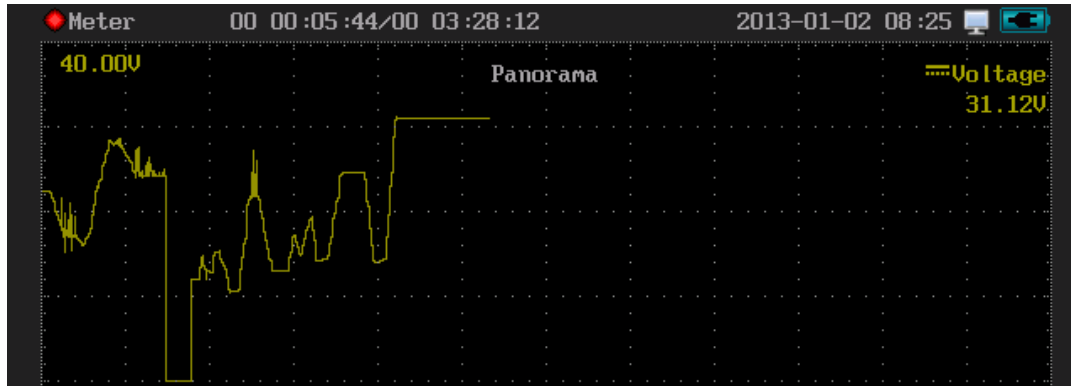







Picture 7-4 Panorama mode

7.2.2 Oscilloscope measurement record

There are 31 types of measurements can be recorded in this instrument. In work mode, users should set voltage, time scale gear, phase, trigger source, trigger type, trigger position, and measurement type selection. Select the record type in the recorder work mode, each time can record two types of measurement at most. If more than two kinds of

measurement types, users need to select the recorder types in work mode, otherwise the default record is the first two records.

Please follow these steps for measurement record

- 1) Press  to enter the oscilloscope and carries on the related settings, make waveform display normally.
- 2) Press  to choose the type of measure, and user can choose at most four types.
- 3) Successively press    to enter the oscilloscope record.
- 4) Press  to select measurement type record, record type as frequency and the rise time. As shown in picture 7-5.

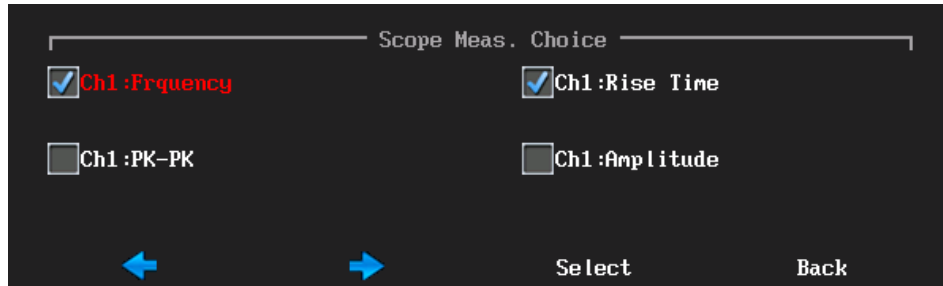

Picture 7-5 measurement record type to choose

- 5) Press **F4** to return to upper menu.
- 6) Press horizontal time scale **s ns** to select required gear.
- 7) Press **F2** to prepare starting the oscilloscope measurement record.
- 8) Press **F1** to start the oscilloscope measurement record and store the data "to record 1" or press **F2** to start the oscilloscope measurement

record and store the data to record 2. Measurement record for oscilloscope frequency and rise time is shown in picture 7-6.

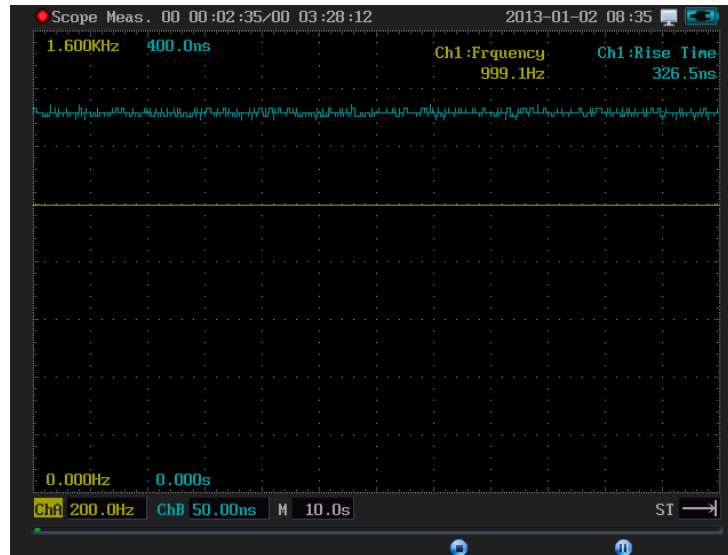

Picture 7-6 oscilloscope measurement record

7.2.3 Oscilloscope waveform record

Oscilloscope waveform can record single channel or dual channels waveform data. Users should set oscilloscope mode, sampling mode, coupling mode phase and then into the recorder mode for recording.

Suggestion: sampling mode set to "peak", when oscilloscope in high sampling rate can capture more signal details.

In recorder mode, you can configure the waveform record start/stop mode; you can set start/stop trigger level. Oscilloscope waveform recording level scale (horizontal time-base) the range of adjustment is 10 ms - 2.0 min.

Each has 7 methods to start/stop, respectively set the start/stop mode.

- Normal: manual start/stop recording
- Ch1 rise edge: with Ch1 rise edge start/stop record
- Ch1 fall edge: with Ch1 fall edge start/stop record

- Ch2 rise edge: with Ch2 rise edge start/stop record
- Ch2 fall edge: with Ch2 fall edge start/stop record
- EXT rise edge: with EXT rise edge start/stop record
- EXT fall edge: With EXT fall edge start/ stop record.





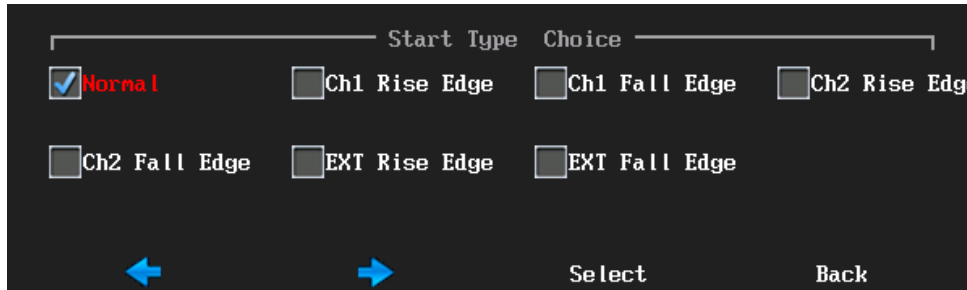



Start type choice as shown in figure 7-7. Stop type choice is the same

Notes: If use start/stop mode to select rise/fall edge, need press **F3** to adjust the start/stop the trigger level.



Picture 7-7 start mode selection

Connect Ch1 to sine waveform, period is 10ms, unconnected Ch2 to the signal. Follow these steps for oscilloscope waveform recording.

- 1) Enter the operation mode and for each configuration to make waveform display normally.
- 2) Successively press    to enter the oscilloscope waveform recording.
- 3) Press  to related configuration.
- 4) Press  to set start mode as normal then press  to set the stop mode as the normal
- 5) Press  to return to upper menu
- 6) Press time scale  to required gear.

- 7) Press **F2** to prepare starting the oscilloscope waveform record.
- 8) Press **F1** to start the oscilloscope waveform recording and storing the data to record 1; Press **F2** to start the oscilloscope waveform to record and store the data to record 2. Waveform record is shown in picture 7-8

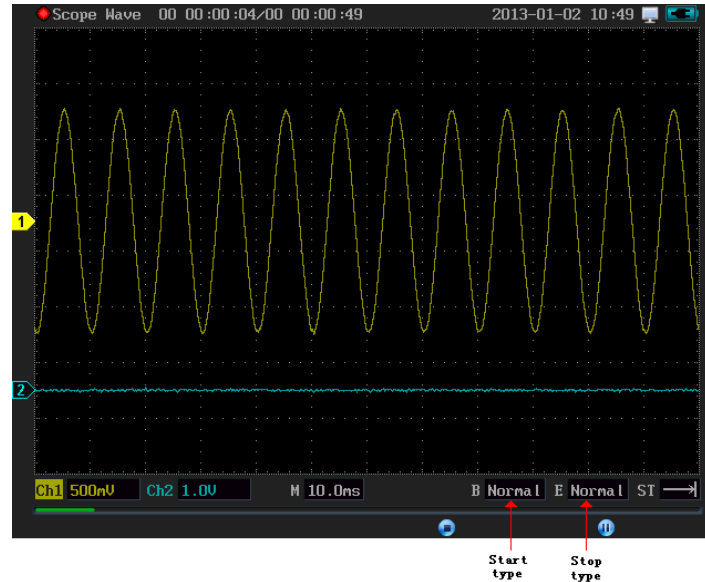





Picture 7-8 Waveform recording

7.2.4 Store mode set

Store mode includes two type: stop when full and cycle store. Stop when full **ST →**,

which means if the internal storage capacity of the oscilloscope or U device are full, the record will stop automatically. Cycle store **ST**  which means if the internal capacities of the oscilloscope or U device are full, will continuously store new record and the old data will be covered.

Following these steps to store set





- 1) Successively press    to enter the store set.
- 2) Press  to select the store mode
- 3) Press  to choose the menu, and then finish the set.

7.3 Playback

Playback contains 1, multimeter record playback, 2, oscilloscope measurement record playback, 3, oscilloscope waveform record playback, 4, the last record playback. After identifying USB storage device, the playback data is the default USB data.

7.3.1 Multimeter record playback

Please follow these steps to use multimeter record playback.

- 1) Press  to enter the recorder-working mode.
- 2) Press  to choice menu and enter the playback type.
- 3) Press  to choose multimeter record playback.
- 4) Press  to choose the playback to record 1 or press  to select the playback to record 2;

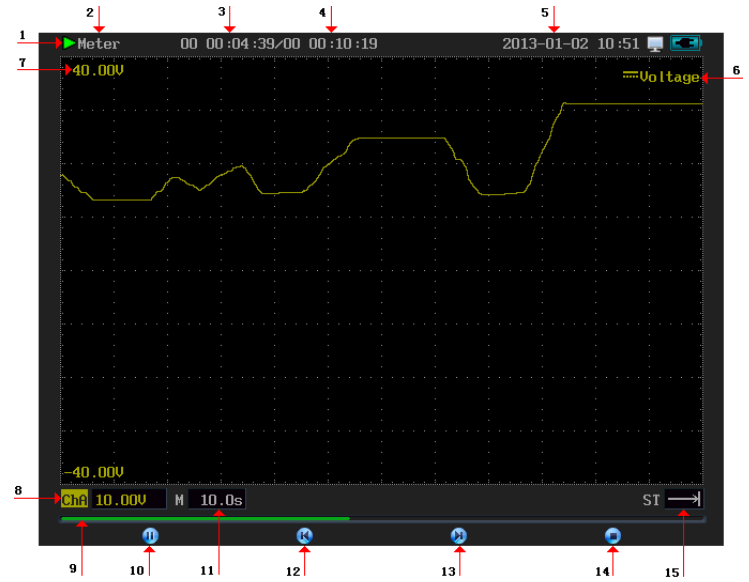

5) Press **F1** to start playback, the playback is shown in picture 7-9.







Picture 7-9 the record playback

Description of the interface of record playback







1. Playback state: ▶ in playback ■ stop playback
2. Playback record types: multimeter record
3. Playback time length
4. The total time length of the record
5. Current time
6. The multimeter record types: eight types of records
7. Corresponding values from the bottom to top edge on the screen.
8. Average vertical scale factor is 10.00V
9. Playback progress bar
10. Playback/stop and press  to switch

11. Horizontal scale (horizontal timescale)
12. Backward
13. Fast forward
14. Stop, press  to stop replay and then press  to return to upper menu.
15. Storage mode

Replay displaying and operating instructions: After selecting replay “record 1”/“record 2” to enter the preview mode then the screen displays waveform data. Press  to play mode. If the record waveform data extend out of one screen then can press  to adjust timescale, if the data less than one screen, user can't adjust timescale. Press  then the waveform will move forward. And press  then the waveform will rewind, and press  and the waveform can quickly movie forward and backward.

7.3.2 Oscilloscope measurement record replay

Follow these steps to replay the oscilloscope measurement record.

- 1) Successively press   to enter the recorder replay mode.
- 2) Press  to select the oscilloscope measurement replay.
- 3) Press  to choose replay mode “record 1” and press  to choose replay mode “record 2”;
- 4) Press  to start replay.



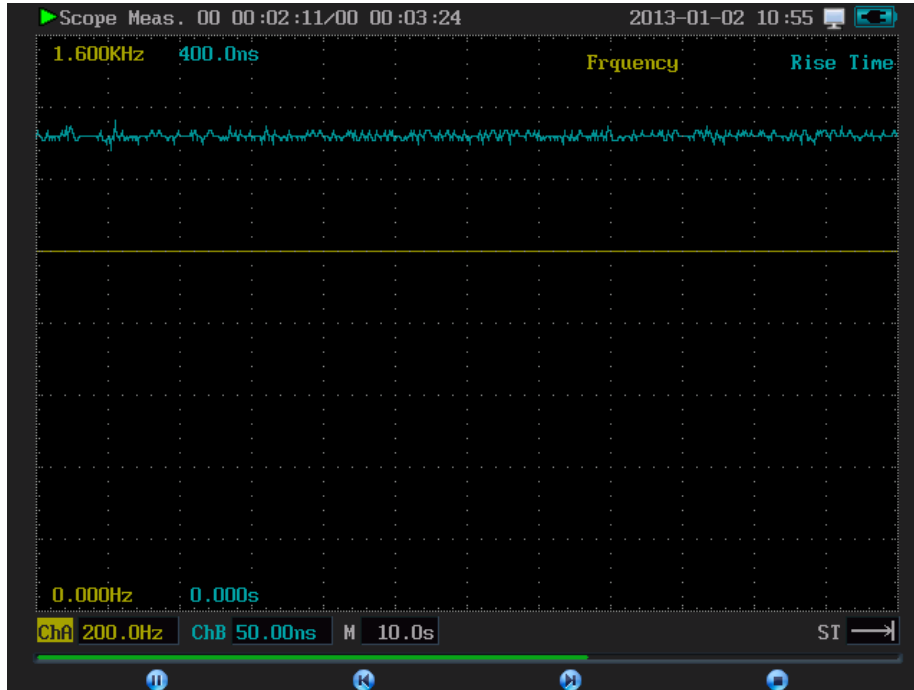



Oscilloscope measurement record replay is shown in picture 7-10.



Picture 7-10 oscilloscope measurement record replays

7.3.3 Oscilloscope waveform replay

Follow these steps to replay oscilloscope waveform recorded.

- 1) Successively press   to enter the recorder replay mode.
- 2) Press  to select the oscilloscope waveform record replay.
- 3) Press  to choose replay mode “record 1” and press  to choose replay mode “record 2”;
- 4) Press  to start replay.

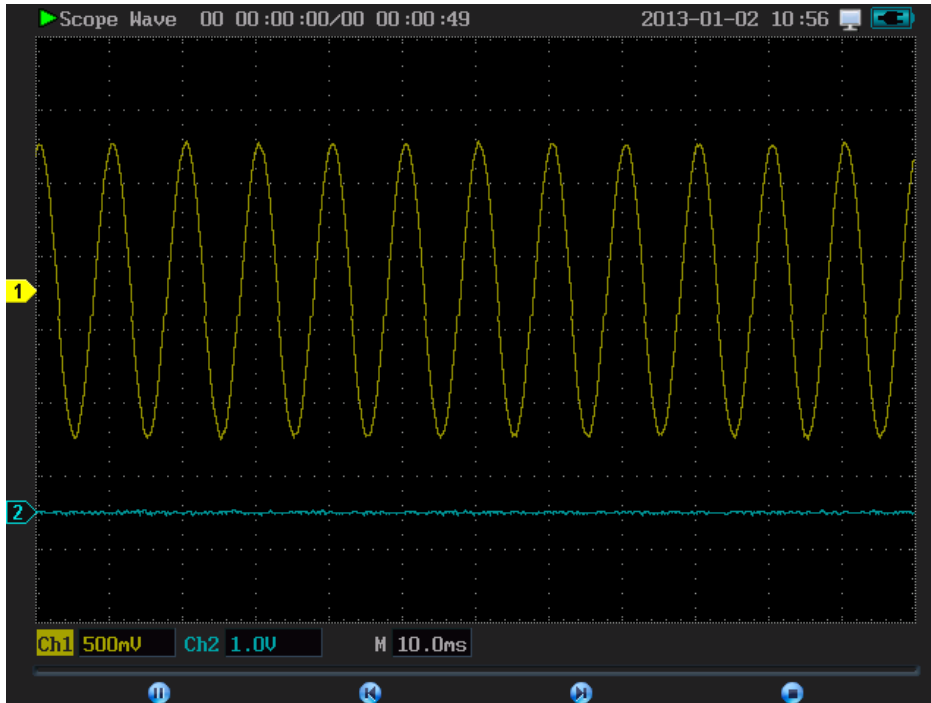

Oscilloscope waveform record replay is shown in picture 7-11.



Picture 7-11 oscilloscope waveform record replays

7.3.4 The last record playback

Please follow these steps to playback the last record

- 1) In record mode, successively press   to enter the last record replay mode.
- 2) Press  to start replaying record for the last record.

Chapter Eight Users' section

Users' section includes system config, tools and help. Press  to enter users' page after starting up. The users interface is shown in Figure 8-1.





Picture 8-1 users interface

The users' section includes: Date time, language, help, touch screen calibrate, tools, factory reset, adjust screen brightness, preference and demo config.

1.Date time







Please follow the steps below to set the system date and time:

- 1) Press  and enter the user page;
- 2) Press "time set" and enter the date and time setting page;
- 3) Set the year, month and day by pressing the number buttons of "0 to 9";
- 4) Press "back" or  to return to the previous menu I. Then the setting is done.

2. Language

Oscilloscope supports two kinds of languages: Chinese and English. Press "language", and then press "simplified Chinese" or "English". Then the system will automatically return to the user page, and update the language.

3. Help

Press "help" to enter the help content table. Under the help content table, there are multi-level directory and hyperlinks which make it convenient for users to look for information. You can get to the corresponding help entries by pressing the underlined character, Press  to change the page; press  to switch the hyperlink item; press  to directly jump to the current hyperlink; press the "back" or press  to return to the previous help entry; press  to return to the previous hyperlink and press  to go move to the next one.

4. Touch Screen Calibration

Press the key  to enter the user page. Press the "touch screen calibrate" to enter the touch screen calibrate mode. Press the icon according to the screen prompts (press on the cross icon of calibration), until it said "finish". Press "finish" to end screen calibration and it will automatically return to the users' page. Calibration icon is shown in Figure 8-2 and the finish page of calibration is shown in figure 8-3.



Picture 8-2 calibration icon

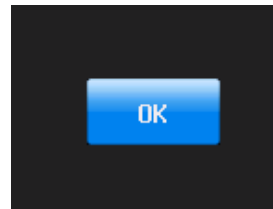

Picture 8-3 finishes the calibration of the page

5. Tools

The tools contain two calculation tools: a scientific calculator and an electronic calculator.

(1) The scientific calculator

Press on the touch screen to import numbers and calculator and get the calculated results.

Taking calculate expression $(3 + 9) * 8$ as an example. Please follow the steps below:

- 1) Press hex to select the decimal system;
- 2) Press formula to select formula calculation;
- 3) Input the formula by clicking "(", "3", "+", "9", ")", "*", and "8" successively;
- 4) Press "=" to get the calculated result: 96;
- 5) Press "back" or  to return to the tools page.

The interface of scientific calculator is shown in figure 8-4.



Picture 8-4 calculator

(2) Electronic Calculator

The electronic calculator is for calculating of inductive reactance, capacitive impedance, and parallel resistance and LC resonant frequency. Take the calculation of inductive reactance value as an example. Please follow the steps below:

- 1) Press  to enter the users' page;
- 2) Successively press the tool and the electronic calculator;
- 3) Press inductive reactance;
- 4) Press frequency;
- 5) Input the value of frequency in the input area;
- 6) Press "inductance";
- 7) Input the value of inductance in the input area;
- 8) Press "=" in the input area and the result will be displayed in the display area for the inductive reactance value. The interface of electronic calculator is shown in figure 8-6

Instructions for the interface of electronic calculator:

1. Selecting calculation type area, as is shown in figure 8-5 with arrow 1
2. Value input area, as is shown in figure 8-5 with arrow 2
3. Units choice area, as is shown in figure 8-5 with arrow 3
4. Value display area, as is shown in figure 8-5 with arrow 4

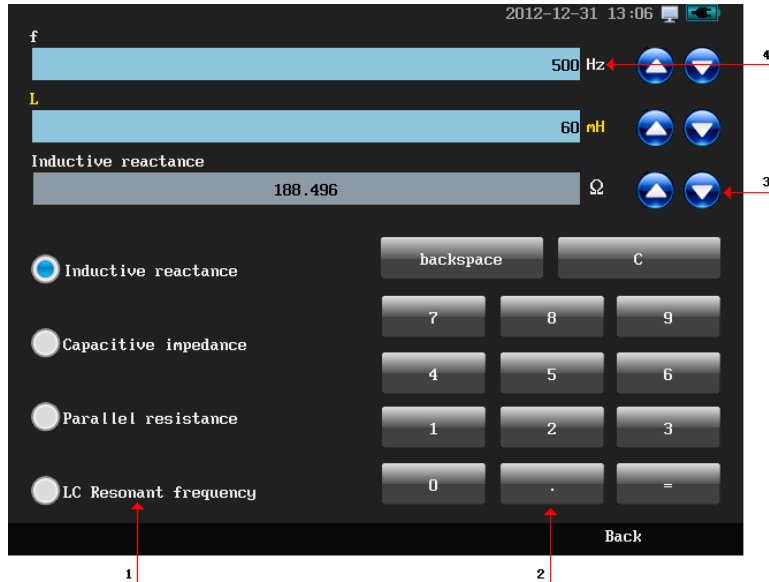

Picture 8-5 the interface of electronic calculator

6. Factory Reset

Press  to enter the user page. Press "load factory settings" and the dialog box for load

factory settings will pop-up. Press "yes" and the confirming box will pop-up. Press "yes" again and load to factory settings. Factory settings could be seen in Appendix C. The dialog box for load factory settings and confirm box are shown in Figure 8-6 and figure 8-7.

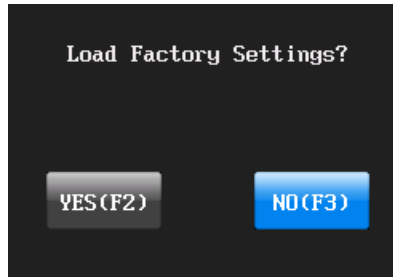



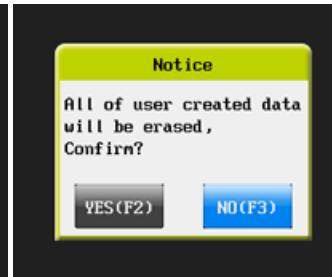

Picture 8-6 load factor set



Picture 8-7 confirm box to empty store

⚠ Warning: after loading factory settings the users can store waveform, the recorded data and other information will be erased

7. Adjust Screen Brightness

Press  to enter the user page. Press "Adjust Screen Brightness" to set the screen brightness. Press the horizontal bar of brightness or roll the wheel or press   to adjust the screen brightness. Press the "back" or  back to the users homepage. The adjustment of screen brightness is shown in figure 8-8

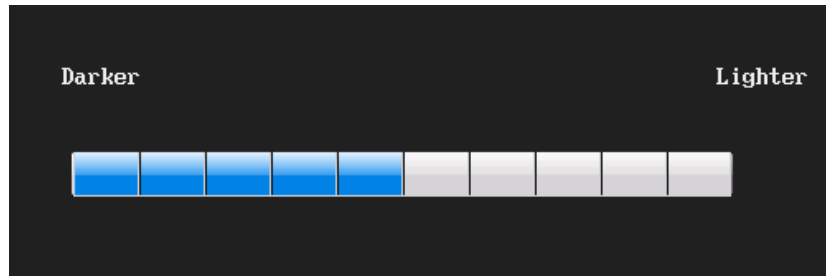

Picture 8-8 adjustment of brightness

8. Preference

Press  to enter the users' page. Press "Preference" to enter the preference set. The preference set includes:

- 1) Menu hide time set: the menu auto-hide time, max. 60 seconds.
- 2) Standby time set: interval between the last operation and the oscilloscope enters into the standby state with the max 60 minutes.
- 3) Shut down time set: the interval time between the last operation and the oscilloscope entering the shutdown state with a maximum of 60 minutes.
- 4) Wheel direction set: the upward or downward movements for cursor trigger level and wave in vertical position are corresponding to the direction of the wheel.
- 5) Keypad tone set: turn on or off the button tone.

Preference set is shown in figure 8-9.

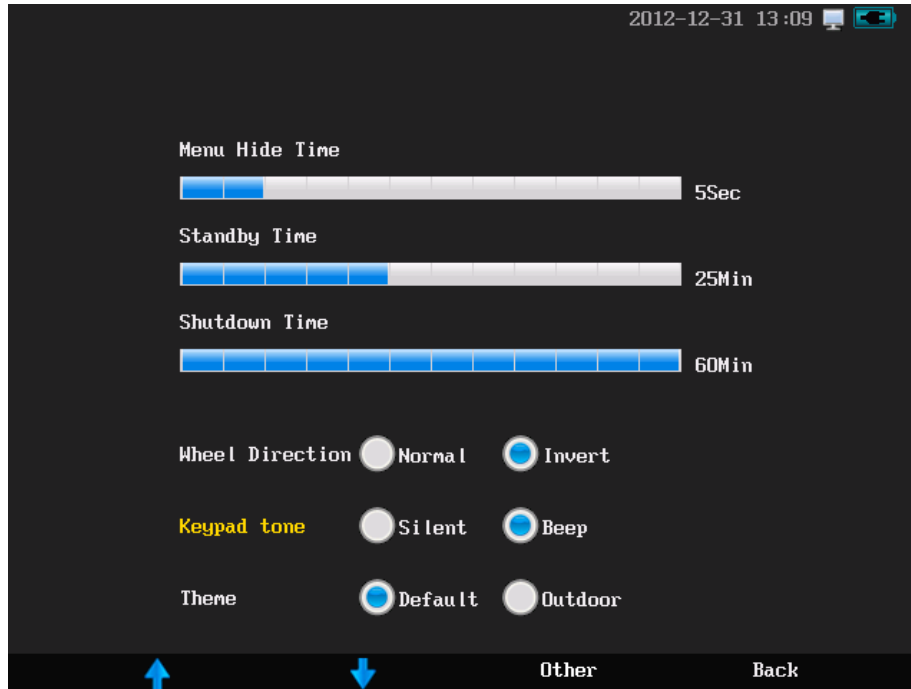

Picture 8-9 preference set

Chapter Nine ScopeSuite Software

Micsig ScopeSuite is the support software for handheld multifunctional oscilloscope based on the Window platform. Through this software, the user can connect his personal computer to the oscilloscope to enhance function and make the using of oscilloscope more flexibly. ScopeSuite software can realize these functions: screen shot and record, remote control, display and record of real-time waveform and measurement value, oscilloscope /USB storage device data export, analysis of some data, information retrieval, firmware upgrades and other enhancements. Through these functions, it can realize the higher requirements of users for data measurement and analysis.

Standard Micsig ScopeSuite software only contains the basic functions, such as upgrade oscilloscope firmware. Other functions of the ScopeSuite software are optional.

For more instructions about ScopeSuite software, please refer to the PDF of our Scope Suite software instructions.

Chapter Ten Troubleshooting

Troubleshooting

1) If the oscilloscope does not start up at power on, please follow steps below:

- Check the power cord to verify it has been connected properly.
- Check the power on/off buttons to ensure it has been pushed. if you are using the battery, check whether the battery on good condition.
- Restart the oscilloscope.
- Contact Micsig if the problem persists.

2) If waveforms will not display when the oscilloscope is switched ON, please follow the steps below:

- Check whether the probe is connected correctly in the BNC socket
- Check whether the probe is connected correctly in the input signal
- Check whether signal source is working properly
- Check whether the channel switch (such as CH1, CH2 menu buttons) is turned on

- Check whether the vertical scale factor is set correctly
- Check whether trigger source, trigger conditions are set correctly
- Check whether the instruments are in waiting state for trigger
- Press  to resample signal

3) If the measured voltage amplitude is 10 times greater or 10 times smaller than the practical value:

- Check whether the settled attenuation factor of the channel is in accordance with the attenuation factor of the used probe.

4) If the waveform is moving continuously on the screen and cannot be triggered:

- Check the trigger source to ensure that it is consistent with the input channel.
- Check the trigger type: edge trigger for general signal; video trigger mode for video signal. Only use the correct trigger mode, could display stable waveform.

- Check the noisy signal source. Set the trigger coupling mode to high-frequency inhibition or low-frequency rejection to filter out high frequency or low frequency interference
- Check whether the trigger hold-off time is appropriate

5) If there is no any display after pressing :

- Check whether the triggering mode is 'normal', and whether the trigger level is beyond the scope of the waveform. Center the trigger level and set the trigger mode as auto
- check whether the time is too long for level delay
- Test whether the trigger hold-off time is too long

6) If the display becomes slow down after setting average times of sampling:

- If the average times are above 32, it is normal for the general speed.
- You can reduce the average times

Chapter Eleven Services and Support

Service Commitments

Micsig promises that all products are manufactured and tested according to national standards or enterprise standards. Micsig promises no unqualified products will leave our factory. First-class customer services are provided for all sold products. The warranty periods for products are 3 years since date of shipment, and 90 days for the sold spare parts and maintenance. For the details of warranty service, please read the chapter of "scope of limited warranty and service". Micsig provides lifetime repair and maintenance services for products. In accordance with the relevant provisions of after-sale service of industrial products and the enterprise's own capacities, our commitments are as follows:

Repair commitments: Micsig commits to users that the original factory parts on the returned (warranty repair or repair) and their debugging and testing standards are identical with new products. For non-defective products and products with decreased performance

out of objective causes, we have the obligation to inform the customer, but without any other duties

Service time limits commitments: Reply the time and cost for repair within 2 working days after receiving the returned product. Repair cost will be informed for products need repaired and Repair time for common problems is 5 working days after the confirmation of the replay and for special fault repair, the period is not more than 10 working days.

Spare parts providing commitments: Micsig has established a perfect store for spare parts to provide long-term (at least ten years) supply of spare parts and technical support for products.

Contact us

Shenzhen Micsig Instruments Co., Ltd

Direct: +86-755-88600880

Web: www.micsig.com

Email: sales@micsig.com

Appendix

Appendix A: Technical specifications

To comply with the technical specifications, must meet two conditions.

1. The oscilloscope must have undergone a half an hour warm-up period under the specific operating temperature;
2. The 'Do Self Cal' operation must be performed through the Utility menu if the operating temperature changes by more than 5°C.

All specifications are guaranteed unless noted 'typical'.

General technical specification

Type—bandwidth	MS310IT, MS510IT, MS510S—100MHz MS320IT, MS520IT, MS520S—200MHz
Isolated voltage between Channel.	CAT II 1000V CAT III 600V
BNC refer to ground floating voltage	CAT II 1000V CAT III 600V
BNC input the maximum voltage	CAT II 600V CAT III 300V
Number of channel	Two oscilloscope channels, one multi-meter channel
Shell	

Technical specification

Design	Dual color injection protection shell design, high intensity, impact resistant
Display	
Screen	5.7 inch TFT touch LCD
Resolution coefficient display	640*480
Color display	64K color
Background light intensity (typical)	200/m ² -500 cd /m ²
Communication	
Communication interface	USB Host connect to USB storage device, USB storage device connect to PC
Power	
Adapter input	100 to 240V AC, 50/60Hz
Adapter output	12V DC, 5A

Technical specification

Battery	Standard Li-battery capacity	7.4V/6000mAh
	Duration of working time (typical)	4.5H
	Power off charging time (typical)	4H
	Optional Li-battery capacity	7.4V/9000mAh
	Duration of working time (typical)	7H
	Power off charging time (typical)	6H
Environment		
Temperature (work/storage)	-20°C~+50°C / -20°C~+60°C	
LCD panel temperature (work/storage)	-20°C~+70°C / -30°C~+80°C	
Humidity (work/storage)	< 75%RH / 85%RH (+30°C~+40°C)	
Altitude (work/storage)	Max 3000m / 12000m	
Cooling method	Natural convection	
Mechanical		
Size (length*width*depth)	254mm*160mm*60mm	

Technical specification

Weight	Oscilloscope (no battery)	1380g
	Standard accessories (typical)	691g
	Standard battery (typical)	276g
	High capacity battery (typical)	381g

Oscilloscope

Max. sample rate		Single channel 1GS/s, dual channel 500MS/s
Max. memory depth		Single channel 240K dual channel 120K
Bandwidth limitation		20MHz (-3dB)
Sampling configuration		Normal, peak-peak value, envelope, average
Single Sequence	Normal, peak-peak	For a sampling, all channels work simultaneously
	Average, envelope	For N times of sampling, all channels work simultaneously. N is set from 2 to 256 (corresponding envelope is ∞)
Output voltage of probe compensation (typical)		$\geq 1\text{M}\Omega$ while loading, peak-peak value is 2V

Technical specification

Frequency of probe compensation (typical)	1KHz, square wave
Interpolation method	Sin(x)/x
Input	
Input coupling	DC, AC, Ground Connection
Input resistance	1MΩ±1% 15pF±3pF parallel connection
Probes attenuation factor	1mX~1KX,step by step as the way of 1、2、5
Horizontal	
Position range	±6grid
Horizontal timescale	4ns/div~10s/div press 1~2~4 step by step
Timescale(delay) position adjusting range	-12grid~50s
Timescale accuracy (typical)	±20ppm
Verticality	
Vertical scale	5mv/div~50v/div , step by step as the way of 1~2~5
Adjustment of position scope	±4 grid

Technical specification

Vertical resolution		8 bit
Rising time (typical)		100MHz ≤3.5ns
		200MHz ≤1.75ns
DC gain accuracy (typical)		5mv/div~50v/div, ±2.0%
DC measurement precision (typical)		5mv/div~50v/div, ±(2.0%×actual readout + 0.04×vertical displacement/div)
Trigger		
Trigger source		Ch1, Ch2, EXT
Trigger mode		Automatic, normal, single sequence
Type	Edge triggered	Rise edge, fall edge, dual edge
	Trigger pulse width	Conditions: <, >, =, ≠ Polarity: positive, negative
	Logic trigger	Logical calculation: AND, OR, NAND, NOR
	Video trigger	Format: 625/PAL, SECAM, 525/NTSC, 720P, 1080I, 1080P Type: odd, even, all, all line, assigned line

Technical specification

Serial bus trigger	UART (RS232/RS422/RS485)	Pattern: parity error, [X: data], [0: data], [1: data], data, stop bit, start bit
	LIN	Pattern: frame ID and data, frame ID, sync –rising edge
	CAN	Method: start frame, remote frame ID, frame ID data, remote frame, data frame ID, data ID and data, error frame, all error, Ack error, overload frame
	SPI	Pattern: match the binary data
	I2C	Pattern: start condition, stop condition, Ack lost, block address field no Ack, restart, EEPROM data read, frame type 1, frame type 2
Serial bus decode	MS300 Series (5 types)	UART/RS232/RS422/RS485, LIN, CAN, SPI, I2C
	MS300 Series (7 types)	UART/RS232/RS422/RS485, LIN, CAN, SPI, I2C, ARINC429, MIL-STD-1553B
Trigger coupling mode		DC, AC, HF rejection /LF rejection and Noise rejection
Trigger rejection time range		200ns~10s

Technical specification

Measurement	
Measurement type	Period, Frequency, Rise time, Fall time, P Duty cycle, N Duty cycle, Delay, P Pulse width, N Pulse width, P Overshoot, N Overshoot, Phase, Peak-Peak, Amplitude, High, Low, Max ,Min, Average, Cycle average, RMS, RMS cycle
Cursor type	Horizontal cursor, Vertical cursor, Crossing cursor
Dynamic recording(U device connected)	
Time	Max 2h
Replay of forward/backward	Support
Record the total frames	Support
Replay frames/display frames	Support
Math	
FFT	Rectangular, hanning, hamming, BlackmanHarris
Dual waveform	+, -, *, /
XY model	

Technical specification

X- axis input/ Y-axis output	Ch1 / Ch2
Storage	
Waveform	Four sets of stored waveforms and can be stored in external U devices.
Screenshot	Support(U device or PC connected)
User settings	Nine choices
Display	
Refresh mode	Normal refresh, High refresh
Max refresh rate	MS500 series 190k wfm /s MS300 series 50k wfm/s
Afterglow	Automatic , 100ms~10s, ∞
Waveform display area	8 × 12 grid
Waveform drawing mode	Dot, line
Languages	Simplified Chinese, English, Russian

Technical specification

Probe (Below is the example of MC probe. Take the probe instructions as the priority)

Working voltage	CAT III 600V
Attenuation coefficient	10:1
Input capacitance	13pF
Match range	10pF~30pF
Input impedance	10MΩ±1%
Bandwidth	DC~250MHz
Rise time	1ns
Cable length	1200mm

Multimeter

Full scale reading	5,000 counts	
DC voltage (+28°C)	Range: 1mV~1000V	Range: 1mV~60mV accuracy: $\pm 1.5\% \pm 10$ counts
DC voltage (+28°C)	(MS200 series)	Range: 60mV~1000V accuracy: $\pm 1.5\% \pm 5$ counts
	Range: 1mV~1000V	Range: 1mV~60mV accuracy: $\pm 0.5\%$

Technical specification

	(MS300, MS500 series)	Range: 60mV~1000V accuracy: $\pm 0.5\%$
AC voltage (+28°C)	Range: 1mV~700V frequency range : 10.0Hz~20.000KHz	Range: 1mV~60mV accuracy: $\pm 1\% \pm 10$ counts Range: 60mV~700V accuracy: $\pm 1\% \pm 5$ counts
Ac/dc voltage(+28°C)	Range: 1mV~700V	Range: 1mV~50mV accuracy: $\pm 1\% \pm 10$ counts Range: 50mV~700V accuracy: $\pm 1\% \pm 5$ counts
DC current		Optional modules or current clamp, can be customized
AC current		Optional modules or current clamp, can be customized
Resistance	Range: 0~10M Ω	Accuracy: $\pm 1\%$ (+28°C)
	Range: 10M Ω ~20M Ω	Accuracy: $\pm 3\%$ (+28°C)
On-off test		If <50 Ω , system will alarm Max 500 Ω
Diode		Range: Max 3.5V

Technical specification

Capacitor	Range: 100pF~5uF	Accuracy: $\pm 5\%$ (+28°C)
	Range: 5uF~50uF	Accuracy: $\pm 10\%$ (+28°C)
Temperature		Optional sensor module, can be customized
Humidity		Optional sensor module, can be customized
Pressure		Optional sensor module, can be customized
Measurement Display		Max, Average, Min in total, all with a time tag. Relative measurement

Recorder

Record content		Measurements for multimeter, oscilloscope and oscilloscope waveform
Display mode		Panorama screen、normal
Record time scale	Multimeter	10s/div~20min/div
	Oscilloscope	10s/div~20min/div

Technical specification

	Oscilloscope waveform	10us/div~2min/div (Connect USB storage device)
Max. recording time		No limit (Connect USB storage device)
Replay forward/backward		Support
Storage mode		Stop when full, cycle storage
Data save mode		Interior, USB storage device
Time display		Record time: support Replay time: support

Appendix B: Maintenance of oscilloscope

General maintenance

Do not put or leave the device in a place where the LCD display will be exposed to direct sunlight for long period.



attention: To avoid damage to the oscilloscope or probes, do not expose them to sprays, liquids, or solvents.

Clean oscilloscope

Maintenance of oscilloscope

Examine the oscilloscope and probes as often as operating conditions require. To clean the exterior surface, perform the following steps:

- Use a lint-free cloth to remove floating dust on the outside of the oscilloscope and probes. Take care to avoid scratching the glabrous display filter.
- Use a soft cloth dampened with water to clean the oscilloscope while doing this please keep the power off. Do not use any chemical or corrosive cleaning agent, in order to avoid damaging the oscilloscope or probe.

Store oscilloscope

The battery needs to be full charged before store the oscilloscope



Warning

Make sure the instrument is dry before recharging, to avoid electrical short circuit or injury which caused by moisture.

Battery charge

Turning on the oscilloscope for the first time, it must be charging for more than six hours(for saving the charging time, please turn off the oscilloscope).while using battery power, the top of the screen will display a battery indicator,

Maintenance of oscilloscope

possible battery symbol like: /////; while  is flashing, it says only 10 minutes remained.



attention: avoid charging battery from overheating, do not use beyond the range of environment permit.

Appendix C: Factory default

The following table lists the states of factory resetting or default settings.

Category	Factory resetting (user interface)	Default settings (store/restore menu)
Sampling		
Coupling	DC	Factory default
Mode	Normal	Factory default
Mean counts	16	Factory default
Envelope counts	16	Factory default
Bandwidth	Full bandwidth	Factory default
Delay	On	Factory default
Phase invert	Off	Factory default
Probe coefficient	1X	Factory default

Factory default

Select channel	Ch1—>Open and default as current channel Ch2—>open	Factory default
Run/stop	Run	Factory default
Sampling single sequence	Stop	Factory default
Vertical position	Middle of screen	Factory default
Vertical scale	5mV	Factory default
Time scale	1.00ms	Factory default
Trigger position readout	0.000ms	Factory default
Trigger position indicator	Middle	Factory default
Trigger level	0.000V	Factory default
Current trigger channel	Ch1	Factory default
Cursor		
Cursor function	Off	Factory default

Factory default

After opening cursor, F4 current state	Cursor	Factory default	
Cursor position level 1	+2.0 from horizontal center	Factory default	
Cursor position level 2	-2.0 from horizontal center	Factory default	
Vertical cursor position1	-3.0 from the vertical center	Factory default	
Vertical cursor position2	+3.0 from the vertical center	Factory default	
Cursor track	Off	Factory default	
Measurement			
Measurement strobe	Off	Factory default	
Delay		First rise edge (current channel)	Factory default
	Relative	Ch1	Factory default
		First rise edge	Factory default
Phase	Relative to Ch1 (current channel)	Factory default	
Display			
Waveform drawing mode	Line	Factory default	

Factory default

Waveform brightness	60%	Factory default
Graticule type	Full	Factory default
Graticule intensity	50%	Factory default
Afterglow time	Auto	Factory default
Time scale	YT	Factory default
Refresh rate	Normal	Factory default
Mathematic		
Mathematical channels	Close	Factory default
Mathematical type	Dual waveform	Factory default
Source 1	Ch1	Factory default
Operator	+	Factory default
Source 2	Ch2	Factory default
Trigger		
Trigger type	Edge	Factory default

Factory default

Trigger coupling type		DC	Factory default
Trigger mode		Auto	Factory default
Trigger hold-off time		200ns	Factory default
Edge trigger	Source	Ch1	Factory default
	Slope	Rise edge	Factory default
Pulse width	Source	Ch1	Factory default
	Polarity	Positive	Factory default
	Condition	≠1.000ms	Factory default
Logic trigger	Ch1 logic	High	Factory default
	Level(Ch1)	0.000 V	Factory default
	Ch2 logic	High	Factory default
	Level(Ch2)	0.000 V	Factory default
	Logical Operator	AND	Factory default
	Condition	Switch to true value	Factory default

Factory default

Video trigger		Source	Ch1	Factory default
		Polarity	Positive	Factory default
		Standard	625/PAL	Factory default
		High-definition field	50Hz	Factory default
		Trigger on	Odd field	Factory default
Serial Bus trigger	UART(RS232/ RS422/ RS485)	Bus configuration	Rx is Ch1, Idle level is High Baud rate is 19.2 KB/s, Parity is none, data bits is 8 bit	Factory default
		Trigger mode	Start bit	Factory default
	LIN	Bus configuration	Source is Ch1, Idle level is High Baud rate is 19.2 KB/s	Factory default
		Trigger mode	Sync- rise edge	Factory default
	CAN	Bus configuration	Source is Ch1, Idle level is High Baud rate –is 500 KB/s	Factory default

Factory default

		Trigger mode	Start frame	Factory default
	SPI	Bus configuration	CLK is Ch1, Data is Ch1, and work mode is SCK low idle state, data bits are 8 bit.	Factory default
		Trigger mode	XXXX XXX1	Factory default
	I2C	Bus configuration	SDA is Ch1, SCL is Ch2	Factory default
		Trigger mode	Start condition	Factory default
Reference waveform				
Reference waveform			Off	Factory default
Reference waveform record data			Erase	-
Storage/Recovery				
Memory depth			120.0k	Factory default
User setting storage area			Erase	-
Multimeter				

Factory default

Multimeter measurement type	DC voltage	-
Relative	Off	-
Recorder		
Multimeter record type	DC voltage	-
Oscilloscope measurement type	/	-
Oscilloscope waveform record start mode	Normal	-
Oscilloscope waveform record stop mode	Normal	-
Storage mode	Stop when full	-
Recorder storage area	Erase	-
User		
Time	hold	-
Language	English	-
Help	Homepage	-
Calculator	Decimal, angle, normal	-

Factory default

Electronic calculator	Inductive reactance	-	
Screen brightness	50%	-	
Set	Hidden time	5s	-
	Standby time	15 minutes	-
	Automatic shutdown time	20 minutes	-
	Wheel direction	Normal	-
	Buttons beeper	Silence	-

Appendix D: Attachment

Standard accessories

1. Probe, 2pc, bandwidth depend on model
2. Multimeter test pens, 1 pair
3. Calibration banana jack, 1 pair(MS300, MS500 series. MS 200 without)
4. Power adapter, 1 pc
5. Power cord, 1 pc (suitable for customer local)
6. Removable Li-ion Battery (7.4V6000mAh), 1 pc
7. MiniUSB data cable, 1 pc
8. Quick Start, 1pc
9. Calibration Certificate, 1pc
10. Packing List, 1pc
11. CD

Optional accessories

1. Oscilloscope suitcase
2. Oscilloscope handbag
3. High-capacity battery (9000mAh)

Index

A

Analysis of signal detail, 171
Appendix, 263
Attenuation factor, 51
Afterglow, 75
Attention, 3
Auto measurement, 53
Auto set, 100

B

Button, 16
Button beep, 227
Bandwidth selection, 47
Bandwidth, 240
Blank screen, 232
Banana head, 33
Bracket, 11

C

Capture status, 23
Correct compensation, 35
Capture single pulse signal, 168
CAN graphical interface, 140
CAN bus trigger and decode, 135
CAN text interface, 142
Calibration touch screen, 220
Charging battery, 253
Cursor measurement, 68
Characteristic, 1
Channel, 40
Channel coupling, 41
Channel polarity, 50

D

Dynamic record, 62

Display replay and operating instructions,
209

Dual waveform, 101

Delay, 48

E

Edge trigger, 81

Environment, 242

Electronic calculator, 223

External trigger, 83

F

FFT, 104

Function test, 30

Fault handling, 232

G

Graticule, 73

H

Help, 218

Hide time menu, 227

Hamming, 105

Hanning, 105

Horizontal cursor, 68

Horizontal position, 99

I

I2C graphical interface, 157

I2C bus trigger and decode, 152

I2C text interface, 159

Install and replace battery, 12

Insufficient compensation, 35

L

LIN interface, 132

LIN bus trigger and decode, 129

Logic trigger, 88

LIN text interface, 134

Limited warranty, 2

Language, 218

M

Machinery specification, 242

ScopeSuite, 230

Math menu, 101

Multimeter security consideration, 181

Multimeter button, 182

Multimeter function, 183

Multimeter interface, 184

Multimeter record, 191

Maintenance, 251

Measure simple signal

O

Over compensation, 35

Optional, 227

Open recorder, 191

Open oscilloscope, 20

Open multimeter, 182

Oscilloscope user interface, 21

Oscilloscope measurement record, 198

Oscilloscope waveform record, 201

P

Pen jack, 7

Part name, 7

Power jack, 8

Pulse width trigger, 85

Panoramic mode, 197

Probe compensation, 32

Probe socket, 7

Preface, 4

Panoramic mode, 197

R

Reference waveform, 58

Reference channel, 107

Restore settings, 67

Restore factory settings, 225

Recording interface, 64

Rectangular window, 104

Refresh rate, 78

Run/stop key, 105

Replay interface, 66

Replay, 206

S

Security term, 3

Security consideration, 2

Sampling configuration, 44

Store/restore, 58

Store set, 67

Serial bus decode, 116

Storage mode set, 205

Single sequence, 106

Standby time, 227

Service and support, 235

Shut down time, 227

Scientific calculator, 221

Screen brightness, 226

Screen shot, 67

SPI bus trigger and decode, 145

Slope, 81

Self-calibration, 53

Store depth

T

Touch screen function, 27

Trigger, 79

Trigger level, 79

Trigger coupling, 80

Trigger mode, 80

Trigger rejection time, 81

Technical specification, 240

Turn on, 20

Timescale level, 97

Time set, 217

U

UART (RS232/RS422/RS485) bus trigger
and decoding, 118

UARTtrigger, 122

UARTgraphic interface, 126

UART text interface, 128

Use multimeter, 187

User, 216

V

Vertical cursor, 68

Vertical scale factor, 96

Vertical position, 96

Video trigger, 92

W

Waveform set, 71

Wheel, 9

Warning, 3

Wheel direction, 227

X

XY, 76

Y

YT, 77

Z

Zoom touch screen, 111

If there is any modification of this manual, apologize for no special notice to customer.

The manual contents are believed to be correct, if users find any errors, omissions, etc, please contact us.

We take no responsibility for accident or harm which caused by user error -operating.

All the manual copyright authorization belongs to Micsig, Any organization or individual without our company authorization, shall not copy, redistribute or excerpt the contents.

Contact us

Thank you for your support! To obtain service, warranty or technical help, pls contact us by the following information.

Micsig

Shenzhen Micsig Instruments Co., Ltd.

——— **Tablet Oscilloscope Innovator** ———

Tel: +86-755-88600880

Fax: +86-755-88600880-818

Web: www.micsig.com

Email: sales@micsig.com

Micsig is the trademark and name of **Shenzhen Micsig Instruments Co., Ltd.**

Product information subject to change without notice, please visit our official website

www.micsig.com to get the latest information.

25 Mar 2015