

Multimetrix®

DM 100

Télémètre Laser
Laser Distance Meter
Laser-Entfernungsmesser
Telemetro Laser
Telémetro Láser

Notice de fonctionnement
User's manual
Bedienungsanleitung
Libretto di funzionamento
Manual de instrucciones



Multimetrix®

Groupe CHAUVIN ARNOUX

190, rue Championnet

F - 75018 - PARIS

Tél. 33 (0)1.44.85.44.85 - Fax 33 (0)1.46.27.73.89

692988A00 - Ed. 2 – 05/14

Table des matières

1. Instructions de sécurité	3
2. Mise en service	4
3. Opérations de configuration initiale	6
4. Mesures	7
5. Fonctions	8
6. Spécifications techniques	12
7. Problèmes de fonctionnement	13
8. Conditions de mesure	14
9. Etiquette de sécurité	15
10. Vérification	15
11. Garantie	16
12. Etat de livraison	16



ATTENTION
RAYONNEMENT LASER
NE PAS REGARDER DANS LE FAISCEAU
APPAREIL A LASER DE CLASSE 2

Vous venez d'acquérir un **Télémètre Laser DM 100** et nous vous remercions de votre confiance.

Pour obtenir le meilleur service de votre appareil :

- **lisez** attentivement cette notice de fonctionnement,
- **respectez** les précautions d'emploi.

Le **Télémètre Laser DM 100** est un instrument de précision destiné à la mesure de distances ou longueurs avec possibilités de calcul des surfaces ou des volumes.

1. Instructions de sécurité

Signification des symboles utilisés



ATTENTION, risque de DANGER ! L'opérateur s'engage à consulter la présente notice à chaque fois que ce symbole de danger est rencontré.



Rayonnements laser, ne pas regarder directement dans le faisceau LASER.



La poubelle barrée signifie que, dans l'Union Européenne, le produit doit faire l'objet d'un tri sélectif des déchets pour le recyclage des matériels électriques et électroniques conformément à la directive DEEE 2002/96/EC.



Ce marquage garantit la conformité aux directives européennes « Basse Tension » et « Compatibilité Électromagnétique » (73/23/CEE et 89/336/CEE).

Précautions d'emploi

La présente notice doit être consultée pour chaque symbole de risque de danger rencontré. Pour éviter des rayonnements laser, une blessure ou un dommage à cet appareil, et s'assurer que vous utilisez le télémètre sans risque, suivez les conseils de sécurité ci-dessous :



Ne pas regarder directement dans le faisceau laser. Ne pas diriger le faisceau laser vers des personnes.



Ne pas utiliser l'appareil en dehors de son domaine d'utilisation, ne pas laisser à la portée des enfants ni manipuler comme un jouet.



Ne pas orienter l'appareil directement vers le rayonnement solaire.

2. Mise en service

Pose / dépose des piles

- 1) Retirer la trappe à piles
- 2) Insérer les piles en respectant la polarité.
- 3) Replacer la trappe à piles.
 - Remplacer les piles lorsque le symbole «  » clignote de façon permanente sur l'afficheur.
 - N'utiliser que des piles alcalines.
 - Retirer les piles en cas de non-utilisation prolongée de l'instrument.



Clavier

- 1) Touche Marche/Mesure
- 2) Touche Surface/Volume
- 3) Touche de Mesure indirecte
- 4) Touche de Mesure Ponctuelle/Continue
- 5) Touche Plus (+)
- 6) Touche Moins (-)
- 7) Touche Lecture mémoires
- 8) Touche Référence
- 9) Touche Rétro-Éclairage et Changement d'unités
- 10) Touche Effacement/Arrêt

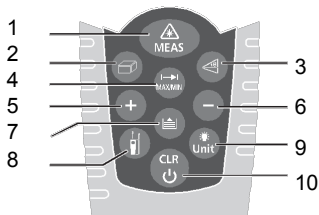

Afficheur LCD

- 1) Laser actif
- 2) Niveau de référence (avant)
- 3) Niveau de référence (arrière)
- 4) Fonction de mesure variable

 Mesure de surface

 Mesure de volume

 Mesure indirecte

 Mesure indirecte (2)

- 5) Mesure simple de distance
- 6) Etat des piles
- 7) Historique mémoire
- 8) Alerte erreur instrument
- 9) Mesure continue & valeurs Max et Min
- 10) Affichage de la première valeur
- 11) Affichage de la seconde valeur
- 12) Affichage de la dernière mesure ou du résultat du calcul.

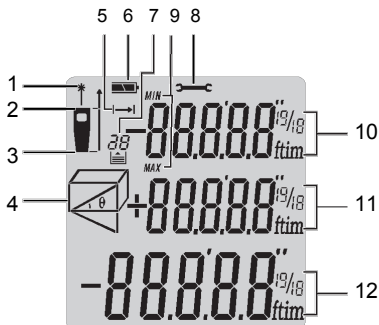

3. Opérations de configuration initiale

Mise en marche et arrêt



Met en fonctionnement l'appareil et allume le laser.



L'appui long sur la touche arrête l'appareil. L'appareil s'arrête automatiquement après 3 minutes d'inactivité.

Touche Effacement



La dernière action est annulée ou l'affichage de la valeur est effacé. En mode mémorisation, l'appui simultané des touches d'effacement et de mémorisation effacera l'ensemble des données en mémoire.

Configuration du niveau de référence

Par défaut, le niveau de référence est situé à l'arrière de l'appareil. Appuyer sur la touche  pour placer la référence à l'avant ↑.

Une indication sonore indique que la référence a été modifiée.

Après une remise en marche, la référence est automatiquement remise à la valeur par défaut (arrière de l'appareil).

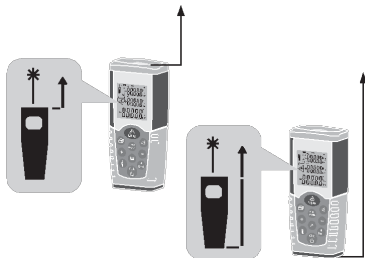

Eclairage de l'afficheur



Appuyer sur la touche Rétro-Éclairage / Unités de façon à allumer ou éteindre le rétro-éclairage de l'afficheur LCD.

Programmation des unités



Un appui long sur cette touche permet de changer les unités de mesures (m, ft, in, ft+in).

4. Mesures

Mesure simple de distance



Appuyer une première fois pour activer le laser.

Appuyer une seconde fois pour déclencher la mesure. La valeur mesurée est alors immédiatement affichée.

Mesures continues (Tracking) & Mesures de Max et Min

Le mode de mesures continues (tracking) est utilisé pour se positionner à une distance donnée, par exemple selon les indications d'un plan. En mode de mesures continues, le télémètre peut être déplacé par rapport à la cible, la mesure est rafraîchie approximativement deux fois par seconde et affichée sur le troisième ligne. Les valeurs minimum et maximum sont automatiquement indiquées sur la première et la seconde ligne.

Par exemple, l'utilisateur peut se déplacer depuis le mur à la distance désirée puisque la distance courante peut être lue de façon continue. Pour le mode continu, appuyer sur



jusqu'à ce que l'indicateur mesure continue apparaisse sur l'afficheur. Appuyer sur la touche MEAS ou sur la touche d'effacement pour arrêter la fonction. La fonction s'interrompt automatiquement après 100 mesures consécutives.

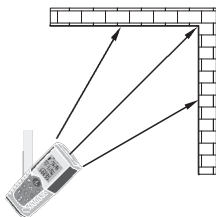
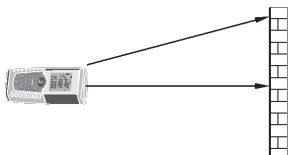

5. Fonctions

Addition / Soustraction

Mesurer une distance :



La mesure suivante est additionnée à la mesure précédente.



La mesure suivante est soustraite à la mesure précédente.





La dernière opération est annulée.



Retour au mode de mesure simple de distance.

Mesure de surface

Appuyer sur la touche Surface / Volume, le symbole  apparaît à l'écran.

Appuyer sur  pour prélever la première mesure (par exemple la longueur).

Appuyer sur  une seconde fois pour prendre la seconde mesure (par exemple la largeur).

Le résultat du calcul de la surface est indiqué à la troisième ligne, les mesures individuelles sont quant à elles rappelées sur les lignes 1 et 2.

Mesures de volume

Pour les mesures de volume, appuyer 2 fois sur la touche Surface / Volume, le symbole  apparaît à l'écran.

 Appuyer pour prendre la première mesure (par exemple la longueur).

 Appuyer pour prendre la seconde distance (par exemple la largeur). Le résultat du calcul de la surface issu de ces mesures est alors affiché sur la ligne 3.



 Appuyer pour prendre la troisième mesure (par exemple la hauteur). Sa valeur est indiquée à la seconde ligne.

Le résultat du calcul de volume est indiqué en troisième ligne.

Mesures indirectes

Les mesures indirectes consistent à déterminer une distance en utilisant deux mesures auxiliaires.

Par exemple la mesure d'une hauteur peut s'effectuer en mesurant les deux autres distances.

Presser le bouton  le symbole  apparaît à l'écran. La distance à mesurer clignote sur le symbole.

 Viser le point haut (mesure 1) et valider la mesure.

Après l'acquisition de la première mesure, mettre l'instrument le plus horizontal possible.

 Appuyer pour prendre la mesure du point horizontal (mesure 2).

Le résultat du calcul est indiqué sur la troisième ligne de l'afficheur.

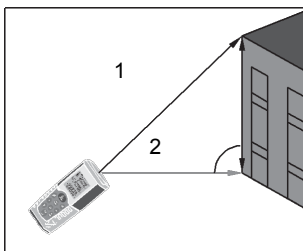

Mesures indirectes – Déterminer une distance avec 3 mesures

Deux appuis sur  ; l'afficheur indique le symbole suivant



La distance à mesurer clignote sur le symbole.



Viser le point bas (1) et valider la mesure. Une fois cette première mesure acquise, placer l'appareil horizontalement.



Appuyer pour prendre la distance au point horizontal (2). Viser ensuite vers le point haut.



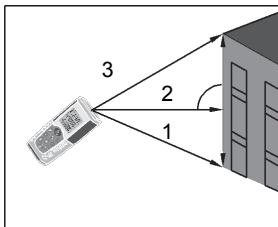

Appuyer pour prendre la distance au point haut (3).

Le résultat du calcul est indiqué sur la troisième ligne de l'afficheur.



Mémorisation



Les 20 derniers enregistrements (mesures ou calculs) sont stockés dans un ordre inverse. Utiliser les touches   pour visualiser ces enregistrements.

Il est possible d'effacer tous les enregistrements en appuyant simultanément sur les touches Enregistrement et Effacement.

6. Spécifications techniques

Spécifications Techniques

Spécifications techniques	Modèle : DM 100
Distance mesurable	0,05 à 50 m* (0.16 ft à 164 ft*)
Incertitude de mesure jusqu'à 10 m (2 σ , déviation standard)	Typique : $\pm 1,5$ mm** (± 0.06 in**)
Unités de mesure	m, in, ft
Classe du laser	Classe 2 - EN 60825-1
Caractéristiques du laser	630 nm – 670 nm, < 1 mW
Calculs de surfaces et de volumes	oui
Mesures indirectes (Pythagore)	oui
Addition / Soustraction	oui
Mesures continues	oui
Recherche de distance Min/Max	oui
Rétro-éclairage et afficheur multi-lignes	oui
Indicateur sonore	oui
Protection	IP 54
Profondeur mémoire	20
Type de clavier	Longue durée
Température de fonctionnement	0°C à 40°C (32°F à 104°F)
Température de stockage	- 10°C à 60°C (14°F à 140°F)
Autonomie des piles	Jusqu'à 4000 mesures
Piles	2 x 1,5V (LR3, AAA)
Arrêt automatique du laser	Après 0,5 min
Arrêt automatique de l'appareil	Après 3 min
Dimensions	115 x 48 x 18 mm
Poids	135 g
Compatibilité électromagnétique	EN 61326-1

* Utiliser une plaque cible pour augmenter l'étendue de mesure si la zone visée présente de faibles propriétés de réflexion.

** En conditions favorables.

En cas de conditions défavorables, cette valeur peut s'accroître de $\pm 0,15$ mm / m (± 0.0018 in / ft) au delà de 10 mètres.

7. Problèmes de fonctionnement

Problèmes de fonctionnement

Code	Cause	Mesure corrective
204	Erreur de calcul	Ré-itérer la procédure
208	Signal reçu trop faible, le temps de mesure est trop long. Distance > 50m	Utilisation d'une plaque cible pour améliorer la réflexion.
209	Signal reçu trop fort	Le point cible est trop réfléchissant, utiliser une cible moins réfléchissante.
252	Température trop élevée	Placer l'appareil dans un endroit tempéré.
253	Température trop froide	Placer l'appareil dans un endroit tempéré.
255	Erreur matériel	Eteindre et allumer l'appareil plusieurs fois. Si le défaut persiste, contacter votre revendeur.

8. Conditions de mesure

Gamme de mesure

La distance mesurable est limitée à 50 mètres.

Au crépuscule ou la nuit, si la cible est dans l'ombre, la distance mesurable sans l'utilisation de plaque cible est augmentée.

Utiliser une plaque cible pour augmenter la distance mesurable durant des mesures de jour ou si la zone de mesure présente des faibles propriétés de réflexion optique.

Surfaces visées

Des erreurs de mesure peuvent se produire en cas de mesure vers des liquides transparents (ex. eau), du verre sans impureté, du polystyrène ou des matériaux semi perméables similaires. Viser vers des surfaces vernies peut dévier le faisceau laser et conduire à des erreurs de mesure. Le temps de mesure peut augmenter si la visée est faite sur des surfaces non-réfléchissantes ou noires.

Précautions

Ne pas immerger l'appareil dans l'eau. Pour retirer la poussière sur la partie optique, utiliser un chiffon doux et moite. Pour le boîtier, ne pas utiliser d'agents de nettoyage agressifs mais de l'eau savonneuse. Les précautions à prendre sont identiques à celles à prendre pour tout appareil optique (téléscope, appareil photo, ...).

9. Etiquette de sécurité

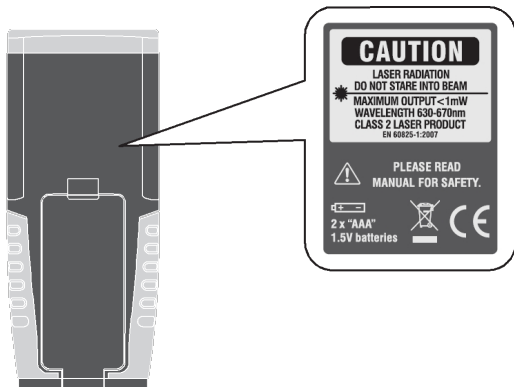

ATTENTION
RAYONNEMENT LASER
NE PAS REGARDER DANS LE FAISCEAU
APPAREIL A LASER DE CLASSE 2

10. Vérification

Rappel de sécurité

Le fabricant ne pourra être tenu responsable de tout accident survenu suite à une réparation ou une modification effectuée en dehors de son service après-vente ou des réparateurs agréés.

Vérification métrologique

Comme tous les appareils de mesure ou d'essais, une vérification périodique est nécessaire. Nous vous conseillons une vérification annuelle de cet appareil. Pour les vérifications et étalonnages, adressez-vous à nos laboratoires de métrologie accrédités COFRAC ou aux centres techniques MANUMESURE.

Renseignements et coordonnées sur demande :
Tél. : 02 31 64 51 55 – Fax : 02 31 64 51 72

11. Garantie

Garantie

Notre garantie s'exerce, sauf stipulation expresse, pendant **douze mois** après la date de mise à disposition du matériel. Extrait de nos Conditions Générales de Vente, communiquées sur demande.

La garantie ne s'applique pas suite à :

- Une utilisation inappropriée de l'équipement ou à une utilisation avec un matériel incompatible,
- Des modifications apportées à l'équipement sans l'autorisation explicite du service technique du fabricant,
- Des travaux effectués sur l'appareil par une personne non agréée par le fabricant,
- Une adaptation à une application particulière, non prévue par la définition du matériel ou non indiquée dans la notice de fonctionnement,
- Des dommages dus à des chocs, chutes ou inondations.

12. Etat de livraison

Télémetre laser DM 100..... P06237503Z

livré sous blister avec 2 piles 1,5 V LR3, une sacoche de transport et la présente notice de fonctionnement.

Contents

1. Safety instructions	18
2. Commissioning.....	19
3. Initial configuration operations	21
4. Measurements	22
5. Functions	23
6. Technical specifications	27
7. Operating problems.....	28
8. Measuring conditions.....	29
9. Safety label	30
10. Check	30
11. Warranty.....	31
12. To order.....	31



WARNING
LASER RADIATION
DO NOT LOOK DIRECTLY INTO THE BEAM
CLASS 2 LASER DEVICE

You have just become the owner of a DM 100 Laser Distance Meter and we thank you for your confidence.

For best results from your device:

- **read** this user manual attentively,
- **observe** the precautions for its use.

The DM 100 Laser Distance Meter is a precision instrument intended for the measurement of distances and lengths; it can also calculate areas and volumes.

1. Safety instructions

Meanings of the symbols used



WARNING, risk of DANGER! The operator agrees to refer to these instructions whenever this danger symbol appears.



Laser radiation, do not look directly into the LASER beam.



The rubbish bin with a line through it means that in the European Union, the product must undergo selective disposal for the recycling of electric and electronic material, in compliance with Directive DEEE-2002/96/EC.



This marking certifies compliance with the European "Low Voltage" and "Electromagnetic Compatibility" directives (73/23/CEE and 89/336/CEE).

Precautions for use

Please refer to this manual each time you encounter a hazard symbol. To avoid laser radiation, injury, or damage to this instrument, and to make sure that you use the distance meter in a risk-free manner, follow the safety advice below:



Do not look directly into the laser beam. Do not point the laser beam at people.



Do not use the instrument other than for its intended purpose; keep it out of reach of children and make sure that it is never treated as a toy.



Do not point the instrument directly at the sun.

2. Commissioning

Installing/ removing the batteries

- 1) Remove the battery compartment cover
- 2) Insert the batteries; make sure that the polarity is correct.
- 3) Put the battery compartment cover back in place.
 - Replace the batteries when the "+" symbol flashes steadily on the display unit.
 - Use only alkaline batteries.
 - Remove the batteries if the instrument is to be left unused for an extended period.



Keypad

- 1) On/Measurement key
- 2) Area/Volume key
- 3) Indirect measurement key
- 4) Max-Min/Continuous measurement key
- 5) Plus key (+)
- 6) Minus key (-)
- 7) Read memories key
- 8) Reference key
- 9) Backlight and Change units key
- 10) Erase/Off key

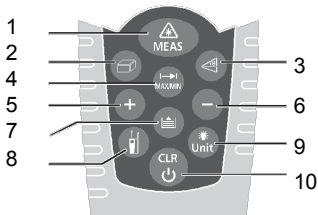

LCD display unit

- 1) Laser active
- 2) Reference level (front)
- 3) Reference level (rear)
- 4) Variable measurement function



Area measurement



Volume measurement



Indirect measurement



Indirect measurement (2)

- 5) Simple distance measurement
- 6) Condition of the batteries
- 7) Memory history
- 8) Instrument error alert
- 9) Continuous measurement & Max and Min values
- 10) Display of the first value
- 11) Display of the second value
- 12) Display of the last measurement or of the calculation result.

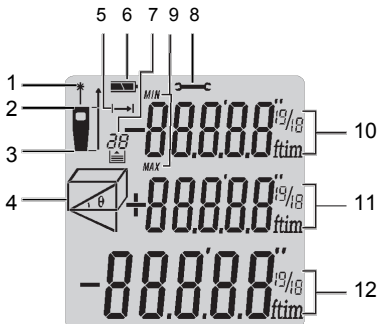

3. Initial configuration operations

Switching on and off



Switches the device on and lights the laser.





A long press on the key switches the device off. The device switches itself off after 3 minutes of non-use.

Erase key



The last action is cancelled or the value displayed is erased. In the store mode, pressing the erase and store keys simultaneously erases all stored data.

Choosing the reference level

The default reference level is on the rear of the device. Press the  key to shift the reference to the front .

An audible signal indicates that the reference has been changed.

When the device is switched back on, the reference automatically returns to the default position (rear of the device).

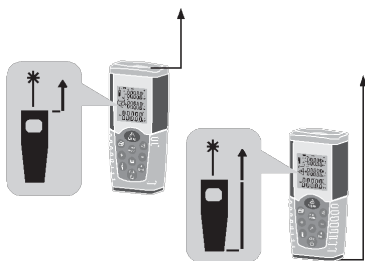

Lighting of the display unit



Press the Backlight/Units key to switch the backlighting of the LCD display unit on or off.

Programming the units



A long press on this key changes the measurement unit (m, ft., in, ft+in).

4. Measurements

Simple distance measurement



Press once to activate the laser.

Press again to trigger the measurement. The value measured is displayed immediately.

Continuous measurement (Tracking) & Measurements of Max and Min

The continuous (tracking) measurement mode is used to locate a specified distance, for example one marked on a drawing. In the continuous measurement mode, the distance meter can be moved with respect to the target; the reading is refreshed approximately twice a second and displayed on the third line. The minimum and maximum values are automatically indicated on the first and second lines.

For example, the user can move away from a wall to the desired distance, since the current distance can be read continuously. For the continuous mode, press  until

the continuous measurement indicator appears on the display unit. Press the MEAS key or the erase key to stop the function. The function stops automatically after 100 successive measurements.

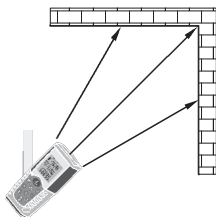
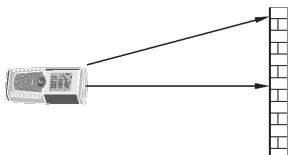

5. Functions

Addition/ Subtraction

Measure a distance:



The next measurement is added to the previous measurement.



The next measurement is subtracted from the previous measurement.





The last operation is cancelled.



Return to the simple distance measurement mode.

Measurement of area

Press the Area/Volume key; the  symbol appears on the screen.

Press  to display the first measurement (for example the length).

Press  again to display the second measurement (for example the width).

The result of the area calculation is indicated on the third line, the individual measurements appear on lines 1 and 2.

Measurements of volume

For volume measurements, press the Area/Volume key twice; the  symbol appears on the screen.



Press to take the first measurement (for example the length).



Press to take the second distance (for example the width). The result of the area calculation based on these measurements is then displayed on line 3.





Press to take the third measurement (for example the height). Its value is indicated on the second line.

The result of the volume calculation is indicated on the third line.

Indirect measurements

An indirect measurement determines a distance using two auxiliary measurements.

A height, for example, can be measured by measuring two other distances.

Press the  button; the  symbol appears on the screen. The distance to be measured flashes on the symbol.



Aim at the high point (measurement 1) and validate the measurement.

After the acquisition of the first measurement, place the instrument as nearly horizontal as possible.



Press to take the measurement of the horizontal point (measurement 2).

The result of the calculation is indicated on the third line of the display unit.

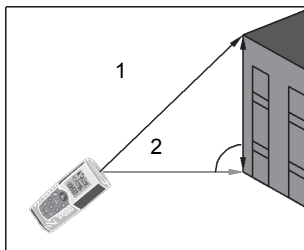

Indirect measurements – Determine a distance using 3 measurements

Press



twice; the display unit shows the following symbol:



The distance to be measured flashes on the symbol.



Aim at the low point (1) and validate the measurement. Once this first measurement has been acquired, place the device horizontally.



Press to take the distance to the horizontal point (2). Then aim at the high point.



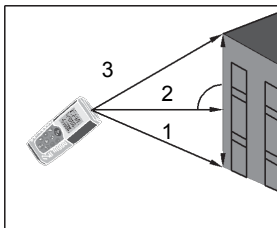

Press to take the distance to the high point (3).

The result of the calculation is indicated on the third line of the display unit.



Storage



The last 20 records (measurements or calculations) are stored, in reverse order. Use the   keys to display these records.

It is possible to erase all of the records by pressing the Record and Erase keys simultaneously.

6. Technical specifications

Technical specifications

Technical specifications	Model: DM 100
Distance measurable	0.05 to 50 m* (0.16 ft to 164 ft*)
Measurement uncertainty up to 10m (2 σ , standard deviation)	Typical: ± 1.5 mm** (± 0.06 in**)
Measurement units	m, in, ft
Class of the laser	Class 2 – EN 60825-1
Characteristics of the laser	630 nm – 670 nm, < 1 mW
Calculations of areas and of volumes	yes
Indirect measurements (Pythagoras function)	yes
Addition/Subtraction	yes
Continuous measurements	yes
Search for Min/Max distance	yes
Backlighting and multiline display unit	yes
Audible indicator	yes
Protection	IP54
Memory depth	20
Type of keypad	Long-life
Operating temperature	0°C to 40°C (32°F to 104°F)
Storage temperature	-10°C to 60°C (14°F to 140°F)
Battery life	Up to 4,000 measurements
Batteries	2 x 1.5 V (LR3, AAA)
Automatic switching off of the laser	After 0.5 min
Automatic switching off of the device	After 3 min
Dimensions	115 x 48 x 18 mm
Weight	135 g
Electromagnetic compatibility	EN 61326-1

* Use a target plate to increase the measurement range if the zone aimed at is a poor reflector.

** Assuming favourable conditions.

If conditions are unfavourable, this value may increase by ± 0.15 mm/m (± 0.0018 in/ft) beyond 10 metres.

7. Operating problems

Operating problems

Code	Cause	Corrective action
204	Calculation error	Redo the procedure
208	Signal received too weak, the measurement time is too long. Distance > 50 m	Use a target plate to improve the reflection.
209	Signal received too strong	The target point is too reflecting; use a less reflecting target.
252	Temperature too high	Place the instrument in a cooler location.
253	Temperature too low	Place the instrument in a warmer location.
255	Hardware error	Switch the device off and back on several times. If the fault persists, contact your dealer.

8. Measuring conditions

Measurement range

The distance that can be measured is limited to 50 metres.

At dusk or at night, if the target is in shade, the distance that can be measured without using a target plate is increased.

Use a target plate to increase the distance that can be measured in daylight or if the measurement zone has poor optical reflection properties.

Surfaces aimed at

Measurement errors may occur in the case of measurements made in the direction of transparent liquids (such as water), glass that is free of impurities, polystyrene, or similar semipermeable materials. Aiming at varnished surfaces may deflect the laser beam and lead to measurement errors. The time required for a measurement may increase if the device is aimed at non-reflecting or black surfaces.

Precautions

Do not immerse the device in water. To remove dust from the optical part, use a damp soft cloth. For the housing, use soapy water, not aggressive cleaning agents. The precautions to be taken are the same as for any optical instrument (telescope, camera, etc.).

9. Safety label

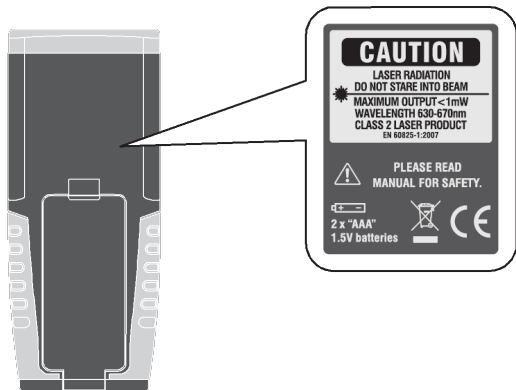

WARNING
LASER RADIATION
DO NOT LOOK DIRECTLY INTO THE BEAM
CLASS 2 LASER DEVICE

10. Check

Safety reminder

The manufacturer cannot be held liable for any accident that occurs following a repair not performed by its customer service department or by an approved repairer.

Metrological check

Like all measuring or testing devices, the instrument must be checked regularly. We recommend checking this instrument yearly. For checks and calibrations, contact one of our accredited metrology laboratories (information and contact details available on request), at our Chauvin Arnoux subsidiary or the branch in your country.

11. Warranty

Warranty

Except as otherwise stated, our warranty is valid for **twelve months** starting from the date on which the equipment was sold. Extract from our General Conditions of Sale provided on request.

The warranty does not apply in the following cases:

- Inappropriate use of the equipment or use with incompatible equipment,
- Modifications made to the equipment without the explicit permission of the manufacturer's technical staff,
- Work done on the device by a person not approved by the manufacturer,
- Adaptation to a particular application not anticipated in the definition of the equipment or not indicated in the user's manual,
- Damage caused by shocks, falls, or floods.

12. To order

Laser Distance Meter DM 100 P06237503Z

delivered in blister pack with 2 1.5 V LR3 batteries, a carrying case, and this user manual.

INHALT

1. Sicherheitshinweise	33
2. Inbetriebnahme	34
3. Erklärung der Original-Gerätekonfiguration	36
4. Messung	37
5. Funktionen	38
6. Technische Daten	42
7. Betriebsstörungen	43
8. Messbedingungen	44
9. Aufkleber mit Sicherheitshinweis	45
10. Prüfung	45
11. Garantie	46
12. Lieferumfang	46



ACHTUNG!

LASERSTRAHL

NICHT DIREKT IN DEN STRAHL BLICKEN!

GERÄT MIT LASER KLASSE 2

Sie haben einen **Laser-Entfernungsmesser DM 100** erstanden, wir danken Ihnen für Ihr Vertrauen.

Für die Erlangung eines optimalen Betriebsverhaltens Ihres Gerätes:

- **Lesen Sie** bitte diese Betriebsanleitung aufmerksam durch und
- **Beachten Sie** bitte die Anwendungshinweise.

Der **Laser-Entfernungsmesser DM 100** ist ein Präzisionsgerät zur Entfernung- bzw. Längenmessung, das außerdem die Berechnung von Flächenwerten und Volumina ermöglicht.

1. Sicherheitshinweise

Bedeutung der verwendeten Symbole



ACHTUNG – GEFAHR! Sobald dieses Gefahrenzeichen auftritt, ist der Bediener verpflichtet, die Anleitung zu Rate zu ziehen.



Achtung LASER - blicken Sie nicht selbst in den Laserstrahl!



Das Symbol „durchgestrichener Mülleimer“ weist darauf hin, dass dieses Gerät in der EU gemäß der EC-Richtlinie für Elektro- und Elektronikschrott WEEE 2002/96/EC entsorgt und recycelt werden muss.



Das Gerät erfüllt die EMV- und Niederspannungsrichtlinien (73/23/EWG und 89/336/EWG).

Gebrauchsgefahren

Lesen Sie bitte jedes Mal in dieser Anleitung nach, wenn Sie auf ein Gefahrensymbol stoßen. Für die gefahrlose Anwendung dieses Entfernungsmessers, und um Laserstrahlen, Körperverletzungen bzw. Beschädigung des Geräts zu verhindern, befolgen Sie bitte diese Sicherheitshinweise:



Blicken Sie nicht selbst in den Laserstrahl. Richten Sie den Laserstrahl nicht auf Personen.



Das Gerät nur für den vorgesehenen Zweck anwenden. Für Kinder unerreichbar aufbewahren. Lassen Sie Kinder das Messwerkzeug nicht als Spielzeug benutzen.



Richten Sie das Messwerkzeug nicht nach direkter Sonneneinstrahlung.

2. Inbetriebnahme

Batterien einsetzen / ersetzen

- 1) Batteriefach abnehmen.
- 2) Batterien polrichtig einsetzen.
- 3) Batteriefach wieder schließen.
 - Batterie wechseln, wenn dieses Symbol "  dauerhaft im Display blinkt.
 - Nur alkaline Batterien verwenden.
 - Vor längerem Nichtgebrauch die Batterie entfernen.



Tastatur

- 1) Ein/Messen-Taste
- 2) Fläche/Volumen-Taste
- 3) Indirekte Messung-Taste
- 4) Punkt- /Dauermessung-Taste
- 5) Plus (+)-Taste
- 6) Minus (-)-Taste
- 7) Taste für Speicherabruf
- 8) Messebene-Taste
- 9) Taste Displaybeleuchtung und Maßeinheiten
- 10) Clear/Aus-Taste

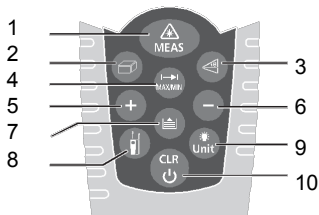

LCD-Anzeige

- 1) Laser eingeschaltet
- 2) Messebene (vorne)
- 3) Messebene (hinten)
- 4) Variable Messfunktion



Flächen-Messung



Volumenmessung



Indirekte Messung



Indirekte Messung (2)

- 5) Einzeldistanzmessung
- 6) Akku-Ladezustand
- 7) Historienspeicher
- 8) Fehleranzeige
- 9) Dauermessung und Maximum/Minimum-Messung
- 10) Anzeige erster Wert
- 11) Anzeige zweiter Wert
- 12) Anzeige letztes Mess- oder Rechnungsergebnisses

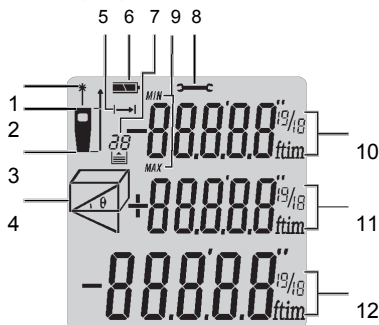

3. Erklärung der Original-Gerätekonfiguration

Ein- /Ausschalten



Schaltet das Gerät und den Laser ein.



Mit langem Tastendruck wird das Gerät ausgeschaltet.

Das Gerät schaltet sich außerdem nach 3 Minuten ohne Tastenbetätigung automatisch aus.

Clear-Taste



Der letzte Vorgang wird rückgängig gemacht bzw. die Wertanzeige wird gelöscht. Im MEM-Modus: Bei gleichzeitiger Betätigung der Tasten „Clear“ und „Speichern“ werden alle Speicherdaten gelöscht.

Messebene einstellen

Mit der Taste



verlegt

wird die Messebene nach vorne

Ein akustisches Signal ertönt, wenn die Messebene geändert wurde.

Nach einem Einschalten springt die Messebene automatisch auf die Standareinstellung (hintere Messebene) zurück.

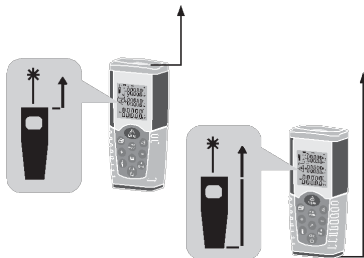

Display- beleuchtung



Mit der Taste Displaybeleuchtung/Maßeinheit schaltet man die Beleuchtung des LCD-Displays ein und aus.

Programmierung der Maßeinheiten



Mit langem Tastendruck werden die Maßeinheiten (m, ft, in, ft+in) gewechselt.

4. Messung

Einzeldistanz messung



Taste ein Mal drücken: Laser wird aktiviert.

Ein zweiter Druck löst die Distanzmessung aus. Der Messwert wird sofort angezeigt.

Dauermessung (Tracking) & Maximum/Mini- mum-Messung

Mit der Dauermessung (Tracking) lässt sich die eigene Position zum Beispiel nach Planangaben auf einen vorgegebenen Abstand bestimmen. Bei diesem Messmodus wird die Position des Entfernungsmessers, der auf das Ziel gerichtet ist, geändert. Etwa zwei Mal pro Sekunde wird gemessen und der Messwert in der dritten Zeile angezeigt. Die Minimum- und Maximumwerte erscheinen automatisch auf der ersten und zweiten Zeile.

Anwendungsbeispiel: Der Anwender entfernt sich von einer Wand, bis der gewünschte Abstand erreicht ist, dabei liest er die jeweilige Distanz laufend vom Gerät ab.



Dauermodus öffnen: Drücken, bis das Tracking-Symbol auf der Anzeige erscheint. Zum Beenden der Funktion die Taste MEAS oder die Clear-Taste drücken. Nach 100 Messungen wird die Funktion automatisch abgebrochen.

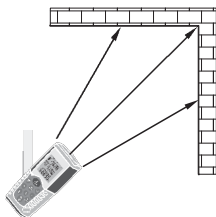
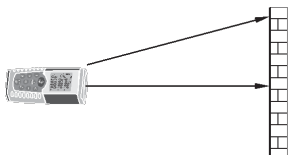

5. Funktionen

Addition / Subtraktion

Distanz messen:



Die nächste Messung wird zur vorhergehenden addiert.



Die nächste Messung wird von der vorhergehenden subtrahiert.





Die letzte Operation wird rückgängig gemacht.



Zurück zur einfachen Distanzmessung.

Flächen- Messung

Taste Fläche/Volumen drücken. Das Symbol
erscheint am Display. 

Taste  drücken und erstes Längenmaß messen
(z.B. Länge).

Taste  drücken und zweites Längenmaß messen
(z.B. Breite).

Das berechnete Flächenmaß erscheint in der dritten Zeile,
die einzelnen Messwerte werden in der 1. und 2. Zeile
angezeigt.

Volumen- Messung

Taste Fläche/Volumen zwei Mal drücken. Das Symbol
 erscheint am Display.

 Taste drücken und erstes Maß messen (z.B.
Länge).

 Taste drücken und zweites Maß messen (z.B.
Breite). Der aus diesen Maßen errechnete
Flächenwert wird auf Zeile 3 angezeigt.

 Taste drücken und drittes Maß messen (z.B.
Höhe). Der Wert wird in der zweiten Zeile
angezeigt.

Der berechnete Volumen-Wert steht in der dritten Zeile.

Indirekte Messungen

Die indirekten Messungen bestimmen eine Strecke mit zwei Hilfsmessungen.

So kann zum Beispiel der Höhenwert durch Messen der beiden anderen Distanzen ermittelt werden.

Taste  drücken. Am Display erscheint das

Symbol . Die jeweils gemessene Strecke blinkt auf dem Symbol.



Oberen Punkt (Messung 1) anzielen und Messung auslösen.

Nach Erfassung des ersten Messwerts wird das Gerät nun so waagrecht wie möglich ausgerichtet.



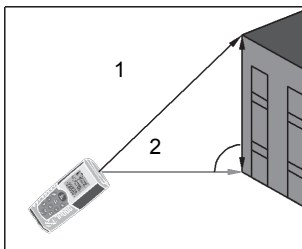

Nun den horizontalen Punkt anzielen (Messung 2) und Messung auslösen.

Das Ergebnis wird in der dritten Zeile angezeigt.





Indirekte Messung - Bestimmen einer Strecke mit 3 Hilfsmessungen

Taste  zwei Mal drücken, im Display erscheint folgendes Symbol

 Die jeweils gemessene Strecke blinkt auf dem Symbol.

 Unteren Punkt (1) anzielen und Messung auslösen. Nach der ersten Messung wird der Wert übernommen. Das Gerät nun möglichst waagrecht halten.

 Nun den horizontalen Punkt anzielen (Messung 2) und Messung auslösen. Anschließend den oberen Punkt anzielen.

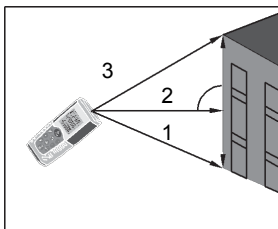

 Taste drücken und oberen Punkt anzielen (3).

Das Ergebnis wird in der dritten Zeile angezeigt.



MEM-Funktion (Speicher)

 Die letzten 20 Speicherdaten (Mess- oder Rechenwerte) werden in umgekehrter Reihenfolge abgelegt.

Verwenden Sie die Tasten   für die Anzeige der Speicherwerte.

Durch gleichzeitiges Drücken der Speicher- und Clear-Tasten werden alle Werte im Historienspeicher gelöscht.

6. Technische Daten

Technische Daten

Technische Daten	Modell: DM 100
Messbereich	0,05 bis 50m* (0.16 ft bis 164 ft*)
Messgenauigkeit bis 10 m (2 σ , Standardabweichung)	Typisch: $\pm 1,5$ mm** (± 0.06 in**)
Messeinheiten	m, in, ft
Laserklasse	Klasse 2 – EN 60825-1
Laserkennwerte	630 nm – 670 nm, < 1 mW
Flächen- und Volumenmessung	ja
Indirekte Messung mittels Pythagoras	ja
Addition / Subtraktion	ja
Dauermessung	ja
Minimum / Maximummessung	ja
Displaybeleuchtung, mehrzellige Anzeige	ja
Tonsignal	ja
Schutzart	IP54
Historischer Speicher	20
Tastaturart	Langzeit
Betriebstemperatur	0°C bis 40°C (32°F bis 104°F)
Lagerungstemperatur	-10°C bis 60°C (14°F bis 140°F)
Batterielebensdauer	bis zu 4000 Messungen
Batterien	2 x 1,5 V (LR3, AAA)
Abschaltautomatik: Laser	Nach 0,5 Min.
Abschaltautomatik: Gerät	Nach 3 Min.
Größe	115 x 48 x 18 mm
Gewicht	135 g
Elektromagnetische Verträglichkeit	EN 61326-1

* Bei Zielen mit schlechten Reflexionseigenschaften eine Zieltafel verwenden, um den Messbereich zu vergrößern.

** Bei günstigen Bedingungen.

Bei ungünstigen Bedingungen kann die Abweichung bei Entfernungen über 10m um $\pm 0,15$ mm/m (± 0.0018 in/ft) steigen.

7. Betriebsstörungen

Betriebsstörungen	Code	Ursache	Abhilfe
	204	Fehler in der Berechnung	Vorgang wiederholen
	208	Empfangssignal zu schwach, Messzeit zu lang Abstand > 50 m	Zieltafel benutzen, um Reflexionseigenschaften zu verbessern
	209	Eingangssignal zu hoch	Ziel zu stark reflektierend, einen weniger stark reflektierenden Zielpunkt anpeilen
	252	Temperatur zu hoch	Gerät an einen kühleren Standort bringen
	253	Temperatur zu niedrig	Gerät an einen wärmeren Standort bringen
	255	Hardwarefehler	Gerät mehrmals aus- und einschalten. Wenn der Fehler damit nicht behoben ist, wenden Sie sich bitte an Ihren Vertrieb.

8. Messbedingungen

Reichweite

Die Reichweite ist auf 50 m begrenzt.

Bei Nacht, in der Dämmerung oder bei abgeschatteten Zielen erhöht sich die Reichweite ohne Verwendung der Zieltafel.

Bei Tageslicht und bei Zielen mit schlechten Reflexionseigenschaften Zieltafel verwenden, um die Reichweite zu vergrößern.

Oberflächen von Zielen

Messfehler können bei Messungen gegen farblose Flüssigkeiten (z.B. Wasser), fehlerfreies, sauberes Glas, Styropor oder ähnlich halblichtdurchlässige Oberflächen auftreten. Messfehler können bei stark reflektierenden Zielen auftreten, weil sie den Laserstrahl ablenken. Beim Anpeilen nicht reflektierender bzw. schwarzer Flächen kann sich die Messzeit verlängern.

Anwendungs- hinweise

Niemals in Wasser tauchen. Wischen Sie Schmutz mit einem feuchten, weichen Tuch vom Optik-Teil des Geräts ab. Verwenden Sie für das Gehäuse keine aggressiven Reinigungsmittel, sondern Seifenwasser. Behandeln Sie das Gerät mit gleicher Vorsicht wie andere Optik-Geräte auch (Fernglas oder Kamera).

9. Aufkleber mit Sicherheitshinweis

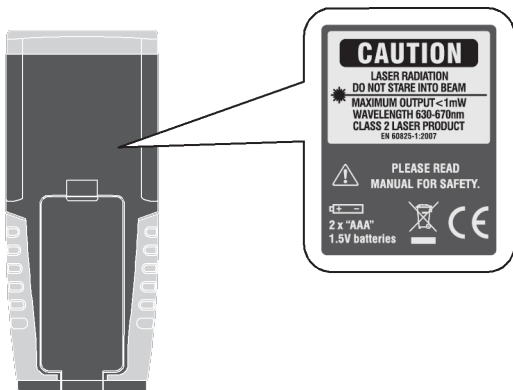

ACHTUNG!
LASERSTRAHL
NICHT DIREKT IN DEN STRAHL BLICKEN!
GERÄT MIT LASER KLASSE 2

10. Prüfung

Sicherheits- hinweis

Der Hersteller haftet keinesfalls für Unfälle, die durch Reparaturen bzw. Änderungen außerhalb seines Kundendienstnetzes oder durch nicht von ihm zugelassene Reparaturdienste verursacht wurden.

Eichung

Wie auch bei anderen Mess- oder Prüfgeräten ist eine regelmäßige Geräteüberprüfung erforderlich.

Es wird mindestens eine einmal jährlich durchgeführte Überprüfung dieses Gerätes empfohlen. Für Überprüfung und Kalibrierung wenden Sie sich bitte an unsere zugelassenen Messlabors (Auskunft und Adressen auf Anfrage), bzw. an die Chauvin Arnoux Niederlassung oder den Händler in Ihrem Land.

11. Garantie

Garantie

Mit Ausnahme von ausdrücklichen anders lautenden Vereinbarungen ist die Garantiezeit zwölf Monate ab Bereitstellung des Geräts beim Kunden. Auszug aus den Allgemeinen Geschäftsbedingungen (Gesamtext auf Anfrage).

Die Garantie verfällt bei:

- Unsachgemäße Benutzung des Gerätes oder Verwendung mit inkompatiblen anderen Geräten;
- Veränderung des Geräts ohne die ausdrückliche Genehmigung der technischen Abteilung des Herstellers;
- Eingriffe in das Gerät durch eine nicht vom Hersteller dazu befugte Person;
- Anpassung des Geräts an nicht vorgesehene und nicht in der Anleitung aufgeführte Verwendungszwecke;
- Schäden durch Stöße, Herunterfallen, Überschwemmung.

12. Lieferumfang

Laser-Entfernungsmesser DM 100 P06237503Z

Lieferung in Blisterverpackung mit 2 x 1,5 V LR3 Batterien, einer Transporttasche und dieser Bedienungsanleitung.

Indice

1. Istruzioni di sicurezza	48
2. Messa in servizio	49
3. Operazioni di configurazioni iniziale	51
4. Misure.....	52
5. Funzioni	53
6. Specifiche tecniche	57
7. Problemi di funzionamento.....	58
8. Condizioni di misura	59
9. Etichetta di sicurezza	60
10. Verifica	60
11. Garanzia.....	61
12. Per ordinare	61



ATTENZIONE
RADIAZIONE LASER
NON GUARDARE IL FASCIO
APPARECCHIO A LASER DI CLASSE 2

Avete appena acquistato un **Telemetro Laser DM 100** e vi ringraziamo della vostra fiducia.

Per ottenere le migliori prestazioni dal vostro strumento:

- **seguite** attentamente le presenti istruzioni per l'uso,
- **rispettate** le precauzioni d'uso.

Il **Telemetro Laser DM 100** è uno strumento di precisione destinato alla misura delle distanze o lunghezze con possibilità di calcolo delle superfici o dei volumi.

1. Istruzioni di sicurezza

Significato dei simboli utilizzati



ATTENZIONE, rischio di PERICOLO! L'operatore s'impegna a consultare il presente manuale ogni volta che vedrà questo simbolo di pericolo.



Radiazioni laser: non guardare direttamente il fascio LASER.



La pattumiera sbarrata significa che nell'Unione Europea, il prodotto costituisce un rifiuto da smistare per l'opportuno riciclo dei materiali elettrici ed elettronici conformemente alla direttiva DEEE-2002/96/EC.



Questa marcatura garantisce la conformità alle direttive europee "Bassa Tensione" e "Compatibilità Elettromagnetica" (73/23/CEE e 89/336/CEE).

Precauzioni d'uso

Il presente libretto va consultato quando si incontra un simbolo di rischio di pericolo. Per evitare le radiazioni laser, eventuali lesioni o danni al presente apparecchio, e accertarsi del corretto uso del telemetro, seguite i consigli di sicurezza forniti in questa sede:



Non guardare direttamente il fascio laser. Non dirigere il fascio laser verso le persone.



Non usare l'apparecchio al di fuori del suo ambito d'utilizzo, non lasciare alla portata dei bambini e non manipolare come un giocattolo.



Non orientare l'apparecchio direttamente verso il sole.

2. Messa in servizio

Posa e rimozione delle pile

- 1) Rimuovere lo sportello delle pile
- 2) Inserire le pile rispettando la polarità.
- 3) Mettere al suo posto lo sportello delle pile.
 - Sostituire le pile quando il simbolo "  " lampeggia in maniera permanente sul display.
 - Utilizzare solo pile alcaline.
 - Rimuovere le pile in caso di prolungato inutilizzo dello strumento.



Tastiera

- 1) Tasto Marcia/Misura
- 2) Tasto Superficie/Volume
- 3) Tasto di Misura indiretta
- 4) Tasto di Misura Occasionale/Continua
- 5) Tasto Più (+)
- 6) Tasto Meno (-)
- 7) Tasto Lettura memorie
- 8) Tasto Riferimento
- 9) Tasto Retroilluminazione e Cambio d'unità
- 10) Tasto Cancellare/Arresto

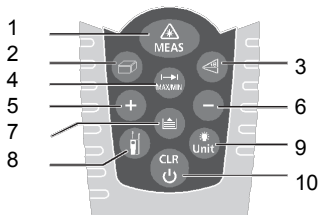

Display LCD

- 1) Laser attivo
- 2) Livello di riferimento (anteriore)
- 3) Livello di riferimento (posteriore)
- 4) Funzione di misura variabile



Misura di superficie



Misura di volume



Misura indiretta



Misura indiretta (2)

- 5) Misura semplice di distanza
- 6) Stato delle pile
- 7) Cronologia memoria
- 8) Allerta errore strumento
- 9) Misura continua & valori Maxi e Mini
- 10) Visualizzazione del primo valore
- 11) Visualizzazione del secondo valore
- 12) Visualizzazione dell'ultima misura o del risultato del calcolo.

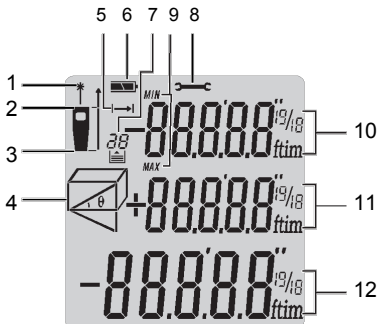

3. Operazioni di configurazione iniziale

Messa in marcia e arresto



Mette in funzione l'apparecchio e accende il laser.



La pressione lunga sul tasto spegne l'apparecchio. L'apparecchio si spegne automaticamente dopo 3 minuti d'inattività.

Tasto Cancellazione



L'ultima azione è annullata oppure la visualizzazione del valore viene cancellata. In modo memorizzazione, la pressione simultanea dei tasti di soppressione e di memorizzazione cancellerà l'insieme dei dati in memoria.

Configurazione del livello di riferimento

Per difetto, il livello di riferimento si trova dietro l'apparecchio. Premere il tasto  per posizionare il riferimento sul davanti.



Un segnale sonoro indica che il riferimento è stato modificato.

Dopo una rimessa in marcia, il riferimento ritorna automaticamente al valore per difetto (retro dell'apparecchio).

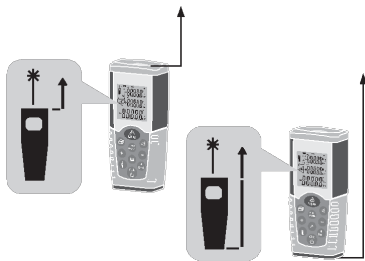

Illuminazione del display



Premere il tasto Retroilluminazione/Unità in maniera da accendere o spegnere la retroilluminazione del display LCD.

Programmazione delle unità



Una pressione lunga su questo tasto permette di cambiare le unità di misure (m, ft., in, ft+in).

4. Misure

Misura semplice di distanza



Premere una prima volta per attivare il laser.

Premere una seconda volta per attivare la misura. Il valore misurato è allora immediatamente visualizzato.

Misure continue (Tracking) & Misure di Maxi e Mini

Il modo “misure continue” (tracking) si utilizza per posizionarsi ad una data distanza, per esempio secondo le indicazioni di un piano. In modo “misure continue”, è possibile spostare il telemetro rispetto al bersaglio, la misura è rinfrescata approssimativamente due volte al secondo e visualizzata sulla terza linea. I valori “minimo” e “massimo” sono automaticamente indicati sulla prima e sulla seconda linea.

Per esempio, l'utente può spostarsi dal muro alla distanza desiderata poiché è possibile leggere la distanza corrente in maniera continua. Per il modo continuo, premere



fino quando l'indicatore misura continua apparirà sul display. Premere il tasto MEAS oppure il tasto di cancellazione per fermare la funzione. La funzione s'interrompe automaticamente dopo 100 misure consecutive.

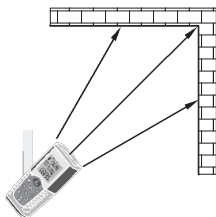
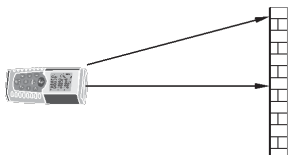

5. Funzioni

Addizione e Sottrazione

Misurare una distanza:



La misura seguente viene addizionata alla misura precedente.



La misura seguente viene sottratta dalla misura precedente.



L'ultima operazione è annullata.



Ritorno al modo di misura semplice di distanza.

Misura di superficie

Premere il tasto Superficie/Volume: appare sullo schermo il simbolo .

Premere  per visualizzare la prima misura (per esempio la lunghezza).

Premere una  seconda volta per prendere la seconda misura (per esempio la larghezza).

Il risultato del calcolo della superficie è indicato alla terza linea, le misure individuali sono invece riportate sulle linee 1 e 2.

Misure di volume

Per le misure di volume, premere 2 volte il tasto Superficie/Volume: sullo schermo appare il simbolo .



Premere per prendere la prima misura (per esempio la lunghezza).



Premere per prendere la seconda distanza (per esempio la larghezza). Il risultato del calcolo della superficie fornito da queste misure si visualizza allora sulla linea 3.





Premere per prendere la terza misura (per esempio l'altezza). Il suo valore è indicato sulla seconda linea.

Il risultato del calcolo del volume è indicato sulla terza linea.

Misure indirette

Le misure indirette consistono nel determinare una distanza utilizzando due misure ausiliari.

Per esempio è possibile effettuare la misura di un'altezza misurando le altre due distanze.

Premere il bottone:  il simbolo  appare sullo schermo. La distanza da misurare lampeggia sul simbolo.



Mirare il punto alto (misura 1) e convalidare la misura.

Dopo l'acquisizione della prima misura, posizionare lo strumento per quanto possibile orizzontale.



Premere per prendere la misura del punto orizzontale (misura 2).

Il risultato del calcolo è indicato sulla terza linea del display.

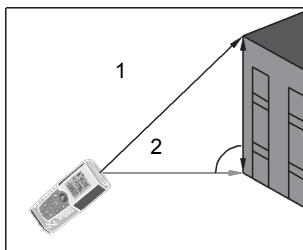

Misure indirette – Determinare una distanza con 3 misure

Due pressioni su:
simbolo



il display indica il seguente

La distanza da misurare lampeggia sul simbolo.



Mirare il punto basso (1) e convalidare la misura. Una volta acquisita questa prima misura, mettere l'apparecchio orizzontalmente.



Premere per prendere la distanza nel punto orizzontale (2). Mirare in seguito verso il punto alto.



Premere per prendere la distanza nel punto alto (3).

Il risultato del calcolo è indicato sulla terza linea del display.

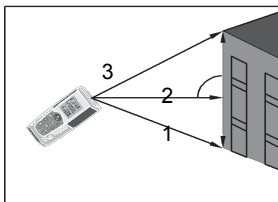

Memorizzazione



Le ultime 20 registrazioni (misure o calcoli) sono stoccate in un ordine inverso. Utilizzare i tasti **+** **-** per visualizzare queste registrazioni.

E' possibile cancellare tutte le registrazioni premendo simultaneamente i tasti Registrazione e Cancellazione.

6. Specifiche tecniche

Specifiche Tecniche

Specifiche tecniche	Modello: DM 100
Distanza misurabile	Da 0,05 a 50 m* (0.16 ft a 164 ft*)
Incertezza di misura fino a 10m (2 σ , deviazione standard)	Tipico: $\pm 1,5$ mm** (± 0.06 in**)
Unità di misura	m, in, ft
Classe del laser	Classe 2 – EN 60825-1
Caratteristiche del laser	630 nm – 670 nm, < 1 mW
Calcoli di superfici e di volumi	Si
Misure indirette (Pitagora)	Si
Addizione/Sottrazione	Si
Misure continue	Si
Ricerca di distanza Mini/Maxi	Si
Retroilluminazione e display multilinee	Si
Indicatore sonoro	Si
Protezione	IP54
Profondità memoria	20
Tipo di tastiera	Lunga durata
Temperatura di funzionamento	Da 0°C a 40°C (da 32°F a 104°F)
Temperatura di stoccaggio	Da -10°C a 60°C (da 14°F a 140°F)
Autonomia delle pile	Fino a 4000 misure
Pile	2 x 1,5 V (LR3, AAA)
Arresto automatico del laser	Dopo 0,5 minuti
Arresto automatico dell'apparecchio	Dopo 3 minuti
Dimensione	115 x 48 x 18 mm
Peso	135 g
Compatibilità elettromagnetica	EN 61326-1

* Utilizzare una piastra bersaglio per aumentare l'ampiezza di misura se la zona mirata presenta deboli proprietà di riflessione.

** In condizioni favorevoli.

In caso di condizioni sfavorevoli, questo valore può aumentare di $\pm 0,15$ mm/m (± 0.0018 in/ft) oltre 10 metri.

7. Problemi di funzionamento

Problemi di funzionamento

Codice	Causa	Misura correttiva
204	Errore di calcolo	Reiterare la procedura
208	Segnale ricevuto troppo debole, il tempo di misura è troppo lungo. Distanza > 50 m	Utilizzo di una piastra bersaglio per migliorare la riflessione.
209	Segnale ricevuto troppo forte	Il punto bersaglio è troppo riflettente, utilizzare un bersaglio meno riflettente.
252	Temperatura troppo elevata	Installare l'apparecchio in un locale temperato.
253	Temperatura troppo fredda	Installare l'apparecchio in un locale temperato.
255	Errore materiale	Spegnere e accendere l'apparecchio varie volte. Se il difetto persiste, contattare il vostro rivenditore.

8. Condizioni di misura

Gamme di misura

La distanza misurabile è limitata a 50 metri.

Al crepuscolo o di notte, se il bersaglio è nell'ombra, la distanza misurabile senza l'utilizzo di piastra bersaglio viene aumentata.

Utilizzare una piastra bersaglio per aumentare la distanza misurabile durante le misure diurne o se la zona di misura presenta deboli proprietà di riflessione ottica.

Superfici mirate

Possono prodursi errori di misura in caso di misura verso liquidi trasparenti (per esempio l'acqua), il vetro esente da impurità, il polistirene o i materiali semipermeabili affini. Mirare verso le superfici verniciate può deviare il fascio laser e condurre a errori di misura. Il tempo di misura può aumentare se la mira concerne superfici non riflettenti o nere.

Precauzioni

Non immergere l'apparecchio nell'acqua. Per eliminare la polvere sulla parte ottica, utilizzare un panno soffice e leggermente umido. Per la cassa, non utilizzare detergenti aggressivi ma acqua saponata. Le precauzioni da prendere sono identiche a quelle da prendere per qualsiasi apparecchio ottico (telescopio, apparecchio foto, ...).

9. Etichette di sicurezza

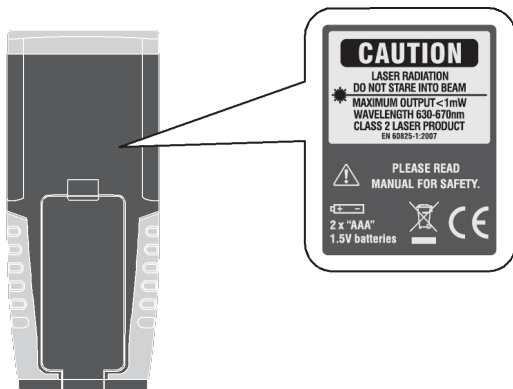

ATTENZIONE
RADIAZIONE LASER
NON GUARDARE IL FASCIO
APPARECCHIO A LASER DI CLASSE 2

10. Verifica

Promemoria di sicurezza

Il produttore non è responsabile dei guasti dovuti alle riparazioni effettuate fuori dal suo Servizio Clientela o eseguite da riparatori non autorizzati.

Verifica metrologica

Per tutti gli strumenti di misura e di test, è necessaria una verifica periodica. Vi consigliamo una verifica annuale di questo apparecchio. Vi consigliamo almeno una verifica annuale dello strumento. Per le verifiche e le calibrazioni, rivolgetevi ai nostri laboratori di metrologia accreditati (informazioni e recapiti su richiesta), alla filiale Chauvin Arnoux del Vostro paese o al vostro agente

11. Garanzia

Garanzia

La nostra garanzia è valida, salvo stipulazioni espresse preventivamente, per **dodici mesi** dalla data di vendita del materiale (estratto dalle nostre Condizioni Generali di Vendita disponibili su richiesta).

La garanzia non si applica in seguito a:

- Utilizzo inappropriato dell'attrezzatura o utilizzo con materiale incompatibile,
- Modifiche apportate alla fornitura senza l'autorizzazione esplicita del servizio tecnico del fabbricante,
- Lavori effettuati sullo strumento da una persona non autorizzata dal fabbricante,
- Adattamento ad un'applicazione particolare, non prevista dalla progettazione del materiale o non indicata nel manuale d'uso,
- Danni dovuti ad urti, cadute o a fortuito contatto con l'acqua.

12. Per ordinare

Telemetro laser DM 100 P06237503Z

Consegnato sotto blister con 2 pile (1,5 V LR3), una sacca da trasporto e il presente libretto di funzionamento.

Índice

1. Instrucciones de seguridad	63
2. Puesta en servicio	64
3. Operaciones de configuración inicial	66
4. Medidas	67
5. Funciones	68
6. Especificaciones técnicas	72
7. Problemas de funcionamiento	73
8. Condiciones de medida	74
9. Etiqueta de seguridad	75
10. Verificación	75
11. Garantía	76
12. Estado de entrega	76



ATENCIÓN
RADIACIÓN LÁSER
NO MIRE FIJAMENTE EL HAZ
PRODUCTO LÁSER DE LA CLASE 2

Acaba de adquirir un **Telómetro Láser DM 100** y le agradecemos la confianza que ha depositado en nosotros.

Para obtener las mejores prestaciones de su instrumento:

- **lea** atentamente este manual de instrucciones,
- **respete** las precauciones de uso.

El **Telómetro Láser DM 100** es un instrumento de precisión destinado a la medida de distancias o longitudes con posibilidades de cálculo de superficies o volúmenes.

1. Instrucciones de seguridad

Significado de los símbolos utilizados



¡ATENCIÓN, riesgo de PELIGRO! El operador se compromete en consultar el presente manual cada vez que visualiza este símbolo de peligro.



Radiaciones láser, no mire fijamente el haz LÁSER.



El contenedor de basura tachado significa que, en la Unión Europea, el producto deberá ser objeto de una recogida selectiva de los residuos para el reciclado de los instrumentos eléctricos y electrónicos de conformidad con la directiva DEEE 2002/96/CE.



La marca CE garantiza la conformidad con las directivas europeas sobre "baja tensión" y "compatibilidad electromagnética" (73/23/CEE y 89/336/CEE).

Precauciones de uso

Se debe consultar el presente manual cada vez que encuentre un símbolo de advertencia de peligro. Para evitar radiaciones láser, una herida o dañar este instrumento, y asegurarse de que usted utiliza el telémetro sin riesgo, siga las instrucciones de seguridad a continuación:



No mire fijamente el haz láser. No dirija el haz láser hacia personas.



No utilice el instrumento para un uso diferente al indicado, manténgalo fuera del alcance de los niños y no lo manipule como un juguete.



No oriente el instrumento directamente hacia el sol.

2. Puesta en servicio

Instalar / quitar las pilas

- 1) Quite la tapa de las pilas
- 2) Inserte las pilas respetando la polaridad.
- 3) Vuelva a colocar la tapa de las pilas.
 - Reemplace las pilas cuando el símbolo "  " parpadea de modo permanente en el display.
 - Utilice sólo pilas alcalinas.
 - Quite las pilas si no se va a utilizar el instrumento por un largo período de tiempo.



Teclado

- 1) Tecla Encendido/Medida
- 2) Tecla Superficie/Volumen
- 3) Tecla de Medida indirecta
- 4) Tecla de Medida Puntual/Continua
- 5) Tecla Más (+)
- 6) Tecla Menos (-)
- 7) Tecla Lectura memorias
- 8) Tecla Referencia
- 9) Tecla Retroiluminación y Cambio de unidades
- 10) Tecla Eliminar/Apagado

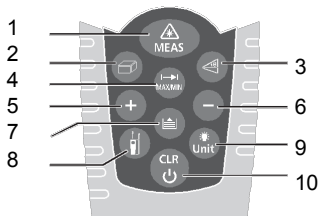

Display LCD

- 1) Láser activo
- 2) Nivel de referencia (frontal)
- 3) Nivel de referencia (parte trasera)
- 4) Función de medida variable



Medida de superficie



Medida de volumen



Medida indirecta



Medida indirecta (2)

- 5) Medida simple de distancia
- 6) Estado de las pilas
- 7) Historial de los registros
- 8) Alerta error instrumento
- 9) Medida continua y valores Máx. y Mín.
- 10) Visualización del primer valor
- 11) Visualización del segundo valor
- 12) Visualización de la última medida o del resultado del cálculo.

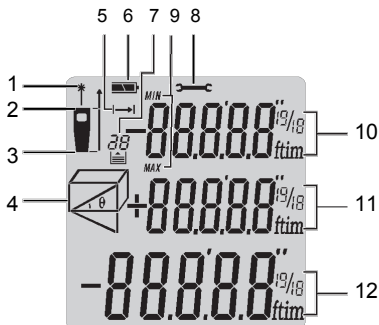

3. Operaciones de configuración inicial

Puesta en marcha y apagado



Pone en funcionamiento el instrumento y enciende el láser.





Al mantener pulsada la tecla, se apaga el instrumento. El instrumento se apaga automáticamente al cabo de 3 minutos de inactividad.

Tecla Eliminar



Se cancela la última acción o borra el valor visualizado. En modo memorización, al pulsar simultáneamente las teclas eliminar y memorización se eliminará la totalidad de los datos memorizados.

Configuración del nivel de referencia

Por defecto, el nivel de referencia se sitúa en la parte trasera del instrumento. Pulse la tecla  para que aparezca la referencia en el frontal .

Una señal acústica indica que la referencia ha sido modificada.

Tras encender el instrumento, el valor por defecto de la referencia vuelve a aparecer automáticamente (parte trasera del instrumento).

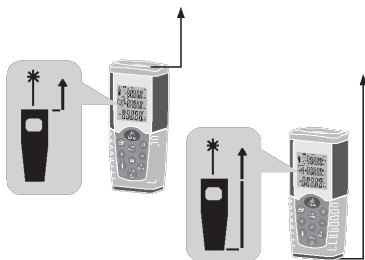

Iluminación del display



Pulse la tecla Retroiluminación / Unidades para encender o apagar la retroiluminación del display LCD.

Programación de las unidades



Mantenga pulsada esta tecla para cambiar las unidades de medida (m, ft., in, ft+in).

4. Medidas

Medida simple de distancia



Pulse una vez esta tecla para activar el láser.

Púlsela dos veces para iniciar la medida. El valor medido aparece inmediatamente.

Medidas continuas (Tracking) y Medidas de Máx. y Mín.

El modo de medidas continuas (tracking) se utiliza para posicionarse a una distancia dada, por ejemplo según las indicaciones de un plano. En modo medidas continuas, el telémetro se puede desplazar respecto al blanco, la medida se actualiza unas dos veces por segundo y aparece en la tercera línea. Los valores mínimos y máximos se indican automáticamente en la primera y segunda línea.

Por ejemplo, el usuario puede desplazarse desde la pared hasta la distancia deseada, ya que se puede leer la distancia actual en continuo. Para entrar en el modo



continuo, pulse  hasta que aparezca la indicación de medida continua en el display. Pulse la tecla MEAS o la tecla eliminar para salir de la función. La función se para automáticamente después de 100 medidas consecutivas.

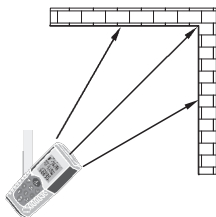
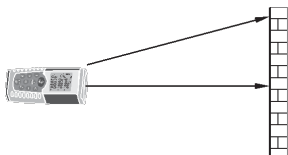

5. Funciones

Suma / Sustracción

Medir una distancia:



La medida siguiente se suma a la medida anterior.



La medida siguiente se resta a la medida anterior.





La última operación se cancela.



Volver al modo de medida simple de distancia.

Medida de superficie

Pulse la tecla Superficie / Volumen, el símbolo  aparecerá en pantalla.

Pulse  para visualizar la primera medida (por ejemplo la longitud).

Pulse  otra vez para visualizar la segunda medida (por ejemplo la anchura).

El resultado del cálculo de la superficie se indica en la tercera línea. En cuanto a las medidas individuales, aparecen en las líneas 1 y 2.

Medidas de volumen

Pulse 2 veces la tecla Superficie / Volumen para las medidas de volumen, el símbolo  aparecerá en pantalla.



Pulse esta tecla para realizar la primera medida (por ejemplo la longitud).



Púlsela para tomar la segunda distancia (por ejemplo la anchura). El resultado del cálculo de la superficie obtenido gracias a estas medidas aparece entonces en la línea 3.





Púlsela para tomar la tercera medida (por ejemplo la altitud). Se indica su valor en la segunda línea.

El resultado del cálculo del volumen se indica en la tercera línea.

Medidas indirectas

Las medidas indirectas consisten en determinar una distancia utilizando dos medidas auxiliares.

Por ejemplo, la medida de una altura puede efectuarse midiendo las dos demás distancias.

Pulse el botón  , aparecerá el símbolo  en pantalla. La distancia a medir parpadea en el símbolo.



Apunte el punto alto (medida 1) y valide la medida.

Después de obtener la primera medida, ponga el instrumento en la posición más horizontal posible.



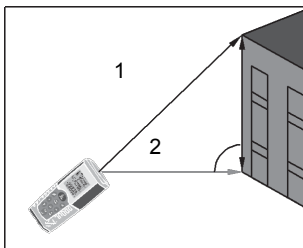

Pulse esta tecla para realizar la medida del punto horizontal (medida 2).

El resultado del cálculo se indica en la tercera línea del display.



Medidas indirectas – Determinar una distancia con 3 medidas

Pulse dos veces ; aparecerá el siguiente símbolo en el display: 

La distancia a medir parpadea en el símbolo.



Apunte el punto bajo (1) y valide la medida. Una vez adquirida esta primera medida, coloque el instrumento en posición horizontal.



Pulse esta tecla para obtener la distancia en el punto horizontal (2). Apunte luego el punto alto.



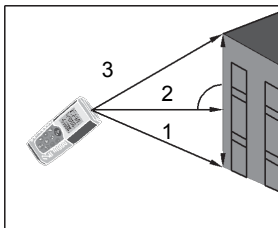

Pulse esta tecla para obtener la distancia en el punto alto (3).

El resultado del cálculo se indica en la tercera línea del display.



Memorización



Los 20 últimos datos guardados (medidas o cálculos) se almacenan en orden inverso. Utilice las teclas   para visualizar estos registros.

Se pueden borrar todos los datos guardados pulsando simultáneamente las teclas Registro y Eliminar.

6. Especificaciones técnicas

Especificaciones técnicas

Especificaciones técnicas	Modelo: DM 100
Distancia medible	de 0,05 a 50 m* (de 0,16 ft a 164 ft*)
Incertidumbre de medida hasta 10 m (2 σ , desviación estándar)	Típica $\pm 1,5$ mm** ($\pm 0,06$ in**)
Unidades de medida	m, in, ft
Clase del láser	Clase 2 – EN 60825-1
Características del láser	630 nm – 670 nm, < 1 mW
Cálculos de superficies y volúmenes	sí
Medidas indirectas (Pitágoras)	sí
Suma / Sustracción	sí
Medidas continuas	sí
Búsqueda de distancia Mín./Máx.	sí
Retroiluminación y display multilíneas	sí
Indicador acústico	sí
Protección	IP 54
Profundidad de memoria	20
Tipo de teclado	Larga duración
Temperatura de funcionamiento	de 0°C a 40°C (de 32°F a 104°F)
Temperatura de almacenamiento	de - 10°C a 60°C (de 14°F a 140°F)
Autonomía de las pilas	Hasta 4.000 medidas
Pilas	2 x 1,5 V (LR3, AAA)
Autoapagado del láser	Después de 0,5 min
Autoapagado del instrumento	Después de 3 min
Dimensiones	115 x 48 x 18 mm
Peso	135 g
Compatibilidad electromagnética	EN 61326-1

* Utilice una placa blanco para aumentar el rango de medida si la zona apuntada presenta reducidas propiedades de reflexión.

** En condiciones favorables.

En caso de condiciones desfavorables, este valor puede incrementarse de $\pm 0,15$ mm / m ($\pm 0,0018$ in / ft) más allá de 10 metros.

7. Problemas de funcionamiento

Problemas de funcionamiento

Código	Causa	Medida correctiva
204	Error de cálculo	Reitere el proceso
208	Señal recibida demasiado débil, el tiempo de medida es demasiado largo. Distancia > 50 m	Utilización de una placa blanco para mejorar la reflexión.
209	Señal recibida demasiado fuerte	El punto apuntado es demasiado reflectante, utilice un blanco menos reflectante.
252	Temperatura demasiado alta	Colocar el instrumento en un lugar templado.
253	Temperatura demasiado fría	Colocar el instrumento en un lugar templado.
255	Error material	Apague y encienda el instrumento varias veces. Si el defecto persiste, contacte a su vendedor.

8. Condiciones de medida

Rango de medida

La distancia medible está limitada a 50 metros.

Al anochecer o de noche, si el blanco se encuentra en la sombra, la distancia medible sin el uso de placa blanco se incrementa.

Utilice una placa blanco para aumentar la distancia medible durante medidas realizadas de día o si la zona de medida presenta reducidas propiedades de reflexión óptica.

Superficies apuntadas

Se pueden producir errores de medida si ésta se realiza hacia líquidos transparentes (ej. agua), vidrio sin impureza, poliestireno o materiales semipermeables similares. Apuntar hacia superficies barnizadas puede desviar el haz láser y conducir a errores de medida. El tiempo de medida puede aumentar si se apunta a superficies no-reflectantes o negras.

Precauciones

No sumerja el instrumento en agua. Para quitar el polvo acumulado en la parte óptica, utilice un paño suave y húmedo. Para la carcasa, no utilice agentes de limpieza agresivos, sino agua y jabón. Las precauciones a tomar son las mismas que para cualquier instrumento óptico (telescopio, cámara de fotos, etc.).

9. Etiqueta de seguridad

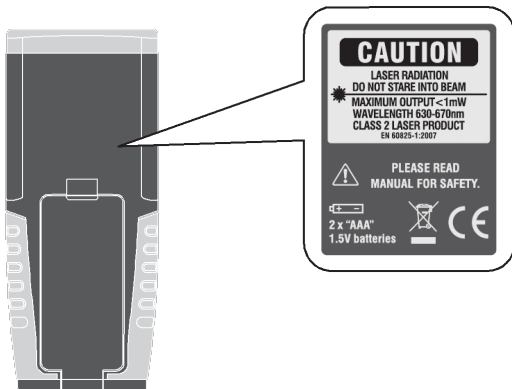

ATENCIÓN
RADIACIÓN LÁSER
NO MIRE FIJAMENTE EL HAZ
PRODUCTO LÁSER DE LA CLASE 2

10. Verificación

Aviso de seguridad

El fabricante no se hará responsable de cualquier accidente que pudiera derivarse de una reparación o modificación no realizada por su servicio postventa o por reparadores autorizados.

Verificación metroológica

Al igual que todos los instrumentos de medida o de prueba, es necesario realizar una verificación periódica. Le aconsejamos una verificación anual de este instrumento. Para las verificaciones y calibraciones, contacte con nuestros laboratorios de metrología acreditados (solicítenos información y datos), con la filial Chauvin Arnoux o con el agente de su país.

11. Garantía

Garantía

Nuestra garantía tiene validez, salvo estipulación expresa, durante **doce meses** a partir de la fecha de entrega del material. Extracto de nuestras Condiciones Generales de Venta, comunicadas a quien las solicite.

La garantía no se aplicará en los siguientes casos:

- Uso inapropiado del instrumento o su uso con un material incompatible,
- Modificaciones realizadas en el instrumento sin la autorización explícita del servicio técnico del fabricante,
- Una persona no autorizada por el fabricante ha realizado operaciones sobre el instrumento,
- Adaptación para una aplicación especial, no prevista por la definición del material o no indicada en el manual de instrucciones,
- Daños debidos a golpes, caídas o inundaciones.

12. Para pedidos

Telómetro láser DM 100 P06237503Z

suministrado en blíster con 2 pilas 1,5 V LR3, una bolsa de transporte y el presente manual de instrucciones.