

**FLUKE®**

# **709/709H/710**

Precision Loop Calibrator

Users Manual

January 2013 Rev. 1 10/18

©2013-2018 Fluke Corporation. All rights reserved.

All product names are trademarks of their respective companies.

Specifications are subject to change without notice.

## LIMITED WARRANTY AND LIMITATION OF LIABILITY

This Fluke product will be free from defects in material and workmanship for three years from the date of purchase. This warranty does not cover fuses, disposable batteries, or damage from accident, neglect, misuse, alteration, contamination, or abnormal conditions of operation or handling. Resellers are not authorized to extend any other warranty on Fluke's behalf. To obtain service during the warranty period, contact your nearest Fluke authorized service center to obtain return authorization information, then send the product to that Service Center with a description of the problem.

THIS WARRANTY IS YOUR ONLY REMEDY. NO OTHER WARRANTIES, SUCH AS FITNESS FOR A PARTICULAR PURPOSE, ARE EXPRESSED OR IMPLIED. FLUKE IS NOT LIABLE FOR ANY SPECIAL, INDIRECT, INCIDENTAL OR CONSEQUENTIAL DAMAGES OR LOSSES, ARISING FROM ANY CAUSE OR THEORY. Since some states or countries do not allow the exclusion or limitation of an implied warranty or of incidental or consequential damages, this limitation of liability may not apply to you.

Fluke Corporation  
P.O. Box 9090  
Everett, WA 98206-9090  
U.S.A.

Fluke Europe B.V.  
P.O. Box 1186  
5602 BD Eindhoven  
The Netherlands

ООО «Флюк СИАЙЭС»  
125167, г. Москва, Ленинградский  
проспект дом 37,  
корпус 9, подъезд 4, 1 этаж

# Table of Contents

Title	Page
Introduction . . . . .	1
How to Contact Fluke . . . . .	2
Safety Information . . . . .	2
Symbols . . . . .	3
Standard Equipment . . . . .	4
The Product . . . . .	6
The Buttons . . . . .	6
The Selection Knob . . . . .	7
Language Selection . . . . .	7
Main Menu . . . . .	7
mA Source . . . . .	8
mA Simulate . . . . .	9
mA Measure . . . . .	10
mA Measure with 24V . . . . .	11
Volts Measure . . . . .	12
Calibrator Setup Menu . . . . .	12
Auto Ramp Time . . . . .	13
Auto Step Time . . . . .	13
Step and Ramp Operation . . . . .	13
Automatic Step and Ramp . . . . .	14
Valve Test . . . . .	14
HART 250 $\Omega$ Resistor . . . . .	15
Valve Test Parameters . . . . .	15

mA Span . . . . .	15
Contrast . . . . .	15
Auto Shutdown Time . . . . .	16
HART Write Enable . . . . .	16
HART Device Communication . . . . .	17
HART Connections . . . . .	18
In Circuit, External Loop Power . . . . .	18
In Circuit, Product Loop Power . . . . .	19
Across Circuit, Communicator Only . . . . .	20
Communications Setup and Selection . . . . .	21
Mode . . . . .	21
250Ω Resistor . . . . .	22
HART Connect . . . . .	22
Polling Loop . . . . .	22
Tag Selection . . . . .	23
Acquiring Data . . . . .	23
Disconnect from Loop . . . . .	24
Function Select Menu . . . . .	24
Display Setup and Data . . . . .	24
Write LRV and URV Values . . . . .	25
Write LRV . . . . .	25
Write URV . . . . .	26
Write PV Unit . . . . .	26
Modify Tags, Msg, Descr . . . . .	27
Trim, Set, and Zero Menu . . . . .	28
Trim 4 mA . . . . .	28
Trim 20 mA . . . . .	29
Set Fixed mA Output . . . . .	29
PV Zero . . . . .	30
Device Diagnostic . . . . .	30
Configuration Log and Data Log . . . . .	31
Configuration Log . . . . .	31
Data Log . . . . .	32
Valve Tests (710) . . . . .	34
Signature Test . . . . .	35
Manual Test . . . . .	35
Speed Test . . . . .	36
Step Test . . . . .	37
Bump/Partial Test . . . . .	37

Test Configuration Screens .....	38
HART Comms Menu.....	38
Valve Test Quick Start Guide .....	39
Maintenance .....	40
Clean the Product.....	40
Fuse .....	40
Battery Replacement .....	40
User-Replaceable Parts .....	41
Specifications.....	42



## Introduction

The Fluke 709 Precision Loop Calibrator and 709H Precision HART Loop Calibrator (the Product or the Calibrator) can be used for installation, calibration, and troubleshooting of field transmitters, valves, and other control system components at process plants. Primary functions are source and measure mA signals in the 0 mA to 24 mA range. The Product can also produce 24 V dc loop power.

The 709H includes HART communication functionality and supports a select set of HART universal and common-practice commands. The Product can be used as a loop calibrator or basic function communicator.

The 710 has all the functions of the 709H plus test functions for HART smart control valves.

Table 1 is a list of features available by model number.

**Table 1. Model Features**

Feature	709	709H	710
Current measurement, sourcing, and a selectable 24 V supply	●	●	●
30 V dc measurement	●	●	●
Valve test capability	●	●	●
Output step and ramp	●	●	●
Large backlight display	●	●	●
Digital selection knob with selectable decade control for easy data entry	●	●	●
Interactive menus	●	●	●
Selectable English or German user interface	●	●	
A selectable HART 250 Ω loop resistor		●	●
Communicator mode reads basic device information, does diagnostic tests, and can be used to trim the 4-20 mA output of most HART-enabled transmitters.		●	●
Supports test functions for HART smart control valves			●

## How to Contact Fluke

To contact Fluke, call one of the following telephone numbers:

- Technical Support USA: 1-800-44-FLUKE (1-800-443-5853)
- Calibration/Repair USA:
  - 1-888-99-FLUKE (1-888-993-5853)
- Canada: 1-800-36-FLUKE (1-800-363-5853)
- Europe: +31 402-675-200
- Japan: +81-3-6714-3114
- Singapore: +65-6799-5566
- China: +86-400-921-0835
- Brazil: +55-11-3530-8901

Anywhere in the world: +1-425-446-5500

Or, visit Fluke's website at [www.fluke.com](http://www.fluke.com).

To register your product, visit <http://register.fluke.com>.

To view, print, or download the latest manual supplement, visit <http://us.fluke.com/usen/support/manuals>.

## Safety Information

A **Warning** identifies hazardous conditions and procedures that are dangerous to the user. A **Caution** identifies conditions and procedures that can cause damage to the Product or the equipment under test.

### Warning

To prevent possible electrical shock, fire, or personal injury:

- Read all safety information before you use the Product.
- Use the Product only as specified, or the protection supplied by the Product can be compromised.









- Examine the case before you use the Product. Look for cracks or missing plastic. Carefully look at the insulation around the terminals.
- Do not use test leads if they are damaged. Examine the test leads for damaged insulation and measure a known voltage.
- Do not use and disable the Product if it is damaged.
- Do not use the Product around explosive gas, vapor, or in damp or wet environments.
- Do not touch voltages >30 V ac rms, 42 V ac peak, or 60 V dc.
- Do not apply more than the rated voltage, between the terminals or between each terminal and earth ground.
- Do not connect directly to mains.
- Do not exceed the Measurement Category (CAT) rating of the lowest rated individual component of a Product, probe, or accessory.
- Keep fingers behind the finger guards on the probes.
- Remove all probes, test leads, and accessories before the battery door is opened.
- Remove the batteries if the Product is not used for an extended period of time, or if stored in temperatures above 50 °C. If the batteries are not removed, battery leakage can damage the Product.
- Replace the batteries when the low battery indicator shows to prevent incorrect measurements.
- The battery door must be closed and locked before you operate the Product.



## Symbols

Table 2 is a list of symbols used on the Product or in this manual.

**Table 2. Symbols**

Symbol	Description	Symbol	Description
	WARNING - RISK OF DANGER. Consult user documentation.		Conforms to relevant South Korean EMC Standards.
	Earth		Conforms to relevant Australian EMC standards.
	Battery		Certified by CSA Group to North American safety standards.
	Conforms to European Union directives.		
	This product complies with the WEEE Directive marking requirements. The affixed label indicates that you must not discard this electrical/electronic product in domestic household waste. Product Category: With reference to the equipment types in the WEEE Directive Annex I, this product is classed as category 9 "Monitoring and Control Instrumentation" product. Do not dispose of this product as unsorted municipal waste.		

## Standard Equipment

Table 3 is a list of items included with the Product. See Figure 1 for details.

**Table 3. Standard Equipment**

Item	Description	709	709H	710
①	Two AC72-1 alligator clips	●		
②	TL-75-4201 test leads	●		
③	754-8016 alligator clip set		●	●
④	75X-8014 stackable lead set		●	●
⑤	TP220-4201 test probes		●	●
⑥	AC280-5001 Suregrip hook clips		●	●
⑦	USB to 5-pin Lemo Cable, 6-ft (1.8 m)			●
⑧	Soft Case	●	●	●
Not Shown	Six IEC LR03 batteries (installed)	●	●	●
	Quick Reference Guide	●	●	●
	Safety Information	●	●	●

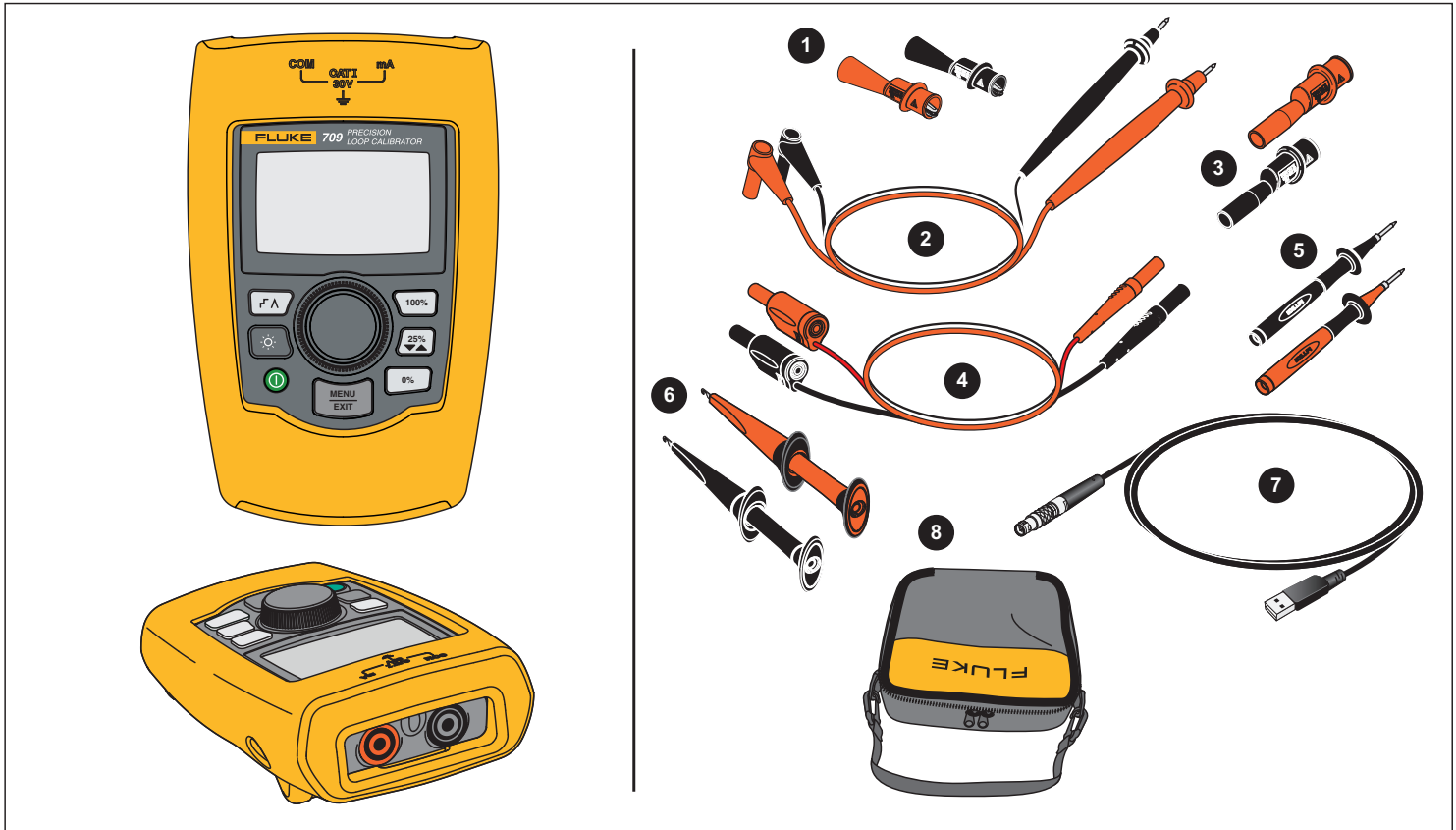

Figure 1. Standard Equipment

## The Product

The subsequent sections are about the features and functions of the Product.

### The Buttons

Figure 2 and Table 4 show the location and brief descriptions of the Product buttons.



Figure 2. Button Locations





Table 4. Button Descriptions

Button	Function
	Push to enable step, ramp, or start valve tests.
	Push to turn on or turn off the backlight.
	Push to turn on and turn off the Product.
	Push to set the output to 20 mA when in mA Source or mA Simulate modes. In Measurement mode the button does not set the output current.
	Push to step the output up or down by 25 % increments (4, 8, 12, 16, 20 mA).
	When valve test is enabled, push to step the output as 3.8, 4, 4.2, 8, 12, 16, 19.8, 20, and 20.2 mA.
	Push to set the output to 4 mA when in mA Source or mA Simulate mode. In Measurement mode the button does not set the output current.
	Push to enter the Main menu. Push a second time to exit the Main menu. See <i>Main Menu</i> .

## The Selection Knob

The selection knob lets you select and control functions and navigate through the Product menus. Turn the selection knob to highlight a menu item or adjust a value. When the item is highlighted, push the selection knob to do the selected action, or push and hold to save any changes that have been made. Push  to go to the main screen with no action.



In the output modes (mA Source, mA Simulate):

- Push the selection knob to move the display cursor to the next digit.
- Turn the selection knob to increment or decrement the output in steps shown by the selected decade.
- Push , , or  to set the output to preset values.
- Push  to select and stop these advanced modes.

## Language Selection

For the 709/709H models, the user interface language is available in English or German.

To change:

1. Turn off the Product.
2. Simultaneously push and hold  and  as you turn on the Product.
3. At the prompt, use the selection knob to highlight the language choice.
4. Push the selection knob to accept the choice.

## Main Menu

Push  to show the Main menu, choose the primary operation mode of the Product, access the Product setup menu, or to use HART mode. See Figure 3.

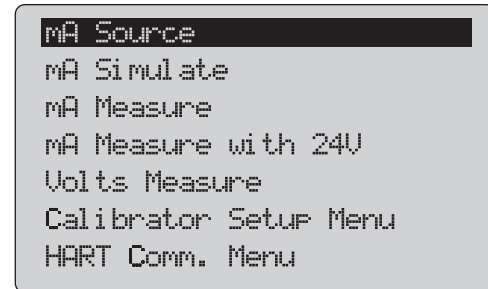

Figure 3. Main Menu

The first five items that show on the Main menu change the Product operation mode accordingly and once selected, change the Product menu to a **Home** screen for the selected function. The operation modes are explained in the subsequent sections of this manual.

For the last two items of the Main menu, see *Calibrator Setup Menu* and *HART Comm. Menu*.

### Note

*The HART menu items only apply to the 709H and 710.*

*Some menus have multiple screens. In this case, the lower-left corner of the menu shows ▼ when additional screens follow the current screen. ▲ shows when additional screens precede the current screen. Both icons show when additional screens follow and precede the present screen.*

## **mA Source**

In the **mA Source** mode, the Product outputs a signal from 0 mA to 24 mA into a load of up to 1200  $\Omega$  (950  $\Omega$  if the internal HART resistor is switched on).

Figure 4 shows the **mA Source** home screen and typical connections for this mode.

To use mA Source:

1. Select mA Source from the Main menu.
2. Push the selection knob to move the decade cursor.
3. Turn the selection knob to increment or decrement the output in steps indicated by the selected decade.
4. Push , , or  to set the output to preset values.
5. Push  to select and stop these advanced modes. When automatic step or ramp is active, one of the subsequent icons show in the lower left corner:  
Automatic step: r<sup>^</sup>  
Automatic ramp:  $\wedge$

6. Push  to go to the Main menu.
7. Push  again to go to the mA Source home screen.
  - **Valve Test** shows in the lower center when the valve test function has been enabled on the Setup menu. See the *Valve Test*.
  - **250 $\Omega$**  shows in the lower right corner when the HART resistor has been enabled on the setup menu.

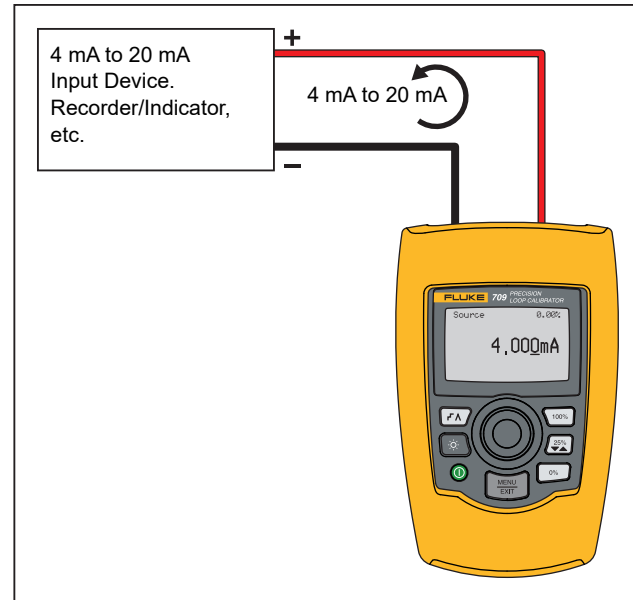

**Figure 4. mA Source Connections**

## **mA Simulate**

In the **mA Simulate** mode, the Product functions like a 2-wire transmitter and controls the loop current from an external power supply. This function can test a loop with the transmitter removed.

Figure 5 shows the **mA Simulate** home screen and typical connections for this mode.

To use mA Simulate:

1. Select mA Simulate from the Main menu.
2. Push the selection knob to move the decade cursor.
3. Turn the selection knob to increment or decrement the output in steps indicated by the selected decade.
4. Push , , or  to set the output to preset values.
5. Push  to select and stop these advanced modes. When automatic step or ramp is active, one of the subsequent icons shows in the lower left corner:
  - Automatic step: r
  - Automatic ramp: Λ
6. Push  to go to the Main menu.
7. Push  again to go to the mA Simulate home screen.
  - **Valve Test** shows in the lower center when the valve test function has been enabled on the Setup menu. See the *Valve Test*.
  - **250Ω** shows in the lower right corner when the HART resistor has been enabled on the setup menu.

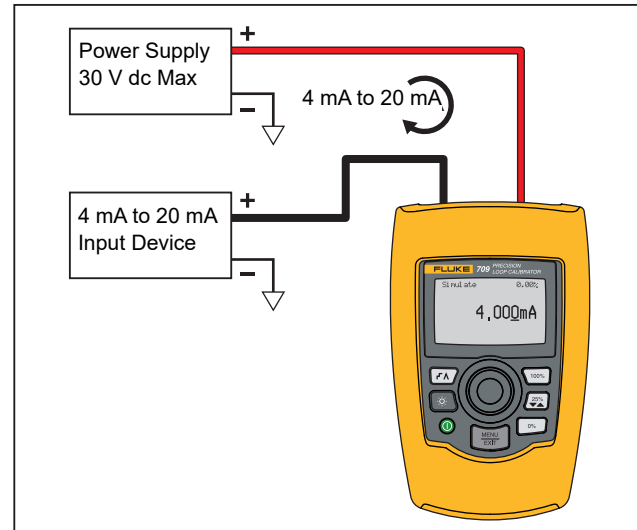

**Figure 5. mA Simulate Connections**

### **mA Measure**

In the **mA Measure** mode, the Product shows the loop current measurement. This mode is without 24 V.

Figure 6 shows the mA Measure home screen and typical connections for this mode.

To use mA Measure, select mA Measure from the Main menu. When selected, the Product changes to the mA Measure home screen.

**250Ω** shows in the lower right corner when the HART resistor is enabled on the setup menu.

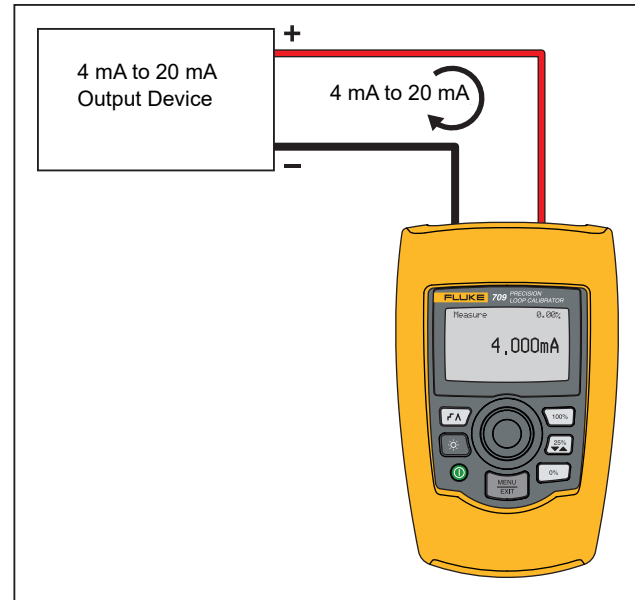

**Figure 6. mA Measure Connections**



### **mA Measure with 24V**

In the **mA Measure with 24V** mode, the Product outputs 24 V dc as it shows the loop current. This mode powers a transmitter without a separate power supply.

Figure 7 shows the home screen and typical connections for this mode.

To use mA Measure with 24V, select **mA Measure with 24V** from the Main menu. When selected, the Product changes to the mA Measure with 24V home screen. **250Ω** shows in the lower right corner when the HART resistor is enabled on the setup menu.

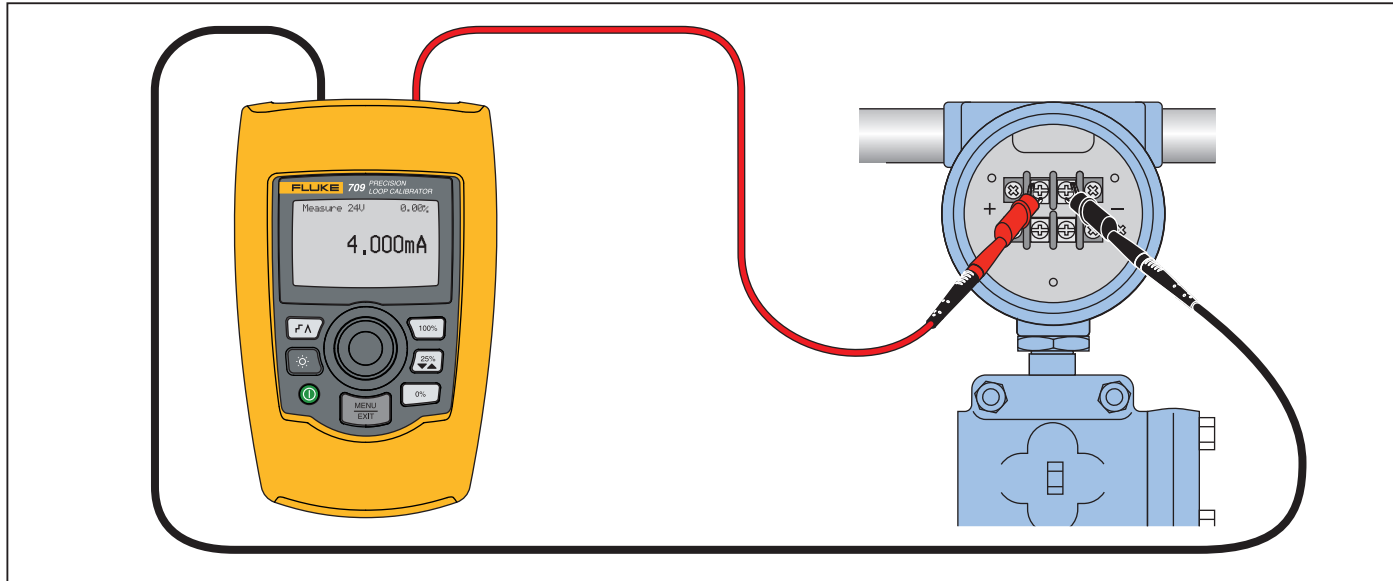

Figure 7. mA Measure with 24 V Connections

## Volts Measure

In the **Volts Measure** mode, the Product shows the loop voltage. Figure 8 shows the Volts Measure home screen and typical connections for this mode.

To use the Volts Measure mode, select **Volts Measure** from the Main menu. When selected, the Product changes to the Volts Measure home screen.

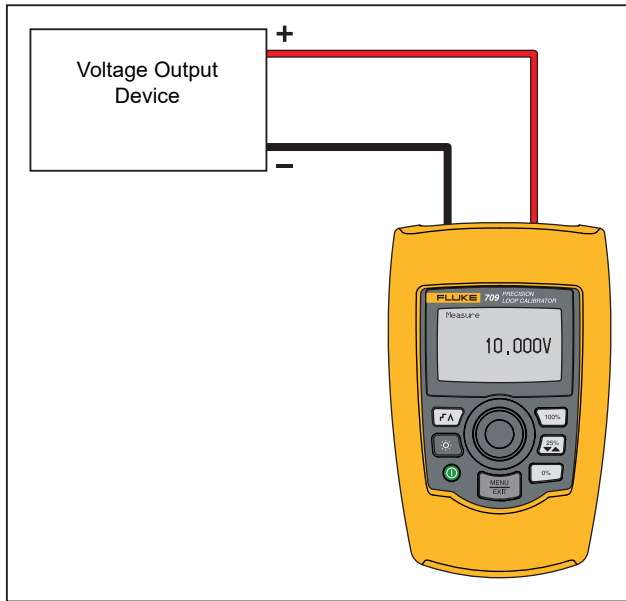

Figure 8. Volts Measure Connections

## Calibrator Setup Menu

The **Calibrator Setup Menu** has two screens. To go to the second screen, select **Other Parameters** from the first screen. Screen 1 shows in Figure 9 and screen 2 shows in Figure 10.

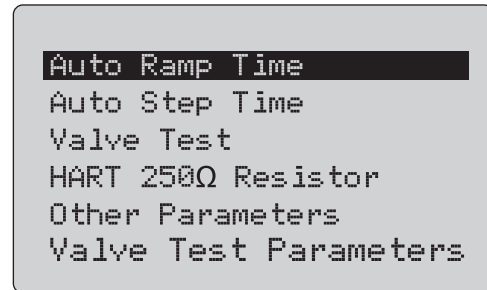

Figure 9. Setup Menu, Screen 1

*Note*

*The **Valve Test Parameters** menu item only shows on the 710.*

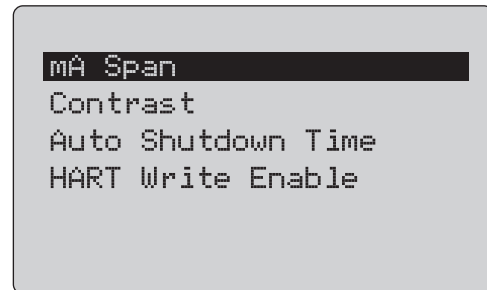

Figure 10. Other Parameters Menu, Screen 2

*Note*

*The **HART Write Enable** menu item only shows on the 709H and 710.*

### Auto Ramp Time

The **Auto Ramp Time** function sets the full-scale ramp time for the mA ramp feature. The value can be set from 5 seconds to 300 seconds. Push the selection knob to move the decade cursor. Turn the selection knob to adjust the value in steps indicated by the decade selected. See Figure 11.

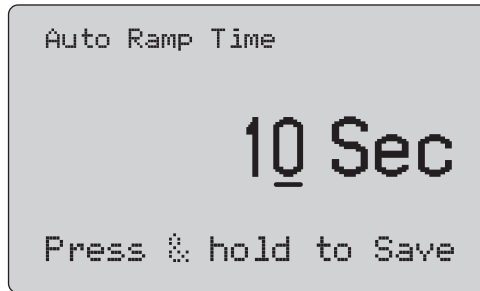

Figure 11. Auto Ramp Time Screen

#### Note

*The ramp time setting also changes the ramp time for the valve tests.*

### Auto Step Time

The **Auto Step Time** function sets the step interval time for the mA Auto Step feature. The value can be set from 5 seconds to 300 seconds. Push the selection knob to move the decade cursor. Turn the selection knob to adjust the value in steps indicated by the decade selected. See Figure 12.



Figure 12. Auto Step Time Screen

### Step and Ramp Operation

For step and ramp operation, the percent keys can be used to set the milliamp output to 0 % of span, 100 % of span, or step the output by 25 % of span.

Hands-free operation is possible with  $\overline{F\Delta}$ . Set the Product to automatically and continuously step or ramp the milliamp output from 0 % to 100 % and back.

The 100 % value is always 20 mA, but the 0 % value can be 0 mA or 4 mA. This depends on how the mA span is set. The 25 % step size is 5 mA or 4 mA accordingly.

To use the manual step function:

1. Use the Main menu to set the Product to source or simulate current.
2. Push  $\overline{0\%}$  to set the output to 0 % of span.
3. Push  $\overline{100\%}$  to set the output to 100 % of span.
4. Push  $\overline{25\%}$  to step the output in 25 % of span increments, from 0 % of span to 100 % of span and back.

## Automatic Step and Ramp

To use the automatic step and automatic ramp functions:

1. Use the Main menu to set the Product to source or simulate current.
2. The Product has separate auto ramp and step times. Use the menu to set the ramp or step time.
3. Push **[FΛ]** once to continually step the output from 0 % of span to 100 % of span and back in increments of 25 % of span at the specified interval.
4. Push **[FΛ]** once more to go to auto ramp.
5. Push one of the percent keys, and **[FΛ]** twice, to turn off the auto step and ramp.
6. Push **[FΛ]** twice to continually ramp the output from 0 % of span to 100 % of span over the specified interval, and then back over the specified interval.
7. Push one of the percent keys or **[FΛ]** once more, to turn off the auto step and ramp.

## Valve Test

The **Valve Test** function turns on or off the valve test feature. See Figure 13.

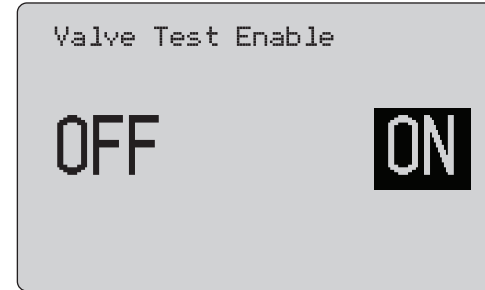

Figure 13. Valve Test Enable Screen

The valve test verifies correct operation of valves. In valve test, the output can be stepped to these values:

- 3.8 mA
- 4.0 mA
- 4.2 mA
- 8.0 mA
- 12.0 mA
- 16.0 mA
- 19.8 mA
- 20.0 mA
- 20.2 mA

The valve test mA values are not affected by the mA span setting.

1. Use the Main menu to set the Product to source or simulate current.
2. If valve test is not enabled, use the menu to enable it.
3. Push **[FΛ]** or **[25%]** to step the output to verify the proper valve operation.
4. Use the menu to disable valve test when done.

### HART 250 $\Omega$ Resistor

The **HART 250 $\Omega$  Resistor Enable** function turns on and turns off the HART resistor. See the *HART Resistor*. See Figure 14.

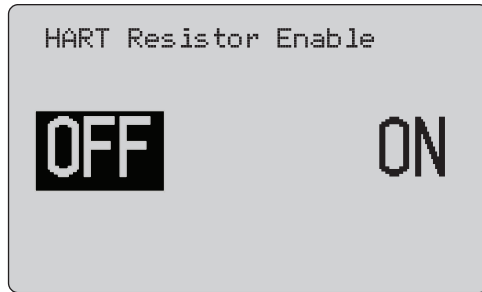

Figure 14. HART Resistor Enable Screen

The Product can insert a 250  $\Omega$  resistor in series with the power supply in order to use a HART communicator. The HART resistor is enabled through the menu.

To get to the second Calibrator Setup Screen, highlight **Other Parameters** and push the selection knob.

### Valve Test Parameters

Use the **Valve Test Parameters** menu to set the 710 parameters to match the valve parameters (for example, PV, SV, TV, and QV).

This menu also sets the default test tolerances for all test templates.

### mA Span

**mA Span** is the first item on the second Calibrator Setup Menu.

The mA Span function sets the step interval for the mA Auto Step feature. The value can be set from 5 seconds to 300 seconds. See *Step and Ramp Operation*. See Figure 15.



Figure 15. mA Span Selection Screen

### Contrast

The **Contrast** function adjusts the display contrast. Turn the selection knob to adjust the contrast. The range shows by the bar graph. Higher contrast shows by a longer bar. The sample normal and reverse video selections let you evaluate both text modes. See Figure 16.

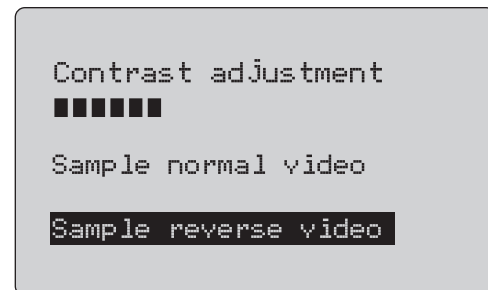

Figure 16. Contrast Adjustment Screen

### Auto Shutdown Time

The **Auto Shutdown Time** function sets or turns off the time before the Product automatically shuts itself down if the keypad is not used. The value can be set to Disabled, or from 1 minute to 30 minutes. See Figure 17.



Figure 17. Auto Shutdown Screen

### HART Write Enable

**HART Write Enable** is the last function in the Calibrator Setup Menu. See Figure 18.

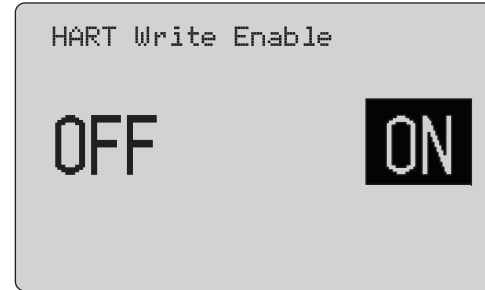



Figure 18. Hart Write Enable Screen

This function is available only on the 709H and 710. It protects the Write LRV, Write URV, Device Diagnostic, Trim 4mA, Trim 20mA, Set Fixed Output, and PV Zero functions. The default setting is **ON**, but it may be turned off to protect the Product against unauthorized use.

Before the setting is changed, a password is required. The password is set to 617 at the factory. The range of values that can be set is 000 to 999. See Figure 19.

The write-enable selection is saved only when the correct password is given. Otherwise an error message shows.

Push the selection knob to move the decade cursor. Turn the selection knob to adjust the value in steps indicated by the decade selected. Push and hold the selection knob to save the write enable setting. Push  to restore the previous HART-enable selection and go to the Main screen.

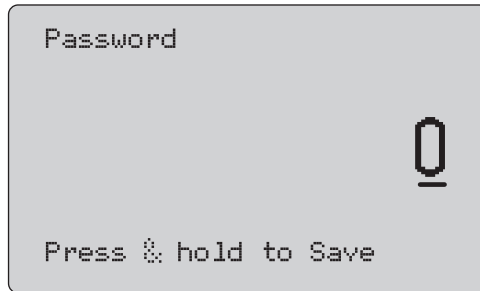

**Figure 19. Password Screen**

## **HART Device Communication**

The HART functions are only available in the 709H and 710.

Auto shutdown is disabled when the HART menus are used. Auto shutdown is restored to its previous state when you exit the HART menus.

### *Note*

*Loop current trim is supported for transmitter devices, but is not supported for actuator devices.*

These functions can be disabled with the HART Write Enable selection on the Product:

- write LRV
- write URV
- write PV unit
- device diagnostic
- auto trim (710 only)
- trim 4 mA
- trim 20 mA
- set fixed mA output
- PV zero
- modify Tags, Msg, Description

The 710 uses additional HART commands to execute the Signature, Step, Speed, and Bump/Partial Stroke tests.

PV zero functions can be disabled with the HART Write Enable selection on the Calibrator Setup menu. See *Calibrator Setup Menu*. If these functions are required, they must be enabled before you enter the HART menus.

## HART Connections

See the subsequent sections for HART connections.

### In Circuit, External Loop Power

In **mA Measure** mode, the Product is in circuit and loop power is supplied externally. In Figure 20, the 250 HART resistor is enabled. If the loop already has 250  $\Omega$ , do not enable the HART resistor.

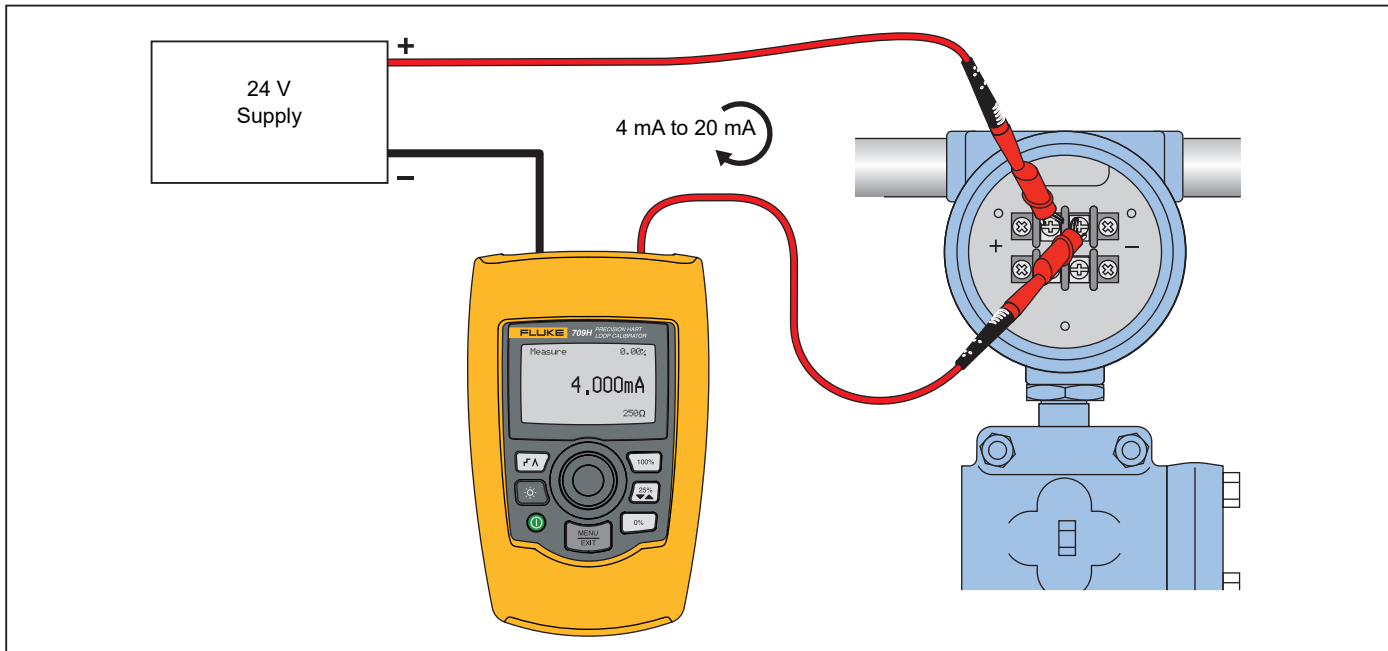

Figure 20. In Circuit, External Loop Power Connections



*In Circuit, Product Loop Power*

In **mA Measure with 24V** mode, the Product is in circuit and loop power is supplied by the Product. In Figure 21, the 250  $\Omega$  HART resistor is enabled. If the loop already has 250  $\Omega$ , do not enable the HART resistor.

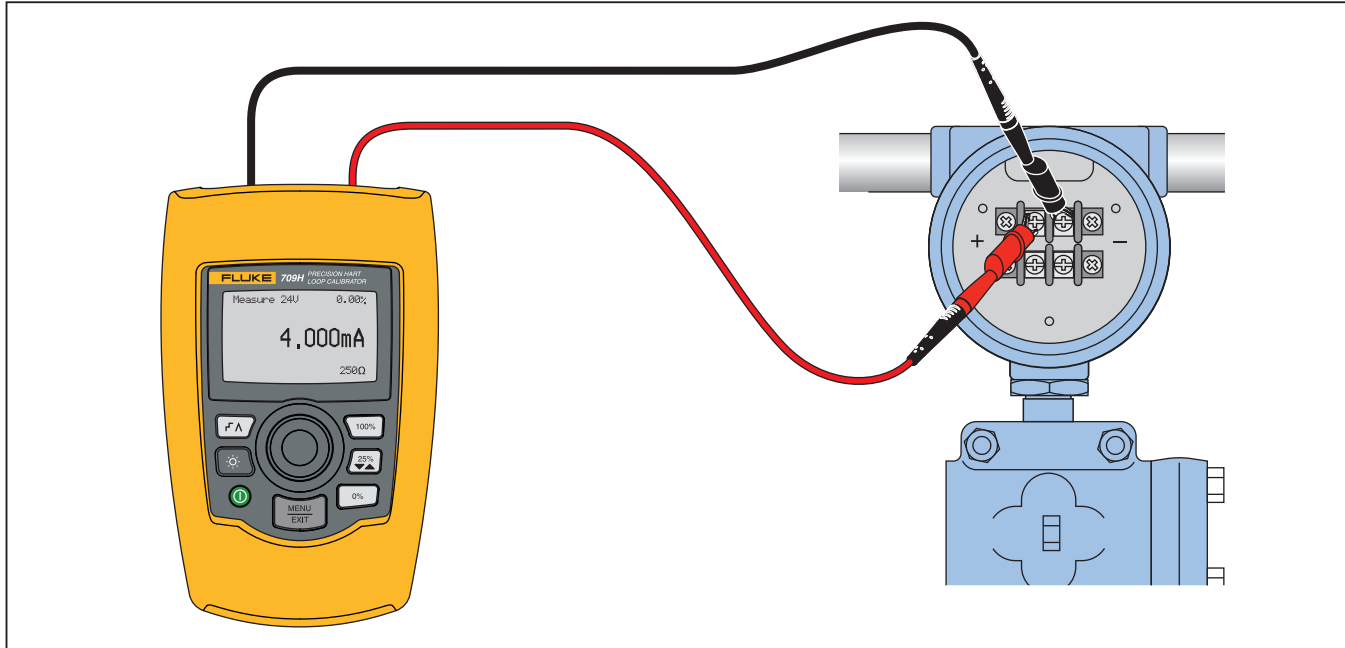
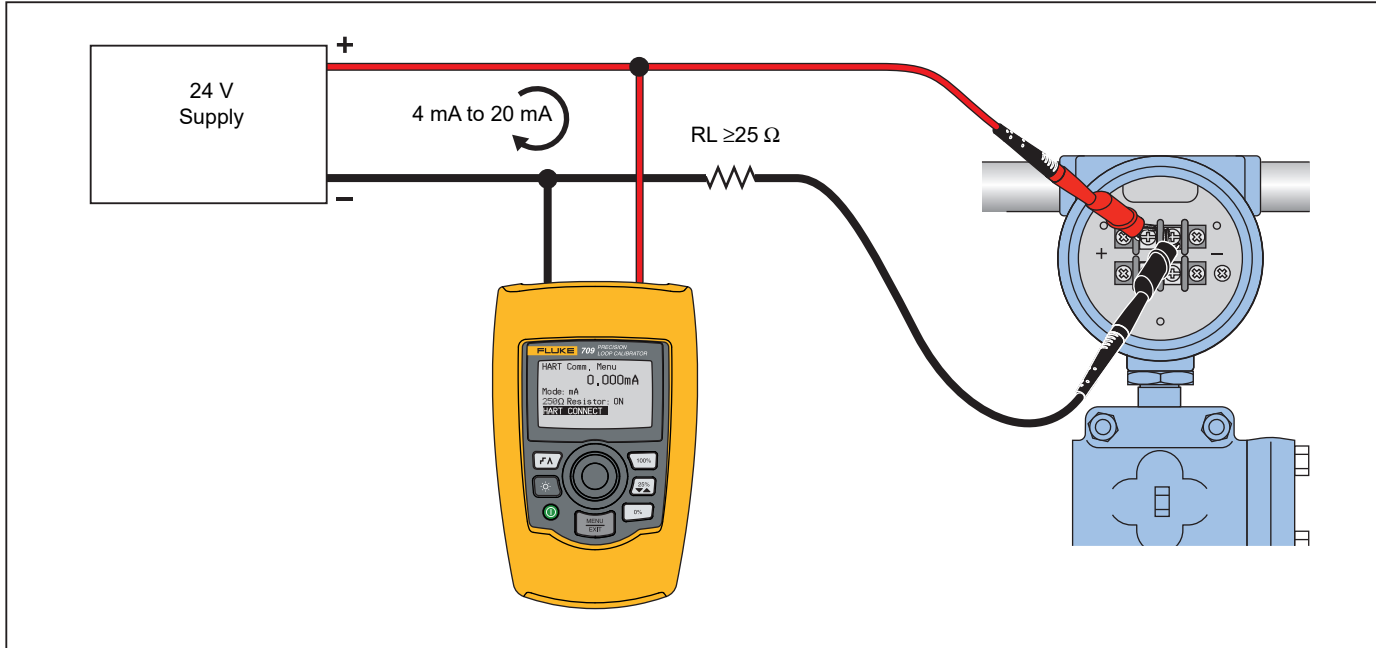

Figure 21. In Circuit, 709H Loop Power

*Across Circuit, Communicator Only*

In **Communicator Only** mode, the Product is across the circuit and loop power is supplied externally. In Figure 22, when in Communicator Only mode, there must be  $250\ \Omega$  resistance present in the loop.



**Figure 22. Across Circuit, Communicator Only Connections**

### Communications Setup and Selection

For all Main screen operation modes, except **mA Measure with 24V** or **Volts Measure**, the operation mode is set to **mA Measure** when you enter the **HART Comm. Menu**.

The operation mode remains the same as the main screen when it is **Measure with 24V**. If **Volts Measure** was selected from the Main menu, the menu defaults to communicator mode only and the 250  $\Omega$  resistor selection shows **n/a**.

The 250  $\Omega$  resistor selection cannot be edited in communicator mode.

The mode and resistor will change from the last selections made in the **HART Comm. Menu** when you exit the menu.

The mode and 250  $\Omega$  resistor settings must correspond to how the test leads are connected before you connect. See Figure 23.

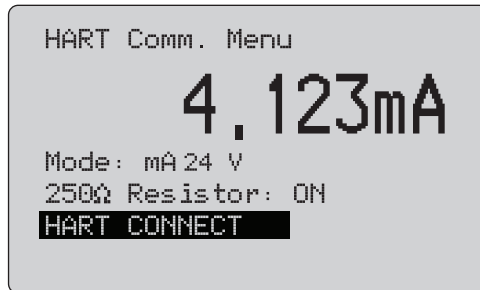



Figure 23. HART Comm. Menu Screen

Select a function from the menu and push the selection knob to do the function. Push  to disconnect from HART mode and go to the function home screen without action.

An error shows and no action is taken if the measured input is out of range, **OL** or **-OL**.

**250 $\Omega$  Resistor** and **HART CONNECT** functions are described in subsequent sections.

### Mode

The **Mode** function from the **HART. Comm. Menu** lets you select what mode to work in. See Figure 24.

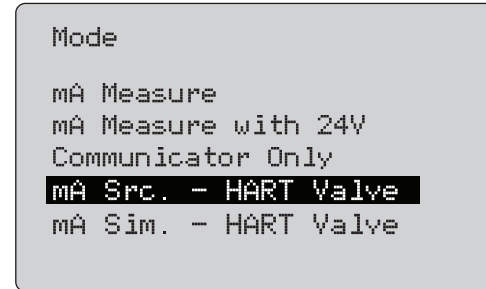

Figure 24. Mode Selection Screen

Use the selection knob to choose the mode:

- **mA Measure**- The Product is in circuit and loop power is supplied externally.
- **mA Measure with 24V**- The Product is in circuit and the loop power is supplied by the Product.
- **Communicator Only**- The Product is across the circuit and the loop power is supplied externally. The 250  $\Omega$  resistor selection defaults to n/a (not applicable).
- **mA Src HART Valve**- to source mA signals and communicate HART to connect and communicate with control valves.
- **mA Sim HART Valve**- to simulate mA signals and communicate HART to connect and communicate with control valves with control system 24 V loop power.

### 250Ω Resistor

The **250Ω Resistor** function lets you turn the 250 Ω resistor on or off. Use the selection knob to change the resistor to the highlighted selection and return to the **Setup and Selection** screen. See Figure 25.



Figure 25. 250Ω Resistor Screen

### HART Connect

The **HART Connect** function locates the HART device in the loop. Before an operation with a HART device, the device must be located on the loop. This is done by polling all of the possible device addresses and selecting a device from those addresses that respond to the search.

If a HART protocol revision 5 or earlier device is found on the loop, polling stops at poll address 15. If not found, the Product continues to poll address 63. Polling stops after 10 devices are found on the loop.

If multiple devices are found on the loop, a tag list shows. From the list, select the correct device. If only one device is found on the loop, it becomes the selected device by default.

When a selected device is found, all relevant data is read from the device and the operations described in the *Function Select Menu* and *Device Setup and Data* sections of this manual become available.

### Polling Loop

The **Polling Loop** function searches the loop for HART devices. This function starts immediately. The screen changes to show the string of dots that is extended once per second to as the operation progresses. See Figure 26.

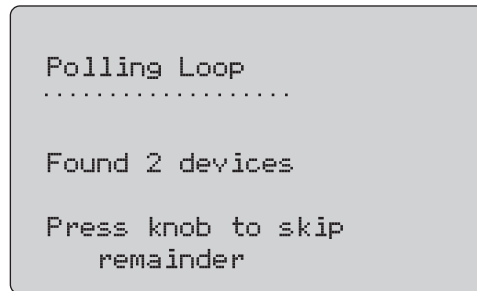



Figure 26. Polling Screen

The number of devices found on the loop during polling shows.

The selection knob can be pushed to stop polling early if it is known that all of the devices on the loop have been found. Push  to stop polling, disconnect from HART mode, and go to the function home screen.

An error shows if no device is found.

If multiple devices are found, a list of tags shows. Use the list of tags to select the device.

If only one device is found, the tag selection step is skipped.

### Tag Selection

The tag selection screen lists all of the long tag names found during polling. Tag names can span two lines if to show all of the text.

If the long tag name is not available, or it is blank, a short tag name is used. If the short tag name is blank, the text **Poll address x** is used.

Use the selection knob to go to the tag. See Figure 27.

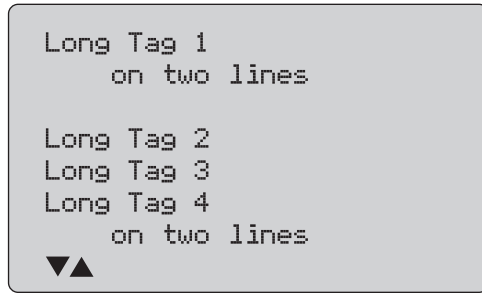

Figure 27. Tag Selection Screen

### Acquiring Data

The **Acquiring Data** screen shows while the Product acquires all of the configuration data from the device. The string of dots extends once per second to show the operation progress. ♥ flashes in the upper-right corner to show a live HART connection.

The screen in Figure 28 shows the name of the tag that is accessed.

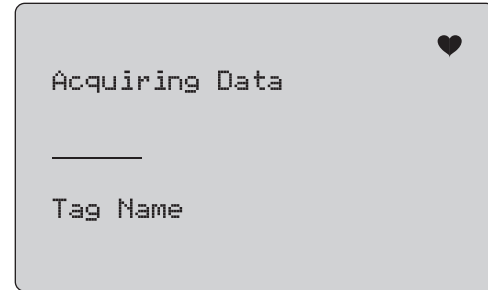



Figure 28. Acquiring Data Screen

Push  to stop data acquisition, disconnect from HART mode, and go to the function home screen.

When data acquisition is complete, the **Function Select Menu** shows.

### Disconnect from Loop

The **Disconnect from Loop** screen shows before the Product returns to the function home screen so the Product can be disconnected from the Loop. See Figure 29.

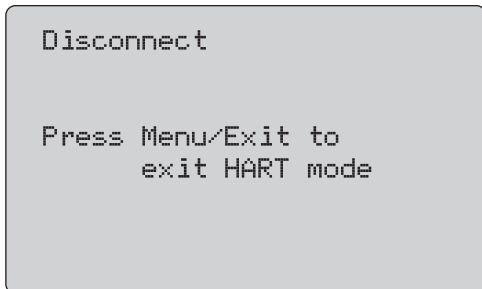

Figure 29. Disconnect from Loop Screen

### Function Select Menu

The **Function Select** menu shows in Figure 30.

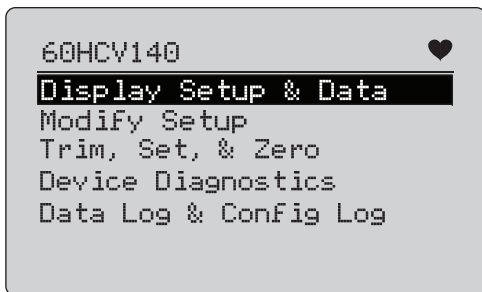



Figure 30. Function Select Menu

The tag name is truncated if too long to fit on one. ♥ flashes in the upper-right corner to show a live connection.

Use the selection knob to choose the action. Push  to disconnect from HART mode and go to the function main screen.

### Display Setup and Data

The **Display Setup and Data** screen spans 11 screens with the format shown in Figure 31.

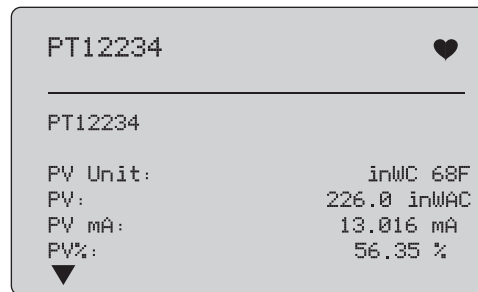



Figure 31. Sample Screen

This screen shows all of the data retrieved from the data acquisition procedure.

The tag name is truncated if too long to fit on one line. ♥ flashes in the upper-right corner to show a live connection.

Each screen holds a maximum of 6 data points. An item can span more than one line to show the full text. If a data item is not supported in the HART device, it is marked n/a (not available). Data items that change dynamically in the HART device are updated as often as possible on the screens.

Turn the selection knob to go from screen to screen. Push  to go to the **Function Select** menu.

## Write LRV and URV Values

### Note

For the screens in this section, tag names can be truncated to fit on one line. ♥ flashes in the upper-right corner to show a live connection.

If the HART write commands are not active, these functions are not available and an error message shows instead of the screen in Figure 32.

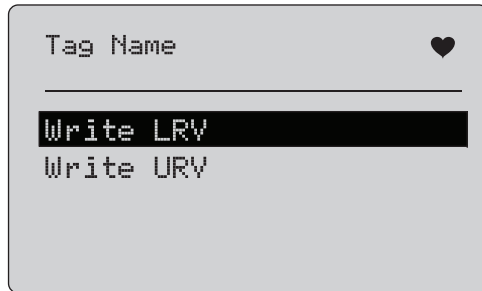



Figure 32. Write LRV and URV Screen

Use the selection knob to choose the function. Push the selection knob to choose the highlighted action and go to the corresponding screen. See *Write LRV* and *Write URV*. Push  to go to the **Function Select** menu.

## Write LRV

The Product warns you to change the loop to MANUAL before you proceed. Push the selection knob to proceed. Push  to go to the **Write LRV** and **Write URV** menu.

The present LRV value and units show. See Figure 33.

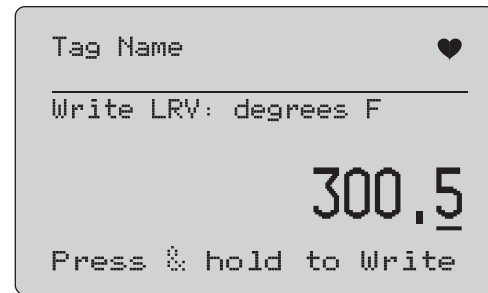



Figure 33. Write LRV Screen

1. Push the selection knob to move the decade cursor.
2. Turn the selection knob to increment or decrement the value in steps indicated by the selected decade.
3. Push and hold the knob to send the new value to the HART device. An error shows if the HART device rejects the value.
4. Push  to go to the **Function Select** menu. A reminder to change the loop to **AUTOMATIC** shows first.

### Write URV

The Product warns you to change the loop to **MANUAL** before you proceed. Push the selection knob to proceed. Push  to go to the **LRV and URV** menu.

The present URV value and units show. See Figure 34.

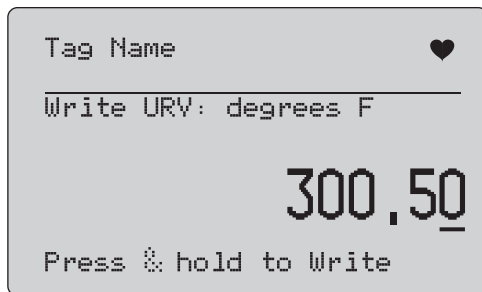



Figure 34. Write URV Screen

1. Push the selection knob to move the decade cursor.
2. Turn the selection knob to increment or decrement the value in steps indicated by the selected decade.
3. Push and hold the knob to send the new value to the HART device, remaining on this display. An error shows if the HART device rejects the value.
4. Push  to go to the LRV and URV menu. A prompt to change the loop to **AUTOMATIC** shows first.

### Write PV Unit

The Product warns you to change the loop to **MANUAL** before you proceed. Push the selection knob to proceed. Push  to go to the **Modify Setup** menu.

The available units show with the present unit. For example, if the present unit is PSI, a list of pressure units show. Another example is if the present unit is °C, a list of temperature units show.

PV Units settings are limited to the common practice command specification for HART protocol. Support for non-standard PV units is limited if proprietary to a manufacturer that uses device-specific commands. See Figure 35.

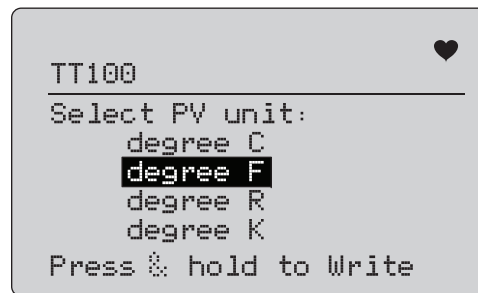



Figure 35. Write PV Unit Screen

The tag name is truncated if too long to fit on one line. The  symbol in the upper right corner flashes to show a working HART connection.

To write a new value:

1. Rotate the selection knob to move the highlight
2. Push and hold the selection knob to send the new value to the HART device.

The screen prompts you to change the loop to **AUTOMATIC** and changes to the **Modify Setup** menu.

An error message shows if the HART device rejects the value for any reason.



- Push  to return to the **Modify Setup** menu. The screen prompts you to change the loop to AUTOMATIC.

### Modify Tags, Msg, Descr

Select the item to modify from the menu. See Figure 36.

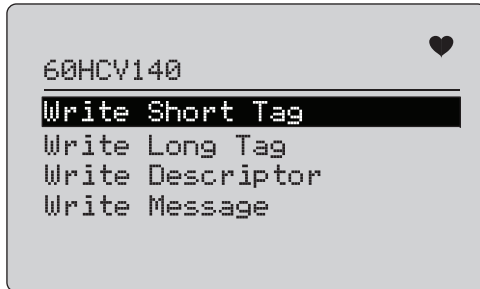

**Figure 36. Modify Tags, Msg, Descr**

The tag name is truncated if too long to fit on one line. The ♥ symbol in the upper right corner flashes to indicate a working HART connection.

Rotate the selection knob to move the highlight. Push the selection knob to move to the edit screen. See Figure 37 for an example of a short tag.

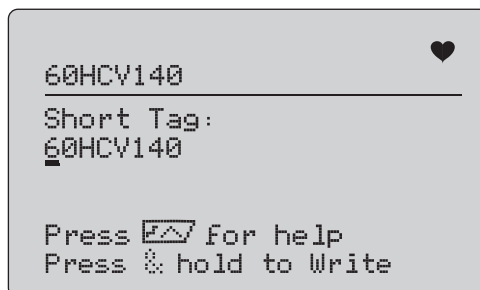

**Figure 37. Short Tag**

The tag name is truncated if too long to fit on one line. The ♥ symbol in the upper right corner flashes to indicate a working HART connection.

The character selected for change is indicated by an underline cursor:







- Short tag is up to 8 characters long from a limited character set that does not include lower case.
- Long tag is up to 32 characters long from the full character set.
- Descriptor is up to 16 characters long from a limited character set that does not include lower case.
- Message is up to 32 characters long from a limited character set that does not include lower case.

To modify a character:

1. Rotate the selection knob to scroll through the available character set.
2. Push and hold the selection knob to send the new value to the HART device and return to the **Modify Setup** menu.

An error shows if the HART device rejects the value for any reason.

Tips:

- Push the selection knob to move the cursor one character to the right.
- Push  to move the cursor one character to the left.
- Push  to delete the selected character.
- Push  to insert a space in front of the selected character.
- Push  to show a help screen.
- Push the selection knob or  on the help screen to resume the modification at the same position.
- Push  to return to the **Modify Setup** menu.

## Trim, Set, and Zero Menu

### Note

For the screens in this section, tag names can be truncated to fit on one line. ♥ flashes in the upper-right corner to show a live connection.

If the HART write commands are not enabled, these functions are not available and an error message shows instead of the screen shown in Figure 38.

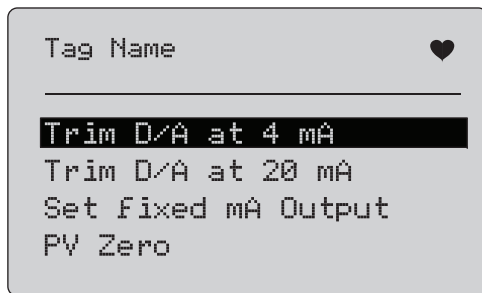



Figure 38. Trim, Set, and Zero Screen

Use the selection knob to select and start the action. Push  to go to the Function Select menu.

## Trim 4 mA

If the operation mode is Communicator Only, this function is not available and an error message shows.

A prompt to change the loop to MANUAL before you proceed shows. Push the selection knob to proceed. Push  to go to the **Trim, Set and Zero** menu.

While the HART device is changed to fixed output mode, an error shows if the HART device rejects the mode change command. When the mode change is successful, the screen in Figure 39 shows.

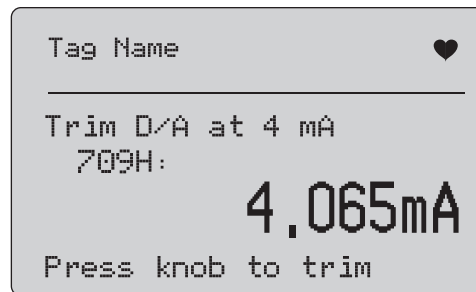



Figure 39. Trim 4 mA Screen

While the output to settles at 4 mA, the screen shows the Product measurement. The measurement updates once a second.

1. Push the selection knob to trim the HART device. Stay on this screen to evaluate the result. An error shows if the HART device rejects the trim command.
2. Push  to change the HART device to normal output mode and go to the Trim, Set, and Zero menu. A warning to change the loop to AUTOMATIC shows first. An error shows if the device rejects the mode change command.

### Trim 20 mA

If the operation mode is Communicator Only, this function is not available and an error message shows.

A warning to change the loop to **MANUAL** before you proceed shows. Push the selection knob to proceed. Push  to go to the **Trim, Set and Zero** menu.

While the HART device is changed to fixed output mode, an error shows if the HART device rejects the mode change command. When the mode change is successful, the screen in Figure 40 shows.

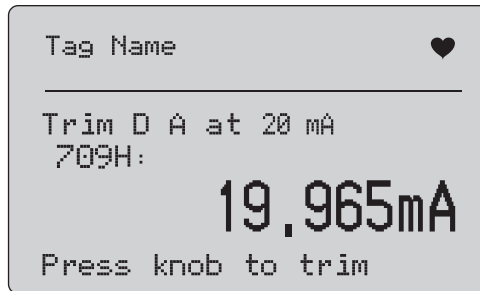



Figure 40. Trim 20 mA Screen

As the output to settles at 20 mA, the screen shows the Product measurement. The measurement is updated once a second.

1. Push the selection knob to trim the HART device. Stay on this screen to evaluate the result. An error shows if the HART device rejects the trim command.
2. Push  to change the HART device to normal output mode and go to the Trim, Set, and Zero menu. A prompt to change the loop to **AUTOMATIC** shows first. An error shows if the device rejects the mode change command.

### Set Fixed mA Output

If the operation mode is Communicator Only, this function is not available and an error message shows.

A warning to change the loop to **MANUAL** before you proceed shows. Push the selection knob to proceed. Push  to go to the **Trim, Set and Zero** menu.

As the HART device is changed to fixed output mode, an information screen shows. An error shows if the HART device rejects the mode change command. When the mode change is successful, the screen in Figure 41 shows.

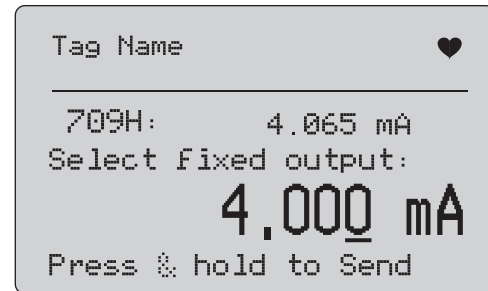



Figure 41. Set Fixed mA Output Screen

This screen is used to set a fixed output and monitor the result with the Product measurement. The measurement is updated once a second.

The range of values that can be set is 3.0 mA to 21.0 mA.

1. Use the selection knob to select and increment or decrement the value in steps shown by the selected decade.
2. Push and hold the selection knob to send the new value to the HART device and stay on this screen. An error shows if the HART device rejects the value.
3. Push  to change the HART device to normal output mode and go to the Trim, Set, and Zero menu. A warning to change the loop to **AUTOMATIC** shows first. An error shows if the device rejects the mode change command.

## PV Zero

A warning to change the loop to **MANUAL** before you proceed shows. Push the selection knob to proceed. Push  to go to the **Trim, Set, and Zero** menus.

The screen in Figure 42 prompts you to set the PV process input signal to zero and then monitors the result with the Product measurement. The measurement updates once a second.

When the operation mode is **Communicator Only**, the mA measurement is not available and the message, **mA not available**, in Comm. Only mode shows instead.

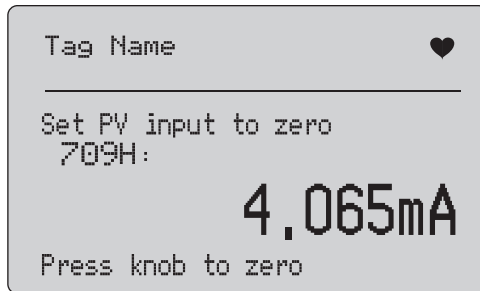



Figure 42. PV Zero Screen

1. Push the selection knob to zero the HART device, and stay on this screen to evaluate the result. An error shows if the HART device rejects the zero command.
2. Push  to go to the **Trim, Set, and Zero** menu. A prompt to restore the PV process input signal to normal operation configuration and change the loop to AUTOMATIC shows first.

## Device Diagnostic

### Note

*For the screens in this section, tag names can be truncated to fit on one line. ♥ flashes in the upper-right corner to show a live connection.*

If the HART write commands are not active, this function is not available and an error message shows.

A warning to change the loop to **MANUAL** before you proceed shows. Push the selection knob to proceed. Push  to go to the Function Select menu.

Push the selection knob to select and start the self test. See Figure 43.

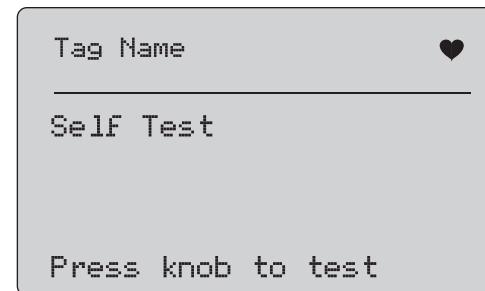

Figure 43. Self Test Screen

When the self test is in progress, the bottom line of the screen changes to **Testing** and a string of dots extends 1/second to show the operation progress.

At the end of the self test, the screen in Figure 44 shows. The screen shows No errors or the first error is reported.

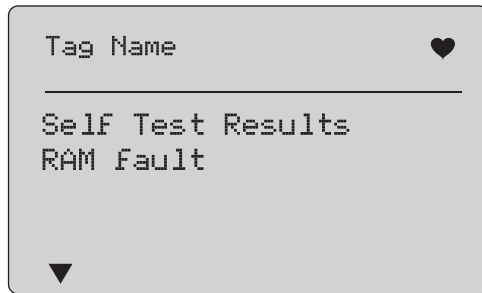



Figure 44. Self Test Results Screen

The lower-left corner shows ▼ when additional errors follow the present error. ▲ shows when additional errors precede the present error. ▼ and ▲ show when additional errors follow and precede the present error.

1. Turn the selection knob to step between errors.
2. Push  to go to the Function Select menu. A reminder to change the loop to **AUTOMATIC** shows first.

## Configuration Log and Data Log

Configuration Log and Data Log are available when connected to a HART device. Use the selection knob to choose either the **Configuration Log** or **Data Log**. See Figure 45.

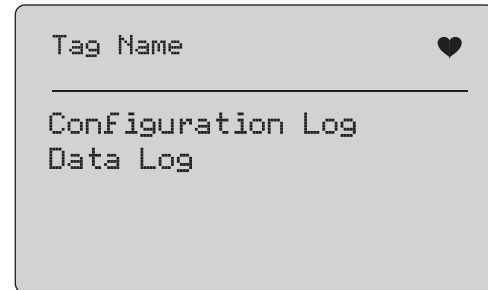

Figure 45. Data Log and Configuration Log Screen

### Configuration Log

Configuration data for a maximum of 20 tags can be stored for later recall. The configuration data saved is the same as that shown on the Device Data screen.

The initial Configuration Log screen spans more than one screen and shows a list of the tags held in storage. If a storage position is not used, the tag name area shows **<empty>**. See Figure 46.

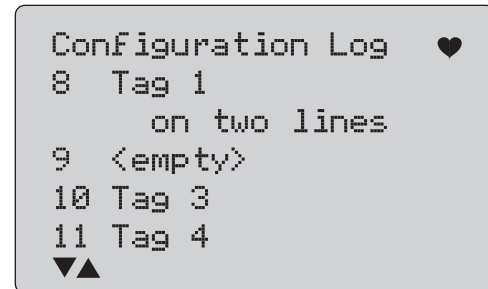



Figure 46. Configuration Log Screen

After a storage position is selected, data can be saved or recalled from it. It can be erased or sent to the USB port.

*Note*

*With the 710, you can upload data to a PC with the ValveTrack Windows Software and included USB communications cable.*

To select:

1. Use the selection knob to highlight and select the correct storage location.
2. Push  to go to the **Log Select** menu.

When a storage position is selected, the menu in Figure 47 shows.

3. Select the action.

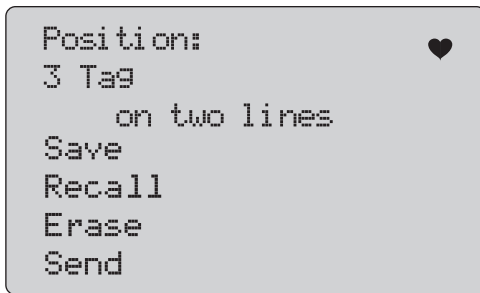

**Figure 47. Configuration Log Showing Storage Position**

The number and contents of the storage position show at the top. The tag number is <empty> if the storage position is empty.

Use the selection knob to highlight and select the correct function.

Push  to go to the **Log Select** menu.

**SAVE** operation:

- If the position is empty, save the present device configuration data into the storage position.
- If the position is in use, confirm that the existing data is to be replaced with the present tag data before you save it into the storage position.

**RECALL** operation:

- If the position is empty, an error message shows.
- If the position is in use, the data shows in a sequence of screens identical to the Device Data screen.

**ERASE** operation:

- If the position is empty, an error message shows.
- If the position is in use, confirm that the existing data is to be permanently deleted before doing so.

**SEND** operation:

- If the position is empty, an error message shows.
- If the position is in use, send the data to the RS232 port in a report format.

### **Data Log**

Process data can be stored for a single tag for later upload to a PC with the ValveTrack Windows Software. See *Configuration Log*.

Data can be logged in multiple sessions, but all sessions must be from the same HART device as determined by the long tag name. A different logging interval can be selected for each session. Each data sample has the Product measurement, device mA, and all four process variables.

There are 9810 records available. See Figure 48. Each data sample uses one record. Each session uses two records for overhead data that is common to all of the data samples in that session. There can be from 1 to 99 sessions.

The total number of data samples that can be logged:

- 709H - 9810 (less 2 x the number of sessions started and stopped)
- 710 - 4910

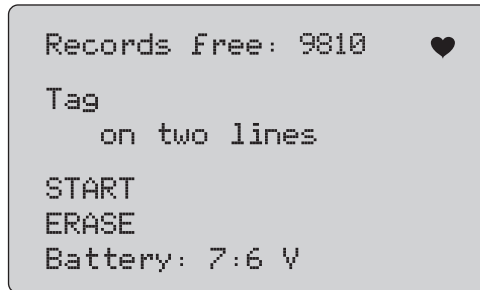



Figure 48. Data Log Screen

The number of free records show on the first line. If data has already been logged, the tag number shows below it.

The present battery voltage shows at the bottom to indicate if the batteries should be changed before a log session starts. The log is stopped before the Product is turned off when the battery reaches its low voltage automatic shutoff limit of 5.6 V.

1. Use the selection knob to highlight and select the function.
2. Push the knob to do the operation.
3. Push  to return to the Log Select menu.

**START** operation:

- If no free records or free sessions remain, or the present HART device does not match the HART device already logged, an error message shows.
- Otherwise, proceed to interval selection described below.

**ERASE** operation:

- If there is no logged data, an error message shows.
  - Otherwise, confirm that the present data is to be permanently erased before doing so.
4. Select the logging interval. See Figure 49.

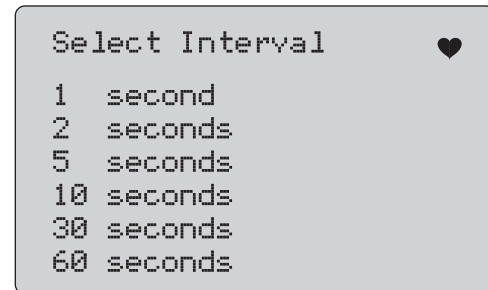



Figure 49. Logging Interval Screen

5. Turn the selection knob to move the highlight and select the interval.
6. Push the selection knob to start logging at that interval.
7. Push  to go to the first data log screen.

While logging, the screen in Figure 50 shows to monitor progress.

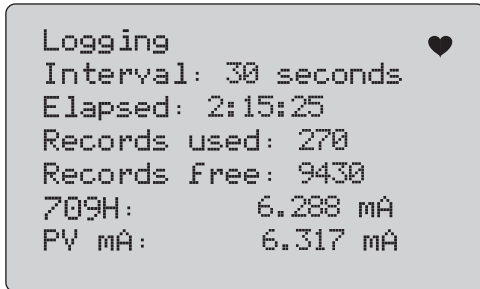



Figure 50. Active Logging Screen

8. Push  to stop logging and go to the first data log screen.

The data items are:

- The top line indicates is logging is in progress (Logging) or is stopped (Stopped). Logging stops automatically when storage is full or before the Product is turned off when the battery reaches its low voltage automatic shutoff limit of 5.6 V.
- Interval is the item previously selected.
- Elapsed is the time since the log was started, updated each time a new sample is saved.
- Records used is the total number used to date for all sessions, updated each time a new sample is saved.
- Records free is the total number that remain unused, updated each time a new sample is saved.
- 709H is the present measurement, updated as often as possible.
- PV mA is the last HART device measurement, updated as often as possible.

## Valve Tests (710)

The 710 adds specialty tests to the basic HART functionality of the 709H to perform tests on HART smart valve positioners.

1. Connect to the control valve.
2. Push .
3. Turn the selection knob to move the highlight to **HART Comm** menu and push the selection knob to select.
4. Push the selection knob to select the option.
5. Rotate the selection knob to highlight **mA Src. - HART Valve** and push the knob to make the selection.
6. Select **HART CONNECT** to initiate HART polling for connected HART devices.
7. When the 710 finds a device, push the selection knob to select.
8. From the HART Valve operation screen, select **Valve Tests**.

See available options for valve tests in Figure 51.

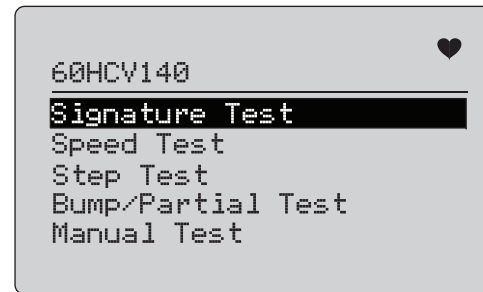

Figure 51. Valve Tests



## Signature Test

In the Signature Test, the product sources a ramping 4 mA to 20 mA to 4 mA signal and records the pressure applied to the actuator from the positioner and the position.

To set up:

1. Go to **Signature Test Menu**. See Figure 52.

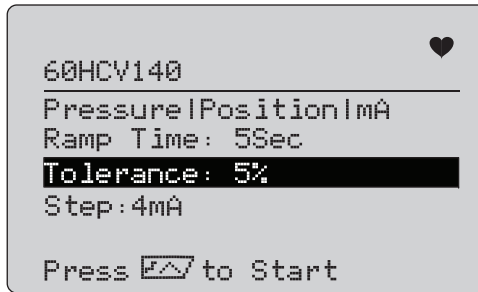

Figure 52. Signature Test Setup

2. Push the knob to move the cursor through the options.
3. Confirm the **Ramp Time**, change if needed.
4. Change the **Tolerance** as required from 1 % to 20 %.
5. In the Calibrator Setup Menu, select **Test Tolerance > Valve Test Parameters** to set the default test tolerances.
6. Change the size of steps as required from 0.1 mA to 4.0 mA.

To run the test:

1. Push **[F8]** to start the test.

The Product varies the 4 to 20 mA signal, monitors the **TV** and **QV** variables (pressure and position), and compares it to expected values.

- Good test result: the position variable is as expected.
- Marginal test result: the position variable value is found to be close to the test tolerance.
- Bad test result: the position variable deviation values vary greater than the tolerance.

2. Select **Save** to save the test results and upload later to the ValveTrack software.

Or, select **Discard** if you do not want to save the test result.

## Manual Test

Select **Manual Test** to see the mA signal applied and HART variables. See Figure 53.

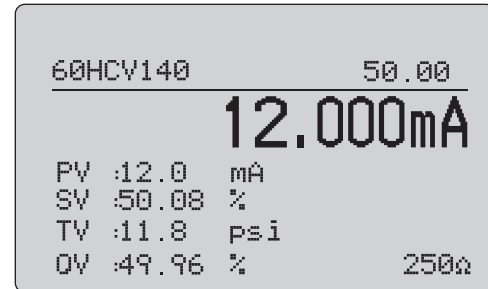

Figure 53. Manual Test

The HART variables that show on the display are important information about the operation of the valve.

HART variable mapping:

**PV:** Digitized mA value that represents the mA value applied to the valve.

*Note*

*This value should agree closely with the applied mA value.*

**SV:** Setpoint where the valve is expected to be at in % of travel. Valves forward acting are configured to Fail Open (FO) as the 4 to 20 mA signal moves the valve from 0 % to 100 % of travel (from open to closed) with 4 to 20 mA signals applied. If the valve is configured as FC and is forward acting, the valve opens as the applied mA signal increases to 20 mA.

If the positioner is configured to be reverse acting, the relationship of mA signal to control valve opening and closing is reversed. Configuration for forward or reverse action does not change the mode in which the valve fails.

**TV:** This variable is the pressure applied to the pneumatic actuator by the valve positioner. With 4 mA applied in a Direct Acting positioner, the minimum or 0 psi of pressure is applied and the valve spring holds the valve into the failure mode position (FO or FC). With 20 mA applied, the direct acting actuator has maximum pressure applied to the actuator from the positioner moving it to the 100 % position and the opposite of the failure position. Reverse acting actuators respond opposite of direct acting actuators with 4 to 20 mA signals applied.

**QV:** This is the position feedback variable (0 % to 100 %). The position feedback variable should agree closely with the Setpoint variable (SV). If it does not, the positioner should be calibrated to better match the position of the valve or repair is required.

To run the manual test:

1. Push the ,  and  to change the valve position and the mA output.
2. Manually compare the variable to what is expected.

*Note*

*When the Valve Test is set to ON (Figure 13),  changes the mA signals to step with stops at 3.8 mA, 4.2 mA, 19.8 mA, and 20.2 mA to make manual valve testing easier (see Valve Test).*

## Speed Test

The Speed Test is a test of the time it takes to open and close the valve.

To set up the expected time to cycle the valve in seconds from 10 seconds and up:

1. Move the cursor to the digit to change.
2. Rotate the selection knob to change the time value.
3. Push the selection knob to input the change.

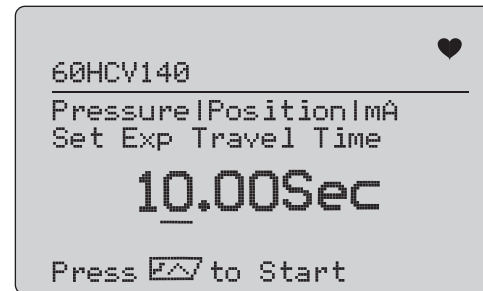

**Figure 54. Speed Test**

To run the test:

1. Push  to start the test.
  - Good test result: the position variable is as expected.
  - Marginal test result: the position variable value is found to be close to the test tolerance.
  - Bad test result: the position variable deviation values vary greater than the tolerance.
2. Select **Save** to save the test results and upload later to the ValveTrack software.  
Or, select **Discard** if you do not want to save the test result.

## Step Test

In this test the mA signal is changed in steps and compared to the position variable (QV).

To set up the step size for the test from 0.1 mA to 4 mA, rotate the selection knob to change the mA value.

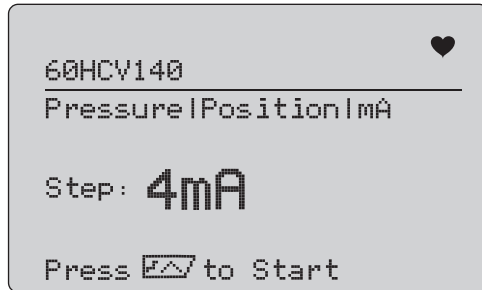

Figure 55. Step Test

To run the test:

1. Push **[F/A]** to start the test.
  - Good test result: the position variable is as expected.
  - Marginal test result: the position variable value is found to be close to the test tolerance.
  - Bad test result: the position variable deviation values vary greater than the tolerance.
2. Select **Save** to save the test results and upload later to the ValveTrack software.  
Or, select **Discard** if you do not want to save the test result.

## Bump/Partial Test

The Bump/Partial Test is a test of the valve over a smaller portion of the stroke, or bump the mA value, to find if the valve moves as expected. This is also done with a Manual Test of the position or other values.

To set up:

1. Set the start and stop stroke values in % of travel.

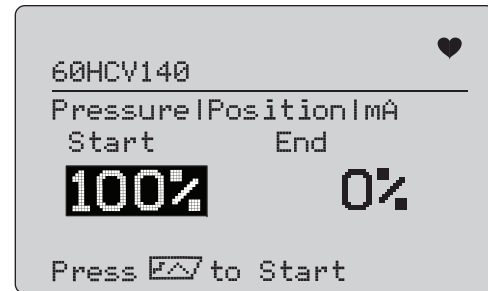

Figure 56. Bump/Partial Test

To run the test:

1. Push **[F/A]** to start the test.
  - Good test result: the position variable is as expected.
  - Marginal test result: the position variable value is found to be close to the test tolerance.
  - Bad test result: the position variable deviation values vary greater than the tolerance.
2. Select **Save** to save the test results and upload later to the ValveTrack software.  
Or, select **Discard** if you do not want to save the test result.

## Test Configuration Screens

Use the configuration screens to set the default tolerance of the tests:

1. In the calibrator Setup Menu (see Figure 9), select **Valve Test Parameters** to review the variable mapping. See Figure 57.

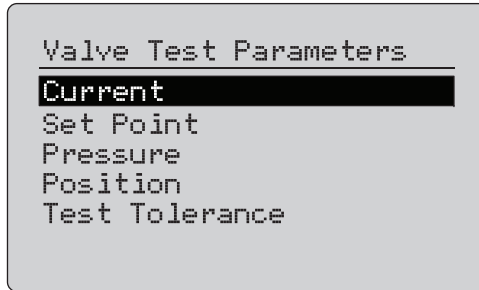

Figure 57. Valve Tests

To set the Test Tolerance:

1. Go to **Valve Test Parameters > Test Tolerances**.
2. Change the individual test tolerances from 1 % to 20 %.

## HART Comms Menu

Use the HART Comms Menu to start autotrim and view device variables and status:

1. Connect to the HART valve.
2. Go to **Modify Setup > HART Comms**. See Figure 58 for the available options.

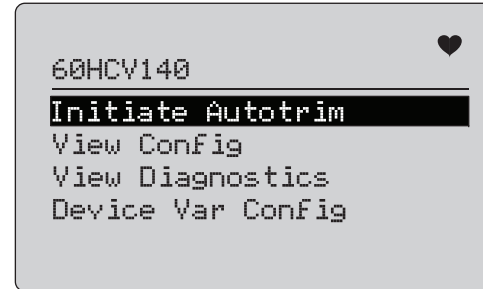



Figure 58. HART Comms. Menu

- **Initiate Autotrim:** Use to autotrim the positioner. At the end of the autotrim, the valve position is set to 50 % and you can quickly decide if additional trimming is required.
- **View Config:** Supports only HART 7 devices. Use to show the device variable classification of PV, SV, TV and QV. Examples include:
  - Pressure
  - Volume Flow
  - Mass Flow

If HART 7 is not supported by the device, the display shows a warning message.

- **View Diagnostics:** Supports only HART 7 devices. Use to show the status of the PV, SV, TV, and QV variables (for example, BAD, MARGINAL, or GOOD). If HART 7 is not supported by the device, the display shows a warning message.
- **Device Var Config:** Use to view the PV, SV, TV and QV variables of the device.

## Valve Test Quick Start Guide

1. Power up the 710.
  - a. Disconnect the mA input wires to valve if connected to a circuit.
  - b. Connect the output leads from the 710 in place of the signal wires (likely to be a bench check and not connected to the control system).
  - c. To move the valve, connect the valve to regulated air supply (house air or other compressed air supply).
2. Push  and select **HART Comm Menu**.
3. Select **HART Comm Menu > HART Connect**.
4. Rotate the selection knob to **Mode** and push the selection knob to input the change.
5. Select **mA Src. – HART Valve > Connect**.
  - a. Wait for the 710 to find the valve through HART communication.
  - b. Once the 710 display shows **Found 1 device**, push the selection knob to input the change.
6. Select **Valve Tests > Signature Test**.

7. Push  to start the test. See Figure 59.
  - Good test result: the position variable is as expected.
  - Marginal test result: the position variable value is found to be close to the test tolerance.
  - Bad test result: the position variable deviation values vary greater than the tolerance.

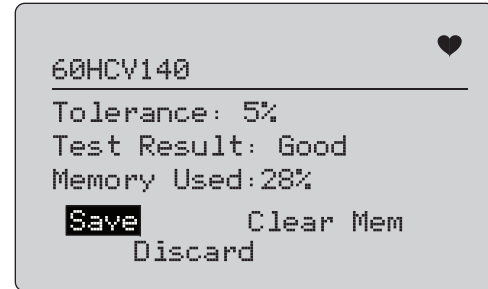





Figure 59. Test Results

To continue, use **Manual Test** to see the real-time HART variables for position and pressure (rotate the knob) as you change the mA output signal (push ,  and  to change the mA value).

## Maintenance

### ⚠⚠ Warning

For safe operation and maintenance of the Product:

- Repair the Product before use if the battery leaks.
- Be sure that the battery polarity is correct to prevent battery leakage.
- Remove the input signals before you clean the Product.
- Use only specified replacement parts.
- Have an approved technician repair the Product.

### Clean the Product

Clean the Product and pressure modules with a soft cloth dampened with water or water and mild soap.

### ⚠ Caution

To prevent possible damage to the Product:

- Do not use solvents or abrasive cleansers.
- Do not allow water into the case.

### Fuse

The Product is protected from overcurrent condition by an internal self-resetting fuse. The fuse will automatically reset within a few seconds. The fuse cannot be repaired manually.

### Battery Replacement

Replace the batteries when the battery indicator shows on the display.

To replace the batteries:

1. Turn the Product over so the display is face down.
2. Lift bail to access the battery door. See Figure 60.
3. With a flat-head screwdriver, remove the battery door screws.

4. Remove the batteries.
5. Replace the old batteries. Note the correct polarity as the new batteries are installed.
6. Attach the battery door.
7. Replace and tighten the two battery door screws.

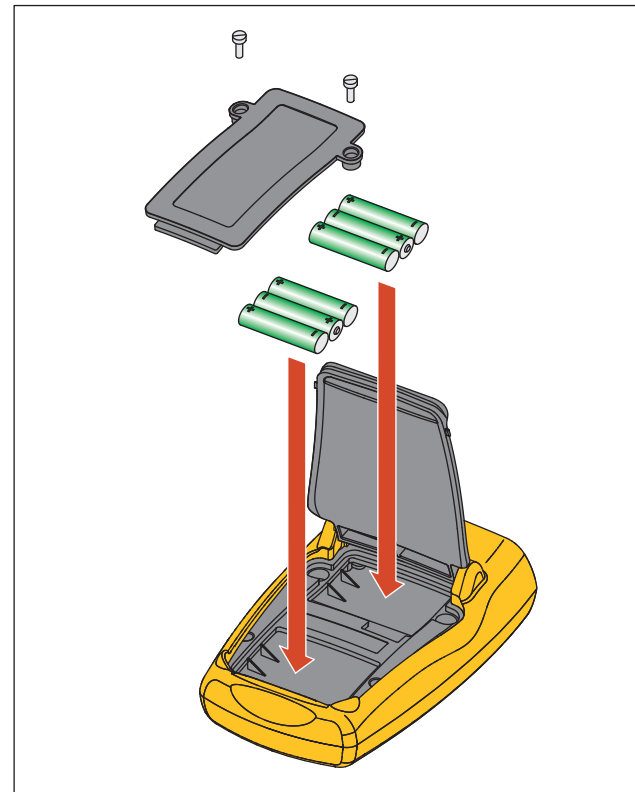

Figure 60. Battery Replacement

## User-Replaceable Parts

Table 5 is a list of user-replaceable parts. For more information about these items and their prices, contact a Fluke representative. See *How to Contact Fluke*.

**Table 5. User-Replaceable Parts**

Item	Fluke Part Number
Fluke-709-2005, Knob	4282155
Fluke-709-2001, Case Top	4440380
Fluke-709-2002, Case Bottom	4440371
Fluke-709-2003, Battery Door	4440405
Fluke-709-2004, Connector Panel	4440398
Fluke-709-2006, Holster, Fluke-709	4241437
Fluke-709H-2006, Holster, Fluke-709H	4241443
Fluke-709-2007, Bail, Fluke709/709H	4241455
Fluke-709-8003, Keypad, Fluke-709/709H	4252551
TL75-4201, Test Leads	855742
AC280 Suregrip Hook Clip (black)	2063165
AC280 Suregrip Hook Clip (red)	1613782
TP220 Test Probes (red)	2047206
TP220 Test Probes (black)	2063129
Alligator Clip Set, Extended Tooth	3765923
Stackable Lead Set	3669716
USB to 5-Pin Cable, 6-ft	4401616
710 ValveTrack Software	available as a free download at <a href="http://www.fluke.com">www.fluke.com</a>
709H/TRACK, Datalogging Software & Cable	4281225
Softcase	2643273

## Specifications

### Ranges

mA ..... 0 mA to 24 mA  
Volts ..... 0 V dc to 30 V dc

### Resolution

mA Ranges ..... 1  $\mu$ A  
Voltage Range ..... 1 mV

Accuracy ..... 0.01 %  $\pm$ 2 LSD all ranges (@23 °C  $\pm$ 5 °C)

Stability ..... 20 ppm of F.S. /°C from -10 °C to 18 °C and 28 °C to 55 °C

Operating Temp Range ..... -10 °C to 50 °C (14 °F to 122 °F)

Storage Temp Range ..... -20 °C to 60 °C (-4.0 °F to 140 °F)

Altitude ..... 3000 meters

Ingress Protection Rating ..... IEC 60529: IP40

Humidity Range ..... 10 % to 95 % non-condensing

Display ..... 128 x 64 pixels, LCD Graphic with backlight, 8.6 mm high digits

Power ..... Six IEC LR03 batteries

Battery Life (Alkaline Batteries) .....  $\geq$ 40 hours continuous use (measure mode)

Loop Compliance Voltage ..... 24 V dc @ 20 mA

Loop Drive Capability ..... 1200  $\Omega$  without HART resistor, 950  $\Omega$  with HART resistor

Dimensions (LxWxD) ..... (152 x 93 x 44) mm, (6.0 x 3.7 x 1.7) in

Weight ..... 0.3 kg (9.5 oz)



---

Safety .....	IEC 61010-1: Pollution Degree 2
Electromagnetic Compatibility (EMC)	
International .....	IEC 61326-1: Portable Electromagnetic Environment IEC 61326-2-2 CISPR 11: Group 1, Class A <i>Group 1: Equipment has intentionally generated and/or uses conductively-coupled radio frequency energy that is necessary for the internal function of the equipment itself.</i> <i>Class A: Equipment is suitable for use in all establishments other than domestic and those directly connected to a low-voltage power supply network that supplies buildings used for domestic purposes. There may be potential difficulties in ensuring electromagnetic compatibility in other environments due to conducted and radiated disturbances.</i> <i>Caution: This equipment is not intended for use in residential environments and may not provide adequate protection to radio reception in such environments.</i> <i>Emissions that exceed the levels required by CISPR 11 can occur when the equipment is connected to a test object.</i>
Korea (KCC) .....	Class A Equipment (Industrial Broadcasting & Communication Equipment) <i>Class A: Equipment meets requirements for industrial electromagnetic wave equipment and the seller or user should take notice of it. This equipment is intended for use in business environments and not to be used in homes.</i>
USA (FCC).....	47 CFR 15 subpart B. This product is considered an exempt device per clause 15.103.

