

NH-Reiter-Sicherungs-Lasttrennschalter Gr. 00

NH-bus-mounting fuse-switch disconnecter size 00
 Interrupteur-sectionneur-fusibles DIN taille 00
 Sezionatore per fusibili NH 00
 Seccionador bajo carga sobre barras para fusibles NH 00
 NH-熔断器负荷隔离开关（母线式），尺寸 00

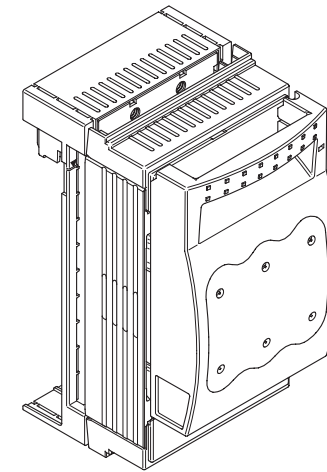

Achtung: Vor Installations- oder Servicearbeiten Stromversorgung unterbrechen, um Unfälle zu vermeiden. Die Geräte müssen in einem passenden Gehäuse eingebaut und gegen Verschmutzung geschützt werden. Inbetriebsetzung und Wartung nur durch Fachpersonal!

Attention: To prevent electrical shock, disconnect from power source before installing or servicing. Install in suitable enclosure. Keep free from contaminants. To be commissioned and maintained only by qualified personnel!

Attention: Avant le montage et la mise en service, couper l'alimentation secteur afin d'éviter tout accident. Prévoir une mise en coffret ou armoire appropriée. Protéger le produit contre les environnements agressifs. Mise en service en entretien: seulement par du personnel spécialisé!

Attenzione: Per prevenire infortuni, togliere tensione prima dell'installazione o manutenzione. Installare in custodia idonea. Tenere lontano da contaminanti. Messa in servizio e manutenzione solo da personale specializzato!

Atención: Con el objeto de evitar accidentes, hay que desconectar la alimentación eléctrica antes de realizar el montaje y la puesta en marcha. Debe instalarse en una caja o armario apropiado. Debe protegerse el producto de los ambientes agresivos. La puesta en marcha y el mantenimiento ha de hacerlo exclusivamente por personal especializado!

注意: 安装前或检修前应切断电源，以防事故。开关应安装在适合的箱体内，同时应做好防污染保护。只有专业人员才能做运行、维护、保养的工作。

