

PIN	DESCRIPTION
1	+24V DC
2	n/a
3	GND
4	IO-Link Kommunikation

ART.-NO. SENSOR X	NAME
07300.0-00	SEN073 (temperature / humidity), IP65
07300.1-00	SEN073 (temperature / humidity), IP20, 1m
07300.1-01	SEN073 (temperature / humidity), IP20, 2m
07301.0-00	SEN073 (pressure / temperature), IP65
07302.0-00	SEN073 (light), IP65

**EVENTS (EXAMPLE FOR ONE TEMPERATURE/HUMIDITY-SENSOR)**

EVENT	SET 1		RESET 0	
	temperature T [°C]	humidity RH [%]	temperature T [°C]	humidity RH [%]
alarm high	T 1.1	H 1.1	T 1.0	H 1.0
range high	T 2.1	H 2.1	T 2.0	H 2.0
range low	T 3.1	H 3.1	T 3.0	H 3.0
alarm low	T 4.1	H 4.1	T 4.0	H 4.0

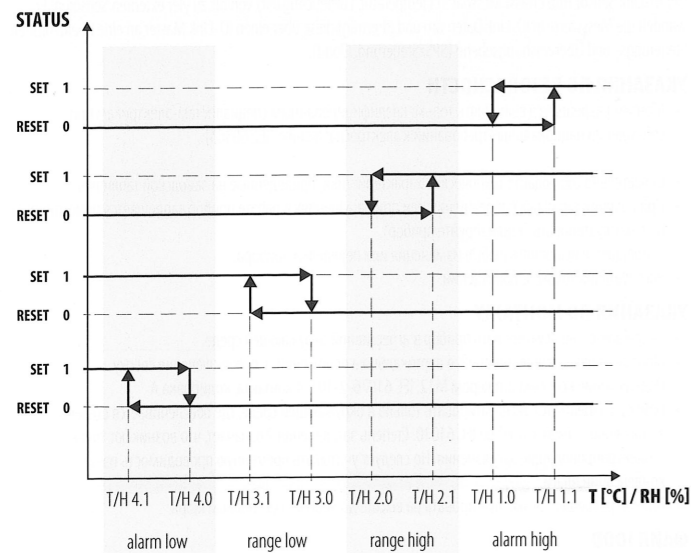

**DIAGNOSIS**

Device status
Error counter
Operating hours
Power-On counter
Event counters for max. a nd min. temperature and humidity values
Event counters for adjustable temperature and humidity parameters
Temperature and humidity histogram-data
Reset counters for temperature and humidity events
Reset whole parameter ( <b>NOTE:</b> Password required „stego“)

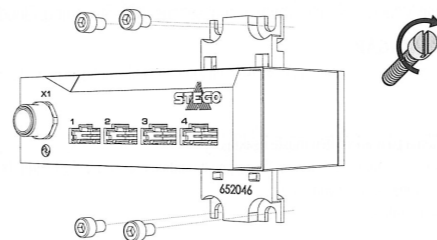
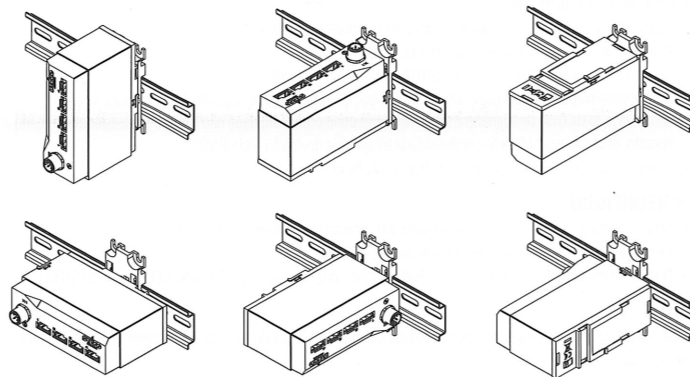
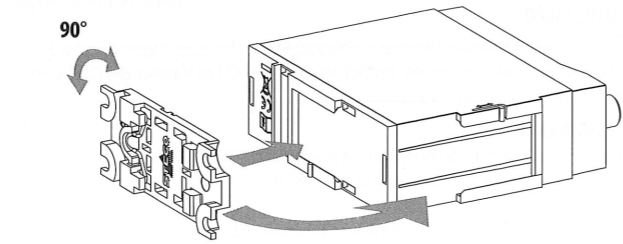

**EXAMPLE**

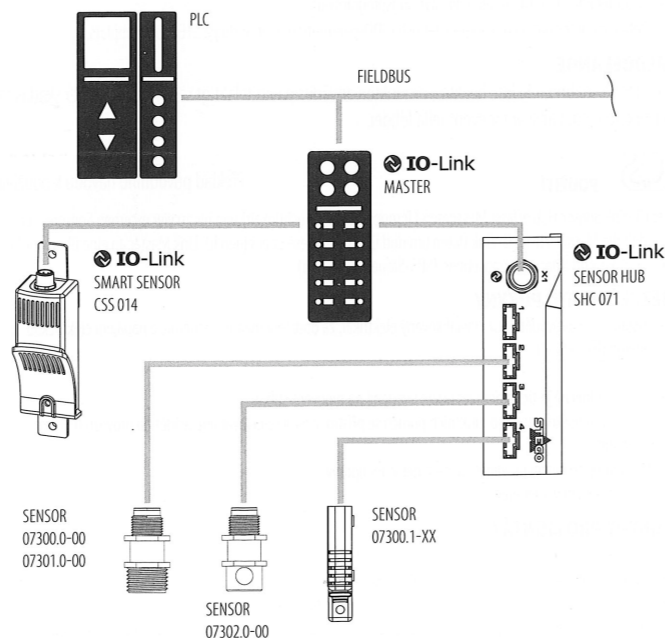

	<b>! WARNUNG</b> Bei Missachtung der Anschlusswerte oder falscher Polung besteht die Gefahr von Personen- und Geräteschädigungen!		<b>! ATENÇÃO</b> No caso de inobservância dos valores de conexão ou no caso de conexão incorreta dos polos, existe o perigo de ferimentos e danos no aparelho!
	<b>! WARNUNG</b> There is a risk of personal injury and equipment damage if the connection values are not observed or polarity is incorrect!		<b>! VARNING</b> Om anslutningsvärden åsidosätts eller vid polningsfel finns risk för person- och materialskador!
	<b>! AVERTISSEMENT</b> Le non-respect des valeurs de raccordement ou une mauvaise polarité peut engendrer des dommages corporels et matériels !		<b>! VAROVÁNÍ</b> V případě nerespektování přípojných hodnot nebo nesprávné polaritě hrozí nebezpečí úrazů a poškození zařízení!
	<b>! ADVERTENCIA</b> En caso de no respetar los valores de conexión o realizar una polaridad errónea, existe el peligro de lesionar a las personas o dañar los equipos.		<b>! OSTRZEŻENIE</b> W przypadku nieprzestrzegania wymaganych parametrów przyłącza albo niewłaściwej biegunowości powstaje zagrożenie urazami ludzi i uszkodzeniem urządzenia!
	<b>! AVVERTENZA</b> Il mancato rispetto dei valori di collegamento o una polarità falsa può causare danni a persone e cose!		<b>! ОСТОРОЖНО</b> при несоблюдении подключаемых значений или неверной полярности существует опасность травм персонала и повреждений оборудования!

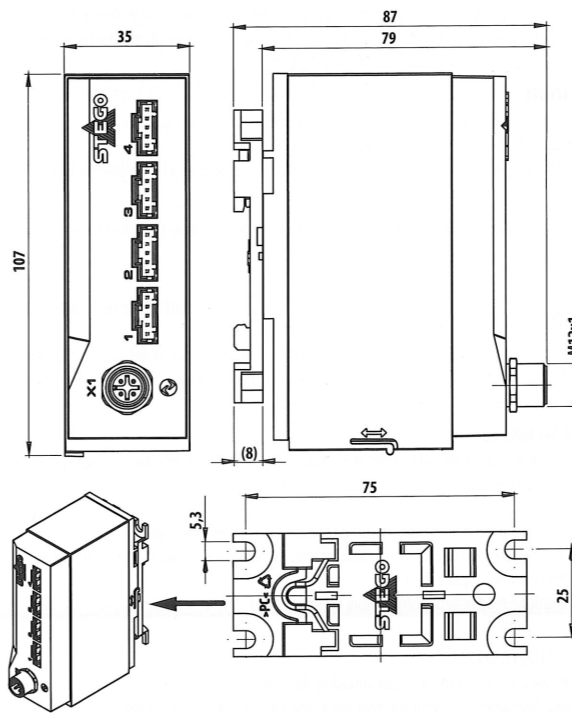

	-40 ... +80°C (-40 ... +176°F) 0 ... 100% RH		DC 24V (18 ... 30V), P max. 0.5 W
	-40 ... +80°C (-40 ... +176°F)		2 Nm max. (17.7 lb-in)
	max. 90% RH		110 g

STEGO Elektrotechnik GmbH - Koipfingstrasse 21 - 74523 Schwaebisch Hall Germany - www.stego.de

**IO-Link**

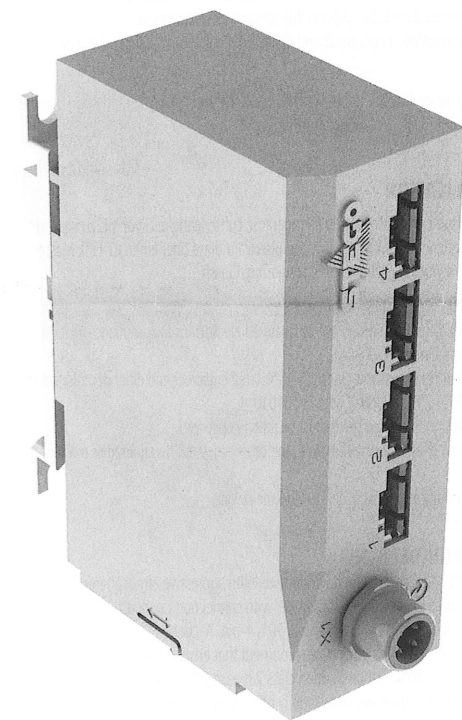

**Type SHC 071**

Zum späteren Gebrauch aufbewahren.  
Store for use at a later date.

IP40



**CE**

DIN EN 60715

07/2020

68128