



Handheld Thermography Camera  
HIKMICRO SP Series

User Manual

## Legal Information

©2022 Hangzhou Microimage Software Co., Ltd. All rights reserved.

### About this Manual

The Manual includes instructions for using and managing the Product. Pictures, charts, images and all other information hereinafter are for description and explanation only. The information contained in the Manual is subject to change, without notice, due to firmware updates or other reasons. Please find the latest version of this Manual at the HIKMICRO website (<http://www.hikmicrotech.com>).

Please use this Manual with the guidance and assistance of professionals trained in supporting the Product.

### Trademarks



**HIKMICRO** and other HIKMICRO's trademarks and logos are the properties of HIKMICRO in various jurisdictions.

Other trademarks and logos mentioned are the properties of their respective owners.

### Disclaimer

TO THE MAXIMUM EXTENT PERMITTED BY APPLICABLE LAW, THIS MANUAL AND THE PRODUCT DESCRIBED, WITH ITS HARDWARE, SOFTWARE AND FIRMWARE, ARE PROVIDED "AS IS" AND "WITH ALL FAULTS AND ERRORS". HIKMICRO MAKES NO WARRANTIES, EXPRESS OR IMPLIED, INCLUDING WITHOUT LIMITATION, MERCHANTABILITY, SATISFACTORY QUALITY, OR FITNESS FOR A PARTICULAR PURPOSE. THE USE OF THE PRODUCT BY YOU IS AT YOUR OWN RISK. IN NO EVENT WILL HIKMICRO BE LIABLE TO YOU FOR ANY SPECIAL, CONSEQUENTIAL, INCIDENTAL, OR INDIRECT DAMAGES, INCLUDING, AMONG OTHERS, DAMAGES FOR LOSS OF BUSINESS PROFITS, BUSINESS INTERRUPTION, OR LOSS OF DATA, CORRUPTION OF SYSTEMS, OR LOSS OF DOCUMENTATION, WHETHER BASED ON BREACH OF CONTRACT, TORT (INCLUDING NEGLIGENCE), PRODUCT LIABILITY, OR OTHERWISE, IN CONNECTION WITH THE USE OF THE PRODUCT, EVEN IF HIKMICRO HAS BEEN ADVISED OF THE POSSIBILITY OF SUCH DAMAGES OR LOSS.

YOU ACKNOWLEDGE THAT THE NATURE OF THE INTERNET PROVIDES FOR INHERENT SECURITY RISKS, AND HIKMICRO SHALL NOT TAKE ANY RESPONSIBILITIES FOR ABNORMAL OPERATION, PRIVACY LEAKAGE OR OTHER DAMAGES RESULTING FROM CYBER-ATTACK, HACKER ATTACK, VIRUS INFECTION, OR OTHER INTERNET SECURITY RISKS; HOWEVER, HIKMICRO WILL PROVIDE TIMELY TECHNICAL SUPPORT IF REQUIRED.

YOU AGREE TO USE THIS PRODUCT IN COMPLIANCE WITH ALL APPLICABLE LAWS, AND YOU ARE SOLELY RESPONSIBLE FOR ENSURING THAT YOUR USE CONFORMS TO THE APPLICABLE LAW. ESPECIALLY, YOU ARE RESPONSIBLE, FOR USING THIS PRODUCT IN A MANNER THAT DOES NOT INFRINGE ON THE RIGHTS OF THIRD PARTIES, INCLUDING WITHOUT LIMITATION, RIGHTS OF PUBLICITY, INTELLECTUAL PROPERTY RIGHTS, OR DATA PROTECTION AND OTHER PRIVACY RIGHTS. YOU SHALL NOT USE THIS PRODUCT FOR ANY PROHIBITED END-USES, INCLUDING THE DEVELOPMENT OR PRODUCTION OF WEAPONS OF MASS DESTRUCTION, THE DEVELOPMENT OR

## Handheld Thermography Camera User Manual

---

PRODUCTION OF CHEMICAL OR BIOLOGICAL WEAPONS, ANY ACTIVITIES IN THE CONTEXT RELATED TO ANY NUCLEAR EXPLOSIVE OR UNSAFE NUCLEAR FUEL-CYCLE, OR IN SUPPORT OF HUMAN RIGHTS ABUSES.

IN THE EVENT OF ANY CONFLICTS BETWEEN THIS MANUAL AND THE APPLICABLE LAW, THE LATER PREVAILS.

## Regulatory Information

### FCC Information

Please take attention that changes or modification not expressly approved by the party responsible for compliance could void the user's authority to operate the equipment.

FCC compliance: This equipment has been tested and found to comply with the limits for a Class B digital device, pursuant to part 15 of the FCC Rules. These limits are designed to provide reasonable protection against harmful interference in a residential installation. This equipment generates, uses and can radiate radio frequency energy and, if not installed and used in accordance with the instructions, may cause harmful interference to radio communications. However, there is no guarantee that interference will not occur in a particular installation. If this equipment does cause harmful interference to radio or television reception, which can be determined by turning the equipment off and on, the user is encouraged to try to correct the interference by one or more of the following measures:

- Reorient or relocate the receiving antenna.
- Increase the separation between the equipment and receiver.
- Connect the equipment into an outlet on a circuit different from that to which the receiver is connected.
- Consult the dealer or an experienced radio/TV technician for help

This equipment should be installed and operated with a minimum distance 20cm between the radiator and your body.

#### FCC Conditions

This device complies with part 15 of the FCC Rules. Operation is subject to the following two conditions:

1. This device may not cause harmful interference.
2. This device must accept any interference received, including interference that may cause undesired operation.

### EU Conformity Statement



This product and - if applicable - the supplied accessories too are marked with "CE" and comply therefore with the applicable harmonized European standards listed under the EMC Directive 2014/30/EU, RE Directive 2014/53/EU, the RoHS Directive 2011/65/EU



2012/19/EU (WEEE directive): Products marked with this symbol cannot be disposed of as unsorted municipal waste in the European Union. For proper recycling, return this product to your local supplier upon the purchase of equivalent new equipment, or dispose of it at designated collection points. For more information see: [www.recyclethis.info](http://www.recyclethis.info)



2006/66/EC (battery directive): This product contains a battery that cannot be disposed of as unsorted municipal waste in the European Union. See the product documentation for specific battery information. The battery is marked with this symbol, which may include lettering to indicate cadmium (Cd), lead (Pb), or mercury (Hg). For proper recycling, return the battery to your supplier or to a designated collection point. For more information see: [www.recyclethis.info](http://www.recyclethis.info)

### Industry Canada ICES-003 Compliance

This device meets the CAN ICES-3 (B)/NMB-3(B) standards requirements.

1. This device complies with Industry Canada licence-exempt RSS standard(s). Operation is subject to the following two conditions: this device may not cause interference, and
  2. this device must accept any interference, including interference that may cause undesired operation of the device.
- 
1. Le présent appareil est conforme aux CNR d'Industrie Canada applicables aux appareils radioexempts de licence. L'exploitation est autorisée aux deux conditions suivantes : l'appareil ne doit pas produire de brouillage, et
  2. l'utilisateur de l'appareil doit accepter tout brouillage radioélectrique subi, même si le brouillage est susceptible d'en compromettre le fonctionnement.

Under Industry Canada regulations, this radio transmitter may only operate using an antenna of a type and maximum (or lesser) gain approved for the transmitter by Industry Canada. To reduce potential radio interference to other users, the antenna type and its gain should be so chosen that the equivalent isotropically radiated power (e.i.r.p.) is not more than that necessary for successful communication.



Conformément à la réglementation d'Industrie Canada, le présent émetteur radio peut fonctionner avec une antenne d'un type et d'un gain maximal (ou inférieur) approuvé pour l'émetteur par Industrie Canada. Dans le but de réduire les risques de brouillage radioélectrique à l'intention des autres utilisateurs, il faut choisir le type d'antenne et son gain de sorte que la puissance isotrope rayonnée équivalente (p.i.r.e.) ne dépasse pas l'intensité nécessaire à l'établissement d'une communication satisfaisante.

This equipment should be installed and operated with a minimum distance 20cm between the radiator and your body.

Cet équipement doit être installé et utilisé à une distance minimale de 20 cm entre le radiateur et votre corps.

## Symbol Conventions

The symbols that may be found in this document are defined as follows.

Symbol	Description
 <b>Danger</b>	Indicates a hazardous situation which, if not avoided, will or could result in death or serious injury.
 <b>Caution</b>	Indicates a potentially hazardous situation which, if not avoided, could result in equipment damage, data loss, performance degradation, or unexpected results.
 <b>Note</b>	Provides additional information to emphasize or supplement important points of the main text.

## Safety Instruction

These instructions are intended to ensure that user can use the product correctly to avoid danger or property loss.

### Laws and Regulations

- Use of the product must be in strict compliance with the local electrical safety regulations.

### Transportation

- Keep the device in original or similar packaging while transporting it.
- Keep all wrappers after unpacking them for future use. In case of any failure occurred, you need to return the device to the factory with the original wrapper. Transportation without the original wrapper may result in damage on the device and the company shall not take any responsibilities.
- DO NOT drop the product or subject it to physical shock. Keep the device away from magnetic interference.

### Power Supply

- Please purchase the charger by yourself. Input voltage should meet the Limited Power Source (7.2 VDC, 890 mA) according to the IEC61010-1 standard. Please refer to technical specifications for detailed information.
- Make sure the plug is properly connected to the power socket.
- DO NOT connect multiple devices to one power adapter, to avoid over-heating or fire hazards caused by overload.

### Battery

- Improper use or replacement of the battery may result in explosion hazard. Replace with the same or equivalent type only. Dispose of used batteries in conformance with the instructions provided by the battery manufacturer.
- The built-in battery cannot be dismantled. Please contact the manufacture for repair if necessary.
- For long-term storage of the battery, make sure it is fully charged every half year to ensure the battery quality. Otherwise, damage may occur.
- DO NOT charge other battery types with the supplied charger. Confirm there is no flammable material within 2 m of the charger during charging.
- DO NOT place the battery near heating or fire source. Avoid direct sunlight.
- DO NOT swallow the battery to avoid chemical burns.
- DO NOT place the battery in the reach of children.
- When the device is powered off and the RTC battery is full, the time settings can be kept for 3 months.
- The lithium battery voltage is 7.2 V, and the battery capacity is 4800 mAh.
- The battery is certified by UL2054.

## Maintenance

- If the product does not work properly, please contact your dealer or the nearest service center. We shall not assume any responsibility for problems caused by unauthorized repair or maintenance.
- A few device components (e.g., electrolytic capacitor) require regular replacement. The average lifespan varies, so periodic checking is recommended. Contact your dealer for details.
- Wipe the device gently with a clean cloth and a small quantity of ethanol, if necessary.
- If the equipment is used in a manner not specified by the manufacturer, the protection provided by the device may be impaired.
- We recommend you send the device back for calibration once a year, and please contact the local dealer for the information on maintenance points.
- Please notice that the current limit of USB 3.0 PowerShare port may vary with the PC brand, which is likely to result in incompatibility issue. Therefore it's advised to use regular USB 3.0 or USB 2.0 port if the USB device fails to be recognized by PC via USB 3.0 PowerShare port.

## Using Environment

- Make sure the running environment meets the requirement of the device. The operating temperature shall be -20°C to 50°C (-4°F to 122°F), and the operating humidity shall be 95% or less.
- This device can only be safely used in the region below 2000 meters above the sea level.
- Place the device in a dry and well-ventilated environment.
- DO NOT expose the device to high electromagnetic radiation or dusty environments.
- DO NOT aim the lens at the sun or any other bright light.
- When any laser equipment is in use, make sure that the device lens is not exposed to the laser beam, or it may burn out.
- The device is suitable for indoor and outdoor uses, but do not expose it in wet conditions.
- The level of protection is IP 54.
- The pollution degree is 2.

## Technical Support

The <https://www.hikmicrotech.com> portal will help you as a HIKMICRO customer to get the most out of your HIKMICRO products. The portal gives you access to our support team, software and documentation, service contacts, etc.

## Emergency

- If smoke, odor, or noise arises from the device, immediately turn off the power, unplug the power cable, and contact the service center.

## Laser Light Supplement Warning



Warning: The laser radiation emitted from the device can cause eye injuries, burning of skin or inflammable substances. Prevent eyes from direct laser. Before enabling the Light Supplement function, make sure no human or inflammable substances are in front of the laser lens. The wave



length is 650 nm, and the power is less than 1 Mw. The laser meets the IEC60825-1:2014 standard. Laser maintenance: It is not necessary to maintain the laser regularly. If the laser does not work, the laser assembly needs to be replaced in the factory under warranty. Keep the device power off when replacing laser assembly. Caution-Use of controls or adjustments or performance of procedures other than those specified herein may result in hazardous radiation exposure.

### **Manufacture Address**

Room 313, Unit B, Building 2, 399 Danfeng Road, Xixing Subdistrict, Binjiang District, Hangzhou, Zhejiang 310052, China  
Hangzhou Microimage Software Co., Ltd.

COMPLIANCE NOTICE: The thermal series products might be subject to export controls in various countries or regions, including without limitation, the United States, European Union, United Kingdom and/or other member countries of the Wassenaar Arrangement. Please consult your professional legal or compliance expert or local government authorities for any necessary export license requirements if you intend to transfer, export, re-export the thermal series products between different countries.

# Contents

<b>Chapter 1 Overview</b> .....	<b>1</b>
<b>1.1 Device Description</b> .....	<b>1</b>
<b>1.2 Main Function</b> .....	<b>1</b>
<b>1.3 Appearance</b> .....	<b>3</b>
<b>Chapter 2 Preparation</b> .....	<b>8</b>
<b>2.1 Charge Device</b> .....	<b>8</b>
<b>2.1.1 Charge Device via Cable Interface</b> .....	<b>8</b>
<b>2.1.2 Charge Device via Charging Base</b> .....	<b>8</b>
<b>2.2 Mount Hand Strap</b> .....	<b>9</b>
<b>2.3 Change Interchangeable Lens</b> .....	<b>10</b>
<b>2.4 Tilt Lens and Screen</b> .....	<b>12</b>
<b>2.5 Power On/Off</b> .....	<b>13</b>
<b>2.5.1 Set Auto Power-off Duration</b> .....	<b>13</b>
<b>2.6 Operation Method</b> .....	<b>13</b>
<b>2.7 Menu Description</b> .....	<b>14</b>
<b>Chapter 3 Display Settings</b> .....	<b>15</b>
<b>3.1 Focus</b> .....	<b>15</b>
<b>3.1.1 Focus Lens</b> .....	<b>15</b>
<b>3.1.2 Laser Assisted Focus</b> .....	<b>15</b>
<b>3.1.3 Auto Focus</b> .....	<b>16</b>
<b>3.1.4 Continuous Autofocus</b> .....	<b>16</b>
<b>3.1.5 High Temperature Priority</b> .....	<b>16</b>
<b>3.2 Set Screen Brightness</b> .....	<b>17</b>
<b>3.3 Set Display Mode</b> .....	<b>17</b>
<b>3.4 Set Palettes</b> .....	<b>18</b>
<b>3.5 Adjust Digital Zoom</b> .....	<b>18</b>
<b>3.6 Display OSD Info</b> .....	<b>18</b>
<b>Chapter 4 Temperature Measurement</b> .....	<b>20</b>
<b>4.1 Set Thermography Parameters</b> .....	<b>20</b>

4.1.1 Set Unit .....	21
4.2 Set Temperature Range .....	21
4.3 Set Thermography Rule.....	22
4.3.1 Set Point Rule .....	22
4.3.2 Set Line Rule .....	23
4.3.3 Set Area Rule .....	23
4.3.4 Set Temperature Difference Rule .....	24
4.3.5 Delete Rules.....	25
4.4 Set Temperature Alarm.....	25
Chapter 5 Picture and Video .....	26
5.1 Capture Picture.....	26
5.2 Record Video .....	27
5.3 Manage Albums.....	27
5.3.1 Create a New Album .....	27
5.3.2 Rename an Album .....	28
5.3.3 Change the Default Saving Album .....	28
5.3.4 Delete an Album.....	28
5.4 View Recorded Files .....	28
5.5 Manage Files.....	29
5.5.1 Delete a File .....	29
5.5.2 Delete Multiple Files .....	29
5.5.3 Move a File .....	30
5.5.4 Move Multiple Files.....	30
5.5.5 Add Text Note on File.....	31
5.5.6 Add Voice Note on File.....	31
5.6 Export Files .....	32

<b>Chapter 6 Distance Detection .....</b>	<b>33</b>
<b>Chapter 7 Connect Bluetooth .....</b>	<b>34</b>
<b>Chapter 8 Set LED Light .....</b>	<b>35</b>
<b>Chapter 9 Cast Screen.....</b>	<b>36</b>
<b>Chapter 10 Thermal View APP Connection.....</b>	<b>37</b>
<b>10.1 Connect via Wi-Fi.....</b>	<b>37</b>
<b>10.2 Connect via Hotspot .....</b>	<b>38</b>
<b>Chapter 11 Position Settings.....</b>	<b>39</b>
<b>11.1 Enable GPS .....</b>	<b>39</b>
<b>11.2 Set Compass.....</b>	<b>39</b>
<b>Chapter 12 Maintenance .....</b>	<b>40</b>
<b>12.1 View Device Information .....</b>	<b>40</b>
<b>12.2 Set Date and Time .....</b>	<b>40</b>
<b>12.3 Upgrade Device .....</b>	<b>40</b>
<b>12.4 Restore Device.....</b>	<b>40</b>
<b>Chapter 13 Appendix.....</b>	<b>41</b>
<b>13.1 Common Material Emissivity Reference .....</b>	<b>41</b>
<b>13.2 Device Command.....</b>	<b>41</b>
<b>13.3 Device Communication Matrix .....</b>	<b>42</b>
<b>13.4 FAQ.....</b>	<b>42</b>

# Chapter 1 Overview

## 1.1 Device Description

The handheld thermography camera is a device with both optical images and thermal images. It can do thermography, distance measurement, video recording, snapshot capturing, alarm, and it can connect to Wi-Fi, hotspot and Bluetooth. The built-in high-sensitivity IR detector and high-performance sensor detects the variation of temperature and measure the real-time temperature. The temperature measurement range is - 20 °C to 650 °C (- 4 °F to 1202 °F) with the accuracy of  $\pm 2$  °C ( $\pm 3.6$  °F) or 2%. The built-in laser module detects the target distance. The device is easy to use, and adopts ergonomic design. It is widely applied to substations, electricity prevention detection of companies, and reconnaissance survey of construction field.

## 1.2 Main Function

### Thermography

Device detects the real-time temperature, and display it on the screen.

### Distance Measurement

Device can detect the target distance with the laser light.

### Fusion

Device can display fusion of thermal view and optical view.

### Palette and Alarm

Device supports multiple palettes, and you can set the palette mode according to the alarm function.

### Client Software Connection

- Mobile Phone: Use HIKMICRO Viewer to see live image, capture, and recording, etc. on your phone.



HIKMICRO Viewer Android



HIKMICRO Viewer iOS

- PC: Use HIKMICRO Analyzer (<https://www.hikmicrotech.com/en/product-c-detail/18>) to see live

image, capture, recording, and receive alarm message, etc. on your PC.

### **Bluetooth**

Device can be connected to headset via Bluetooth, and you can hear the voice in the recording or capture.

### 1.3 Appearance

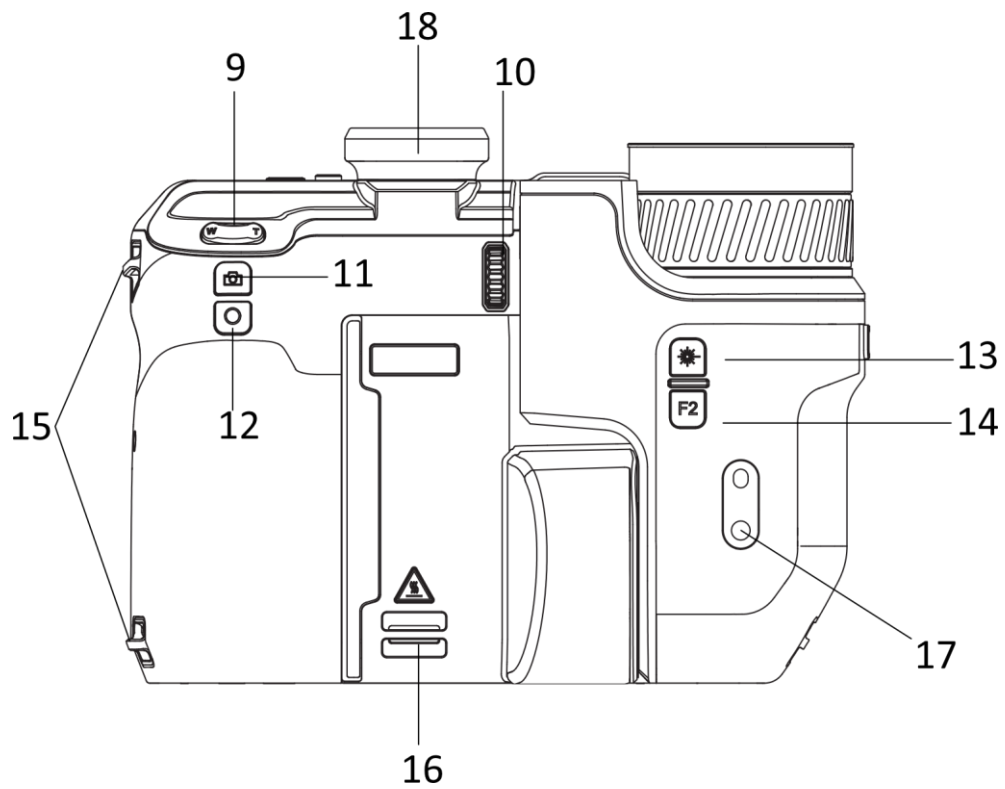
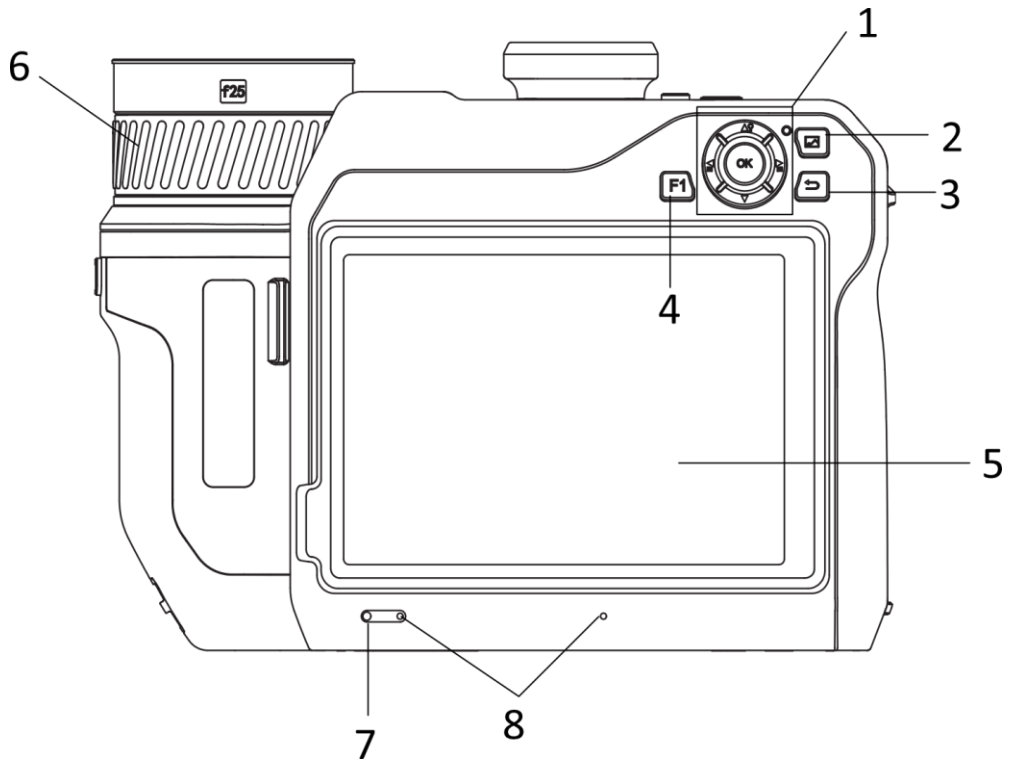

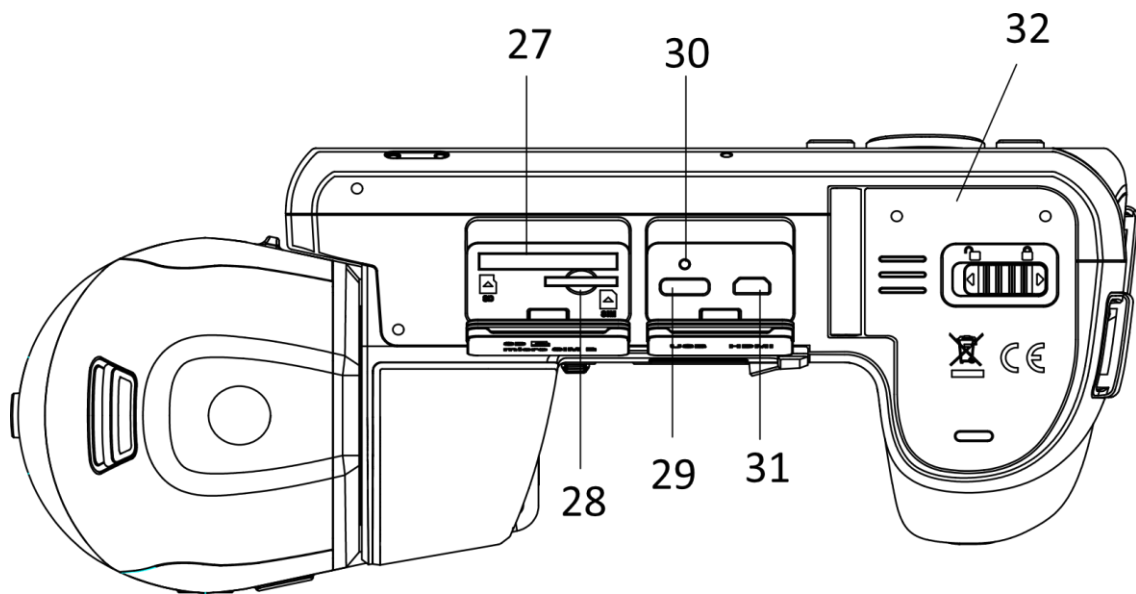
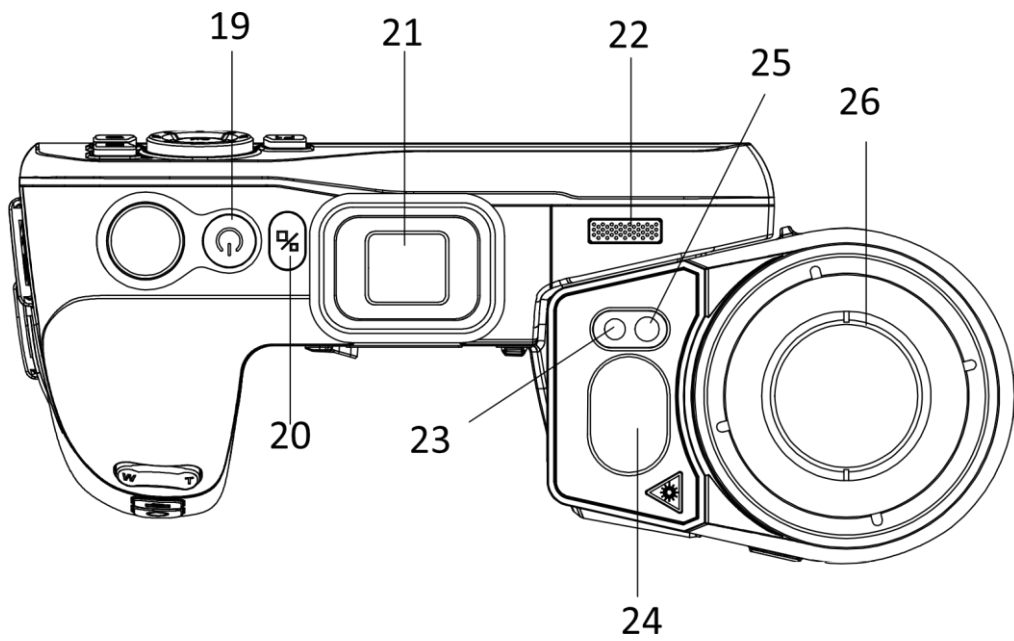



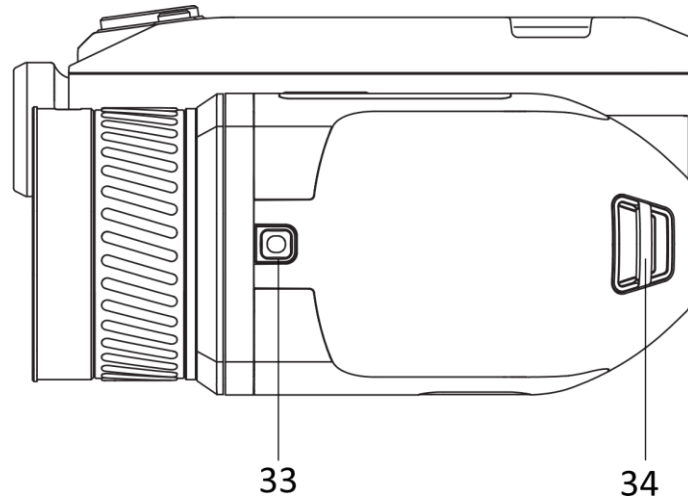

Figure 1-1 Appearance

Table 1-1 Button and Interface Description

No.	Description	Function
1	Navigation Button	Menu Mode: ● Press $\Delta$ , $\nabla$ , $\triangleleft$ , and $\triangleright$ to select parameters. ● Press OK to confirm. Non-Menu Mode: ● Press $\Delta$ to turn on/off the LED light supplement. ● Press $\triangleleft$ and $\triangleright$ to adjust focus.
2	File Button	Press to enter albums.
3	Back Button	Exit the menu or return to previous menu.
4 & 14	Function Button	Press to use the custom function.
5	Touch Screen	● Show the live view interface. ● Touch-screen operation.
6	Focus Ring	Adjust lens focal length.
7	Light Sensor	Sense the ambient brightness.
8	Microphone	Used to add voice note.
9	Zoom	Press $\text{T}$ to zoom in, and press $\text{W}$ to zoom out.
10	Diopter Adjustment Wheel	Adjust the dioptric correction for the viewfinder.
11	Capture Button	● Press: capture snapshots/stop recording ● Hold: start recording

## Handheld Thermography Camera User Manual

---

No.	Description	Function
12	Focus Button	Press to start focus.
13	Laser Button	<ul style="list-style-type: none"> <li>● Press: measure the distance with laser once</li> <li>● Hold: measure the distance with laser continuously</li> </ul>
15	Hand Strap Attachment Point	Mount the hand strap.
16 & 34	Neck Strap Attachment Point	Mount the neck strap.
17	Tripod Mount	Mount the tripod.
18	Viewfinder	View the live view and target in viewfinder mode.
19	Power Button	<ul style="list-style-type: none"> <li>● Press: standby mode/wake up device</li> <li>● Hold: power on/off</li> </ul>
20	Display Switch Button	Switch the LCD and the Viewfinder.
21	Eyepiece Plug	Protect the eyepiece.
22	Loudspeaker	Play voice note and voice alarm.
23	Optical Lens	View the optical image.
24	Laser Range Finder	Measure the distance with laser.
25	Supplement Light	Increase ambient brightness in dark environment.
26	Thermal Lens	View the thermal image.
27	Memory Card Slot	Insert the memory card in it.
28	<i>SIM Card Slot</i>	<i>Not Available.</i>
29	Data Exchange Interface	Charge the device or export files with supplied cable.
30	Indicator	Indicate the charging status of the device. <ul style="list-style-type: none"> <li>● Solid red: charging normally</li> <li>● Flashing red: charging exception</li> <li>● Solid green: fully charged</li> </ul>
31	HDMI Interface	Display the image and menu interface via HDMI output.
32	Battery Compartment	Install the battery in it.
33	Lens Release Button	Unlock the interchangeable lens.

 **Caution**

The laser radiation emitted from the device can cause eye injuries, burning of skin or inflammable substances. Before enabling the light supplement function, make sure no human or inflammable substances are in front of the laser lens.

## Chapter 2 Preparation

### 2.1 Charge Device

#### 2.1.1 Charge Device via Cable Interface

##### Before You Start

Please make sure the battery is installed before charging.

##### Steps

1. Lift the cover of cable interface.
2. Plug in the cable, and connect the power supply to charge the battery.

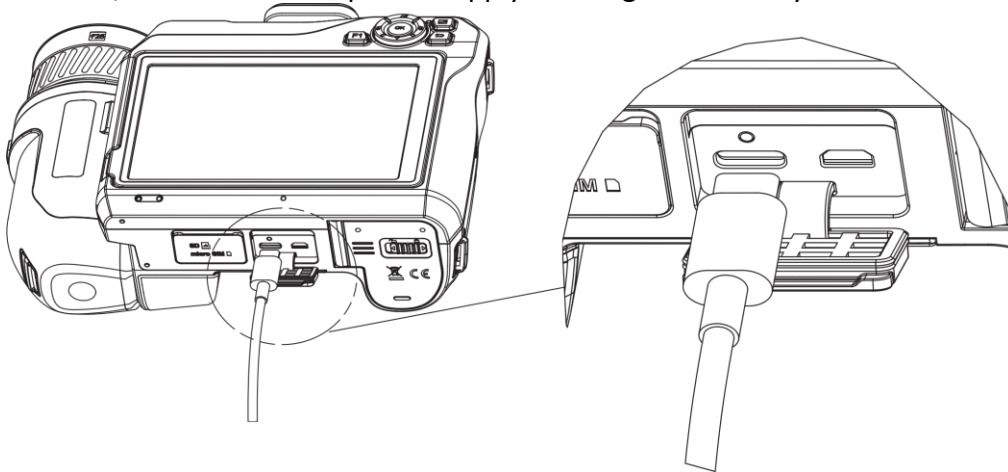

Figure 2-1 Charge the Battery via Type-C Cable

#### 2.1.2 Charge Device via Charging Base

##### Steps

---

##### Note

Please charge the device with the cable and power adapter supplied by the manufacturer (or according to the input voltage from the specifications).

---

1. Put one or two batteries in the charging base.
2. Connect the supplied charging base to the power supply. The indicator in the middle is green if it works properly.

3. The left and right indicators show the charging status of the batteries.
  - Solid red: charging normally.
  - Solid green: fully charged.
4. Draw the battery from the charging base, and disconnect charging base from the power supply.

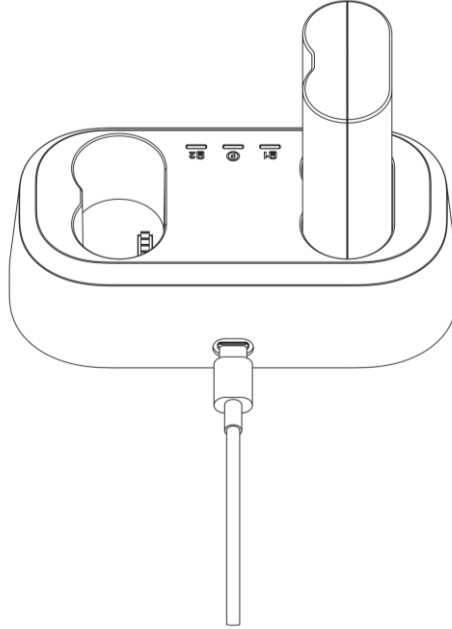

**Figure 2-2 Charge the Battery via Charging Base**

## 2.2 Mount Hand Strap

### Steps

1. Thread the hand strap through the hand strap clutch.



**Figure 2-3 Thread the Hand Strap**

2. Insert one end of the hand strap through the two hand strap attachment points

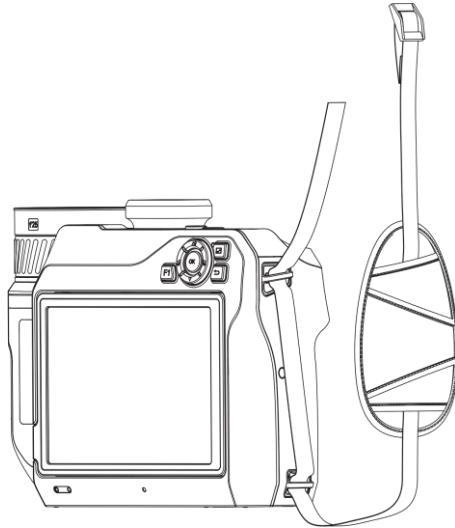

**Figure 2-4 Thread the Hand Strap Through Attachment Points**

3. Thread hand strap through the hand strap buckle, and fasten the hand strap.

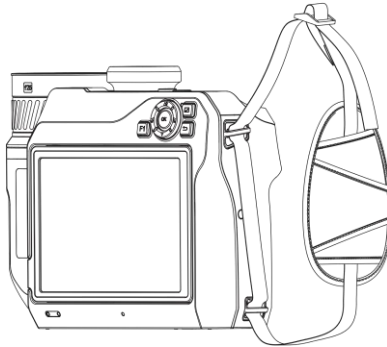

**Figure 2-5 Fasten the Hand Strap**

4. Adjust the tightness of the hand strap as needed.

## 2.3 Change Interchangeable Lens

An interchangeable lens is an additional thermal lens that can be mounted to the device to change the original focal length to different ranges, so as to obtain different FOVs and scene scopes.

### Before You Start

- Purchase a suitable interchange lens recommended by the device manufacturer.
- The device pops up a window to show the lens information or the calibration program when detecting a mounted lens.

### Steps

1. Press the lens release button and turn the interchangeable lens anticlockwise until it stops.

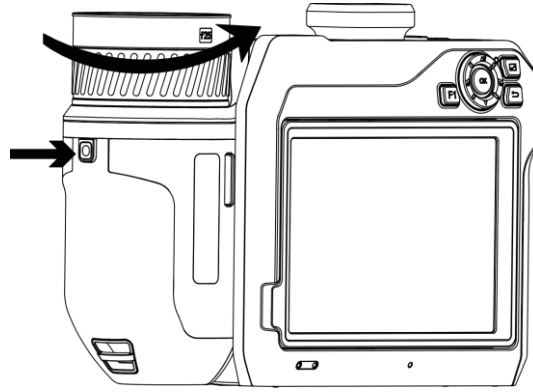

**Figure 2-6 Release the Lens**

2. Remove the interchangeable lens carefully.

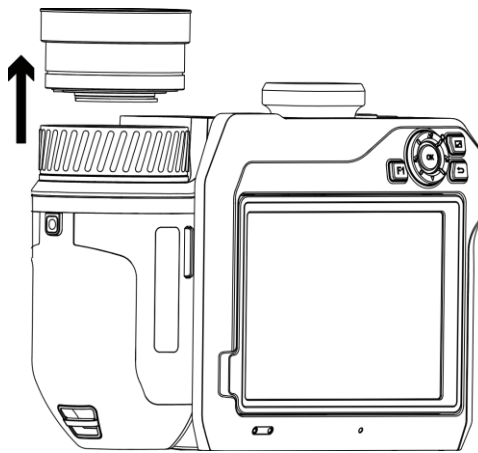

**Figure 2-7 Remove the Lens**

3. Align the two white index marks on the device and the lens.

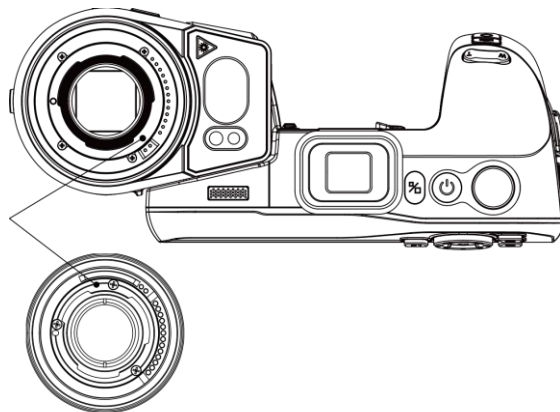

**Figure 2-8 Align the White Index Marks**

4. Push the lens into position.

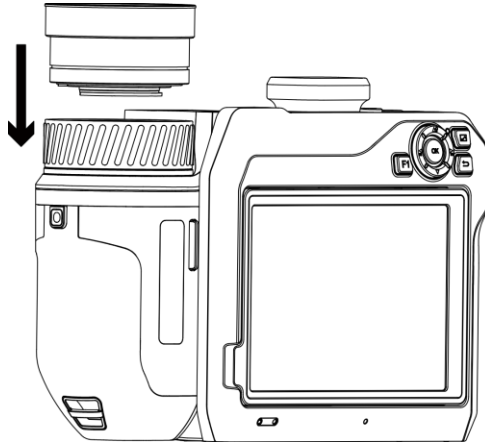

**Figure 2-9 Mount the Lens**

5. Rotate the lens clockwise to fix it. The lens makes a click when it locks in place.

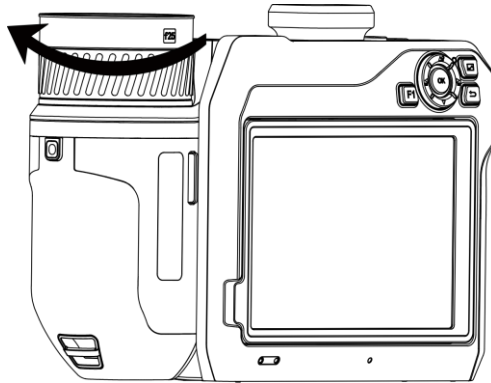

**Figure 2-10 Fix the Lens**

## 2.4 Tilt Lens and Screen

You can tilt the lens and screen for different observation angles, as shown in Figure 2-11.

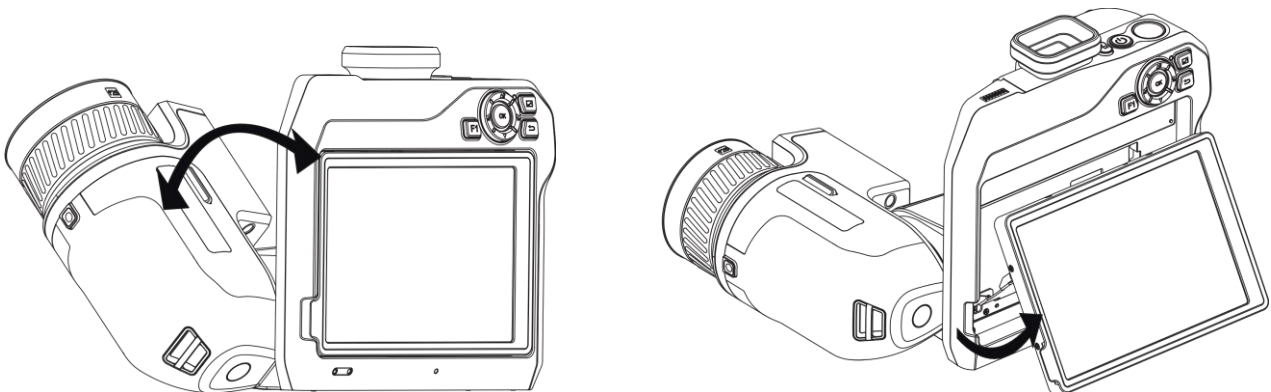

**Figure 2-11 Tilt Lens and Screen**



## 2.5 Power On/Off

### Power On

Remove the lens cover, and hold  for over three seconds to turn on the device. You can observe the target when the interface of the device is stable.

---

#### Note

It may take at least 30 s until the device is ready for using when you power on it.

---

### Power Off

When the device is turned on, hold  for three seconds to power off the device.

### 2.5.1 Set Auto Power-off Duration

Go to **Local Settings** → **Device Settings** → **Auto Off** to set the automatic shutdown time for device as required.

## 2.6 Operation Method

The device supports both touch-screen control and button control.

### Touch-Screen Control

Tap the screen to set parameters and configurations.

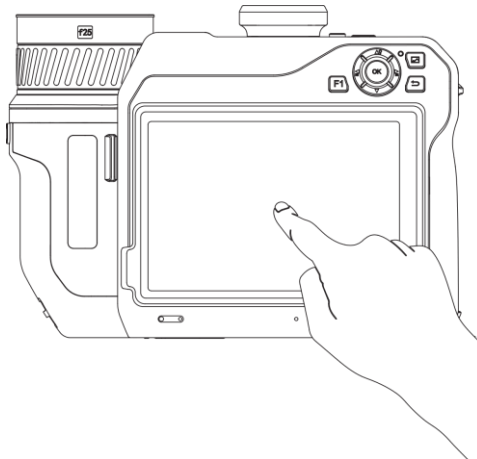
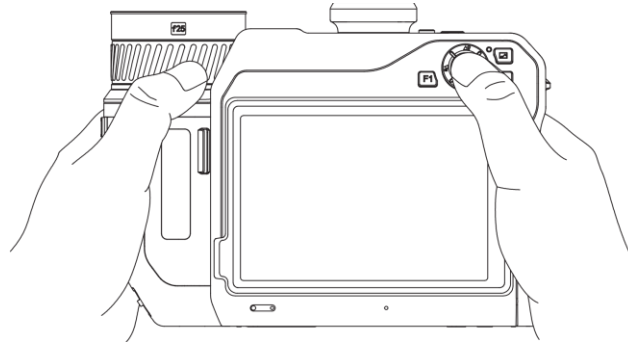

Figure 2-12 Touch-screen Control

### Button Control

Press the navigation buttons to set parameters and configurations.

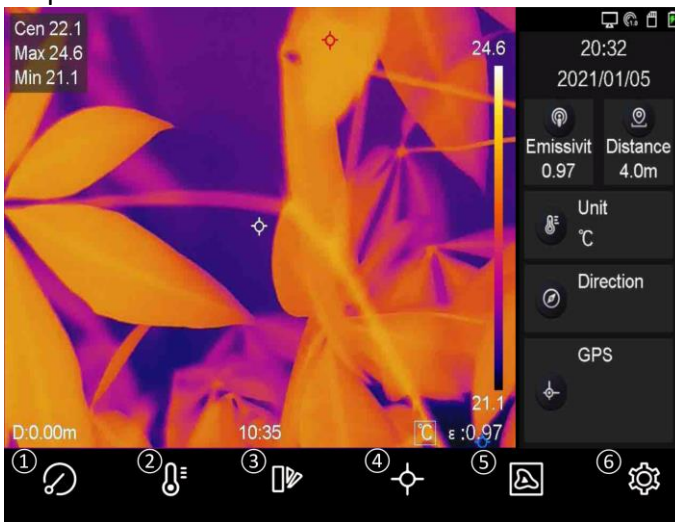

**Figure 2-13 Button Control**

- In menu mode, press  $\Delta$ ,  $\nabla$ ,  $\square$ , and  $\square$  to select parameters.
- Press **OK** to confirm.

## 2.7 Menu Description

In the observation interface, tap the screen to show the menu bar, and swipe down to call the swipe-down menu.



**Figure 2-14 Main Menu**

- ① FFC Button
- ② Temperature Range Button
- ③ Palettes Button
- ④ Thermography Button
- ⑤ Image mode button
- ⑥ Settings Button

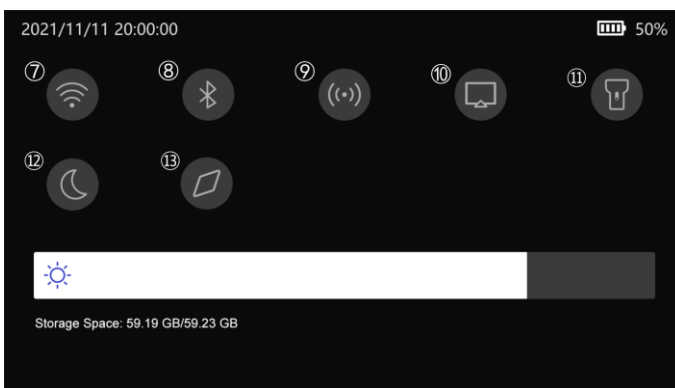

**Figure 2-15 Swipe-Down Menu**

- ⑦ Wi-Fi Button
- ⑧ Bluetooth Button
- ⑨ Hotspot Button
- ⑩ Screen Cast Button
- ⑪ Flashlight Button
- ⑫ Dark/Bright Mode Button
- ⑬ Compass Button

## Chapter 3 Display Settings

### 3.1 Focus

Adjust the lens focal length properly before you set any other configurations, or it may affect the image display and temperature accuracy.

#### 3.1.1 Focus Lens

##### Steps

1. Power on the device.
2. Aim the device lens to the appropriate scene.
3. Adjust the focus ring clockwise or anticlockwise. See Figure 3-1.

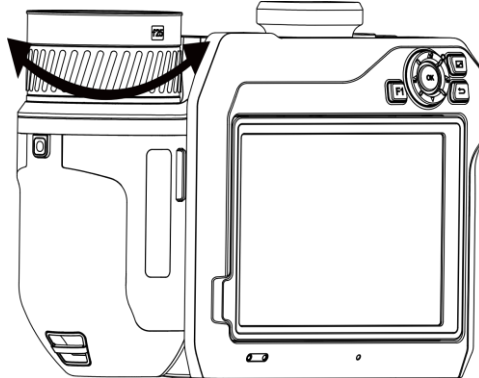

Figure 3-1 Focus Lens

---

##### Note

DO NOT touch the lens to avoid affecting the display effect.

---



#### 3.1.2 Laser Assisted Focus

Point the laser to the target and the device focuses automatically.

##### Before You Start

- It is recommended to use this function in a non-glare environment, such as indoor environment.
- The target should have good light reflection, such as white paper, cable.

##### Steps

1. Select , and go to **Capture Settings** → **Focus** → **Focus Mode** to enable **Laser Assisted Focus**.
2. In the live view interface, aim the cursor at the target and press  to finish focus.

---

## Note

DO NOT adjust the focus ring in this mode, or it will interrupt the focus process.

---

### 3.1.3 Auto Focus

The device focuses automatically by comparing the brightness, contrast, etc. in current scene.

#### Steps

1. Go to **Local Settings** → **Capture Settings** → **Focus** → **Focus Mode** to enable **Auto Focus**.
2. In the live view interface, aim the cursor at the target and press  to finish focusing.

---

## Note

DO NOT adjust the focus ring in this mode, or it will interrupt the focus process.

---

### 3.1.4 Continuous Autofocus

In continuous autofocus mode, the device focuses on the target automatically to make the scene clear. Use this mode when the device is stationary.

---

## Caution

Disable continuous autofocus mode when the device is moving, or it may affect the device function.

Go to **Local Settings** → **Capture Settings** → **Focus** → **Focus Mode** to enable **Continuous Autofocus**.

Then aim the device at the target, and the device focuses automatically.

---

## Note

Focus ring adjustment does not take effect in this mode.

---

### 3.1.5 High Temperature Priority

Enable the high temperature priority function if you want to focus on the high temperature object in the observation scene.

Go to **Local Settings** → **Capture Settings** → **Focus** to enable **High Temperature Priority**.

---

## Note

The high temperature priority function is only supported in auto focus mode and continuous autofocus mode.

---

## 3.2 Set Screen Brightness

There are two ways to adjust the screen brightness.

Go to **Local Settings** → **Device Settings** → **Display Brightness** to adjust the screen brightness. Or you can drag the brightness adjustment bar in the swipe-down menu.



Figure 3-2 Adjust Brightness via Swipe-Down Menu

## 3.3 Set Display Mode

You can set the thermal/optical view of the device. **Thermal**, **Fusion**, **PIP**, and **Optical** are selectable.

### Steps

1. Select  from the main menu.
2. Tap the icons to select a view mode.



In thermal mode, the device displays the thermal view.



In fusion mode, the device displays the combined view of thermal channel and optical channel.



In PIP (Picture in Picture) mode, the device displays thermal view inside the optical view.

---

### Note

You can drag the corners of the PIP frame to move, enlarge, or contract it.

---



In optical mode, the device displays the optical view.

3. Press  to exit.

## 3.4 Set Palettes

The palettes allow you to select the desired colors.

### Steps

1. Select  from the main menu.
2. Tap the icons to select a palette type.

#### White Hot

The hot part is light-colored in view.

#### Black Hot

The hot part is black-colored in view.

#### Rainbow

The target displays multiple colors. It is suitable for scene without obvious temperature difference.

#### Ironbow

The target is colored as heated iron.

#### Red Hot

The hot part is red-colored in view.

#### Fusion

The hot part is yellow-colored and the cold part is purple-colored in view.



#### Rain

The hot part in the image are colored, and the else is blue.

3. Press  to exit the setting interface.



---

### Note

You can also press , and  to switch the palettes.

---

## 3.5 Adjust Digital Zoom

In the live view interface, press  and  to adjust the digital zoom. Then you can view the target or scene in larger size.

## 3.6 Display OSD Info

Go to **Local Settings** → **Device Settings** → **Display Settings** to enable the information on-screen display.

**Status Icon**

The device status icons, for example, battery status, memory card, hotspot, etc.

**Time**

Device time and date.

**Parameters**

Thermography parameters, for example, target emissivity, temperature unit, etc.

**Distance Value**

Laser-measured target distance.

**Brand Logo**

The brand logo is a manufacturer logo displayed on the upper right corner of the screen.

## Chapter 4 Temperature Measurement

The thermography (temperature measurement) function provides the real-time temperature of the scene and display it on the left of your screen. The thermography function is turned on by default.

### 4.1 Set Thermography Parameters

You can set thermography parameters to improve the accuracy of temperature measurement.

#### Steps

1. Go to **Local Settings** → **Thermography Settings**.
2. Set the **Thermography Range**, **Emissivity**, etc.

#### Thermography Range

Select the temperature measurement range. The device can detect the temperature and switch thermography range automatically in **Auto Switch** mode.

#### Emissivity

Refer to [Common Material Emissivity Reference](#) to set the emissivity of your target.

#### Reflection Temperature

If any object (not the target) of high temperature is in the scene, and the target emissivity is low, set the reflection temperature as the high temperature to correct the thermography effect.

#### Distance

The distance between the target and the device. You can customize the target distance or select the target distance as **Near**, **Middle**, or **Far**.

#### Environment Temperature

The average temperature of the environment.

#### Humidity

Set the relative humidity of current environment.

#### Optical Transmissivity

Set the optical transmissivity of external optical material (e.g.: germanium window) to improve the temperature measuring accuracy.

#### External Optics Correction

Set temperature of the external optical material (e.g.: germanium window).

#### Temperature Display

Display the min. temperature, max. temperature, or average temperature on the screen.



3. Return to previous menu to save the settings.

---

## Note

You can go to **Local Settings** → **Device Settings** → **Device Initialization** → **Measurement Tool Initialization** to initialize the temperature measurement parameters.

---

### 4.1.1 Set Unit

Go to **Local Settings** → **Device Settings** → **Unit** to set the temperature unit and distance unit.

---

## Note

You can go to **Local Settings** → **Thermography Settings** → **Temperature Display** to enable/disable the temperature display.

---

## 4.2 Set Temperature Range

Set a temperature section and the palette only works for targets within the temperature section. You can adjust the temperature range.

### Steps

1. Select  from the main menu.
2. Select auto adjustment  or manual adjustment .

#### Auto Adjustment

Select . The device adjusts temperature range parameters automatically.

#### Manual Adjustment

Select .

There are 2 ways to manually adjust the range:

- Adjust the temperature range based on selected area.  
Tap an interest area of the screen. A circle is displayed around the area, and the palette readjusts to the temperature range of the area.
- Adjust the maximum and minimum temperature of the range.
  - Tap to select the max. temperature, min. temperature, or both.  
You can also tap the max. temperature or min. temperature at the ends of the palette bar to select them.
  - Tap the arrows on the right side of the screen to adjust the temperature value.

3. Press  to exit.

## 4.3 Set Thermography Rule

You can set thermography parameters to improve the accuracy of temperature measurement.





### Steps

1. Select  from the main menu.
2. Set the point, line, or area rules.

### 4.3.1 Set Point Rule

You can set four types of point thermography rules.

**Table 4-1 Icon Description**

Icon	Description
	Center Point Thermography
	High-temperature Point Thermography
	Low-temperature Point Thermography
	Custom Point Thermography

The setting method of center point, high-temperature, and low-temperature point thermography are all the same. Here is the example of setting high-temperature point thermography.

### Example

Tap  on the interface, the device locates the point of the highest temperature, and displays Max: XX.

### Custom Point Thermography

The device can detect the temperature of a custom point.

### Steps

1. Select .
2. Move the point with the navigation buttons or tap the touch-screen to select a point.  
The temperature of custom point (e.g. P1) displays P1: XX.
3. Repeat above steps to set other custom points.

---





### Note

At most ten custom points are supported.

---

### 4.3.2 Set Line Rule

#### Steps

1. Select . A line appears on the interface.
2. Press , , , and , or drag to move the line to the required position.
3. Drag points of the line on the touch-screen to extend or shorten the line.
4. (Optional) Tap the points of the line to set the emissivity and distance for the points

---

#### Note

Only one line is supported.

---









The maximum temperature, minimum temperature, and average temperature of the line display in the top left corner of the screen. The real-time temperature trend chart will display near the line.

#### What to do next

Displayed temperature types for the rule are configurable at **Local Settings** → **Thermography Settings** → **Temperature Display**.

### 4.3.3 Set Area Rule

#### Steps

1. Select . An area appears on the interface.
2. Move the area to the required position.
  - Press , , , and  to move the area up/down/left/right.
  - Tap and select the area on touch-screen to move the area.
3. Adjust the size of the area.
  - Tap one corner of the area, and press , , , and  to enlarge or contract the area.
  - Drag the corner of the area on touch-screen to enlarge or contract the area.
4. Press **OK**.

The maximum temperature, minimum temperature, and average temperature of the selected area are displayed on the left of the screen.
5. Repeat steps to set other areas.

---

#### Note

At most three areas are supported.

---

#### What to do next

Displayed temperature types for the rule are configurable at **Local Settings** → **Thermography Settings** → **Temperature Display**.



### 4.3.4 Set Temperature Difference Rule

You can set temperature difference rules based on the point, line, and area rules configured. The device will trigger an alarm when the temperature difference between the comparison objects exceeds the set alarm temperature difference threshold.

#### Before You Start

- Make sure you have configured at least one point, line, or area rule.
- Go to **Local Settings** → **Thermography Settings** → **Alarm Settings** → **Temperature Difference ( $\Delta T$ ) Alarm**, and enable this function.
- Go to **Local Settings** → **Thermography Settings** → **Alarm Settings** → **Alarm Linkage** to enable the alarm linkage method as needed.

#### Steps

1. In the live view interface, tap .
2. Select , and tap  to add a temperature difference rule.
3. Configure the parameters.

#### Rule Name

Set the name for the rule.

#### Rule Item

Select the point, line, or area rule you have configured, and set the corresponding temperature for the selected rule. **Min.**, **Max.**, and **Avg.** are selectable. You can also set a custom **Value** for comparison.



#### Alarming $\Delta T$

Set alarming temperature difference threshold for the rule. When the temperature difference between the comparison objects exceeds the set alarm temperature difference, the device will trigger and alarm.

3. Tap **OK** to finish the settings.
4. Repeat step 1 to step 3 to add more temperature difference rules.

---

#### Note

- The compared objects must be different. For example, you cannot compare the max. value of L1 with the max. value of L1.
  - At most 4  $\Delta T$  rules can be added.
  - Tap  to edit the existed  $\Delta T$  rule, tap  to hide the  $\Delta T$  information on the live view interface, and tap  to delete the selected  $\Delta T$  rule.
- 

#### Result

The device will alarm (audible warning/flashing alarm) when the temperature difference between the comparison objects exceeds the set alarm temperature difference threshold. The area flashes red if the area rule is configured.

### 4.3.5 Delete Rules

#### Delete All Rules

Tap  and press **OK** to clear all temperature rules.

#### Delete One Rule

In the observation interface, tap a rule (point, line or area) and enter the editing mode. Tap **Delete** to delete the rule.

## 4.4 Set Temperature Alarm

When the temperature of targets triggers the set alarm rule, the device will perform configured actions, such as, marking the alarming area with certain color, flashing the rule area, making an audible warning, or sending notification to the client software.

#### Steps

1. Go to **Local Settings** → **Thermography Settings** → **Alarm Settings** → **Temperature Alarm**.
2. Enable the function and set the alarm threshold and alert threshold.

#### Alarm Threshold

When the tested temperature exceeds the threshold, the device sends alarm notification to the client software. If the audible warning is enabled, and the flashlight will flash if the flashing alarm is enabled. The area flashes red if the area rule is configured.

#### Alert Threshold

When the tested temperature exceeds the threshold, the device sends alert notification to the client software.

3. Go to **Local Settings** → **Thermography Settings** → **Alarm Settings** → **Alarm Linkage**.
4. Enable **Audible Warning**, **Flash Alarm**, or both.

#### Audible Warning

The device triggers voice alarm when target temperature exceeds the alarm threshold.

#### Flash Alarm

The flashlight will flash when target temperature exceeds the alarm threshold.

---

#### Note

If the area rules are set to measure temperature, the alarm threshold, alert threshold and alarm linkage settings only work in the selected areas. Otherwise, the parameters are valid for pixel-to-pixel thermometry (whole-screen thermometry).

---

## Chapter 5 Picture and Video

Insert memory card into the device, then you can record videos, capture snapshots, and mark and save important data.

---

### Note

- Device does not support capturing or recording when the menu is shown.
  - When the device is connected to your PC, it does not support capturing or recording.
  - Go to **Local Settings** → **Capture Settings** → **Filename Header**, you can set the filename header for capturing or recording to distinguish the files recorded in a specify scene.
  - Go to **Local Settings** → **Device Settings** → **SD Card Initialization** to initialize the memory card as needed.
- 

### 5.1 Capture Picture

#### Before You Start

Press  in live view interface to enable flashlight in dark environment.

#### Steps

1. Go to **Local Settings** → **Capture Settings**.
2. Select **Photo Settings** to set the capture mode.

**Single Capture**                      Capture one picture for one time.



**Continuous Capture**            Capture multiple pictures for one time. You can set the amount of pictures.

**Timed Capture**                    Device captures one picture after the specified time interval. You can set the time interval as needed.

3. Select **Picture Type** to set the picture type.

**Offline Picture**                    Select this type when analyzing the picture with the client software. You can add remarks on the picture.

**Thermal**                                Select this type for custom software development. Remark on the picture is not allowed.

4. Optional: Set the optical resolution as needed.
5. Press  to exit.
6. In the live view interface, press  to capture snapshot.
7. Refer to **Export Files** to export the snapshots.

## 5.2 Record Video

### Before You Start

Press  in live view interface to enable the flashlight in dark environment.

### Steps



1. In the live view interface, hold  to start recording. The recording icon and count down number display in the interface.



Figure 5-1 Record Video

2. When you finish, hold  again to stop recording. The recording video will be saved automatically and exit.

---

### Note

You can also press **OK** or  to stop recording.

---



3. Refer to [Export Files](#) to export the snapshots.

## 5.3 Manage Albums

The recorded image/video files are saved in the albums. You can create new folders, rename a folder, change the default folder, move files between the folders, and delete folders.

### 5.3.1 Create a New Album

#### Steps

1. Press  to enter **Albums**.
2. Tap  to add a new album.
3. A soft keyboard is displayed, where you can enter the name of the album by touching the screen.

4. Tap  to finish.

---





### Note

The newly created album becomes the default saving album and appears at the top of the album list.

---



## 5.3.2 Rename an Album

### Steps

1. Press  to enter **Albums**.
2. Select the album to rename.
3. Tap , and select **Rename**. A soft keyboard is displayed.
4. Tap  to delete the old name, and enter the new name for the album by touching the screen.
5. Tap  to finish.

## 5.3.3 Change the Default Saving Album

### Steps

1. Press  to enter **Albums**.
2. Select the album you want to use as the default saving album.
3. Tap , and select **Set as Default Saving Album**.

---



### Note

The default saving album appears at the top of the album list.

---

## 5.3.4 Delete an Album

### Steps

1. Press  to enter **Albums**.
2. Select the album you want to delete.
3. Tap , and select **Delete**. A prompt box appears on the interface.
4. Tap **OK** to delete the album.

## 5.4 View Recorded Files

### Steps

1. Press  to enter **Albums**.



2. Tap to select the album storing the files.
3. Tap to select the video or snapshot to view.
4. View the selected file and relevant information.



**Figure 5-2 View a File**

---

## Note

For more information contained in capture snapshots or videos, you can install the thermography client to analyze them.

---

## 5.5 Manage Files

You can move, delete, and edit the recorded files. Voice notes and messages can be added to the files.

### 5.5.1 Delete a File

#### Steps

1. Press  to enter **Albums**.
2. Tap to select the album storing the file to be deleted.
3. In the album, tap to select the file to be deleted.
4. Tap **...**, and select **Delete**. A prompt box appears on the interface.
- 5 Tap **OK** to delete the file.

### 5.5.2 Delete Multiple Files



#### Steps

1. Press  to enter **Albums**.

2. Tap to select the album storing the files to be deleted.
3. In the album, tap , and tap the files to be deleted.

---

### Note

You can tap  to select all files, and tap  to cancel the selection.

---

4. Tap . A prompt box appears on the interface.
- 5 Tap **OK** to delete the files.

---



### Note

You can also delete a single file in this way.

---



## 5.5.3 Move a File

### Steps

1. Press  to enter **Albums**.
2. Tap to select the album storing the file to be moved.
3. In the album, tap to select the file to be moved.
4. Tap , and select **Move**. The album list is displayed.
- 5 Tap to select the album to move to.



## 5.5.4 Move Multiple Files

### Steps

1. Press  to enter **Albums**.
2. Tap to select the album storing the files to be moved.
3. In the album, tap  to select the files to be moved.

---

### Note

You can tap  to select all files, and tap  to cancel the selection.

---

4. Tap . The album list is displayed.
5. Tap to select the album to move to.

---



### Note

You can also move a single file in this way.

---

### 5.5.5 Add Text Note on File



#### Steps

1. Press  to enter **Albums**.
2. Tap to select the album storing the file to be edited.
3. In the album, tap to select the file to be edited.
4. Tap , and select **Text Note**. A soft keyboard is displayed.
5. Enter the text note by touching the screen.
6. Tap  to finish.

#### What to do next

You can open the edited photo to view the text note.

### 5.5.6 Add Voice Note on File

1. Press  to enter **Albums**.
2. Tap to select the album storing the file to be edited.
3. In the album, tap to select the file to be edited.
4. Tap , and select **Voice Note**. A microphone is displayed.
5. Tap the microphone to start/stop recording.

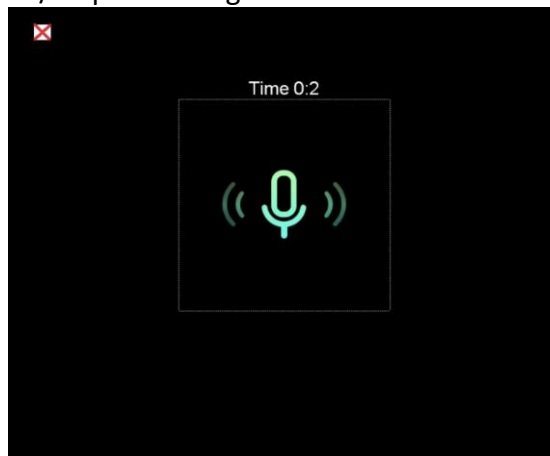



Figure 5-2 Record Voice Note

#### What to do next

You can open the edited photo, and tap the  to play the recording.

---

#### Note

Voice note can only be added on images.

---

## 5.6 Export Files

Connect the device to your PC with supplied cable, you can export the recorded videos and captured snapshots.

### Steps

1. Open the cover of cable interface.
2. Connect the device to your PC with cable and open the detected disk.
3. Select and copy the videos or snapshots to PC to view the files.
4. Disconnect the device from your PC.

---

### Note

For the first time connection, the driver will be installed automatically.

---



## Chapter 6 Distance Detection

The laser range finder consists of a laser transmitter and a laser receiver. The device detects the distance to a target by measuring the time it takes for a laser pulse to reach the target and return to the laser receiver. This time is converted to a distance, which is displayed on the screen.

### Before You Start

- It is recommended to use this function in non-glare environment, such as indoor environment.
- It is recommended that the target has good light reflection, such as white paper and cable.

### Steps

1. Select  from main menu.
2. Go to **Device Settings** → **Display Settings**.
3. Enable **Distance Value**.
4. Press  to save and exit.
5. In the live view interface, aim the cursor at the target and hold the laser button.
6. Release the laser button to finish distance measurement.



### Result

The distance displays on the screen when distance measurement is finished.

## Chapter 7 Connect Bluetooth

You can record and hear the sound contained in the videos or images via bluetooth headsets after pairing the device with bluetooth headsets successfully.

### Steps

1. Select  from the main menu.
2. Go to **Local Settings** → **Connect** → **Bluetooth**.
3. Tap  to enable the bluetooth.

---

### Note

You can also press  or **OK** to quit pairing.

---

The device will search the nearby enabled bluetooth headsets and pair them automatically.

### Result

After pairing you can record and hear the sound via the headsets while recording and playing the video or image.

## Chapter 8 Set LED Light

Press  in the live view to enable/disable the LED light. Or tap the flashlight button on the swipe-down menu.



## Chapter 9 Cast Screen

You can connect the device to your PC via a type-C cable, and cast the real-time live view of the device to your PC through the UVC alarm client. Then you can synchronously view the live view and parameters such as the maximum temperature, the distance, and the emissivity on your PC.

### Before You Start

Install the UVC Alarm Client on your PC.

### Steps

1. Select  from the main menu.
2. Go to **Local Settings** → **Connect** → **Cast Screen**.
3. Tap  to enable the function.
4. Open UVC Alarm Client on your PC.
4. Connect the device to your PC via a type-C cable.

### Result

The live view interface and parameters of the current image will be synchronously displayed on your PC.



## Chapter 10 Thermal View APP Connection



The device supports both Wi-Fi connection and hotspot. Connect the device to HIKMICRO Viewer, and you can control the device via mobile client.

### 10.1 Connect via Wi-Fi

#### Before You Start

Download and install HIKMICRO Viewer on your phone.

#### Steps

1. Select  from the main menu.
2. Go to **Local Settings** → **Connect** → **WLAN**.
3. Tap  to enable Wi-Fi, and the searched Wi-Fi will be listed.

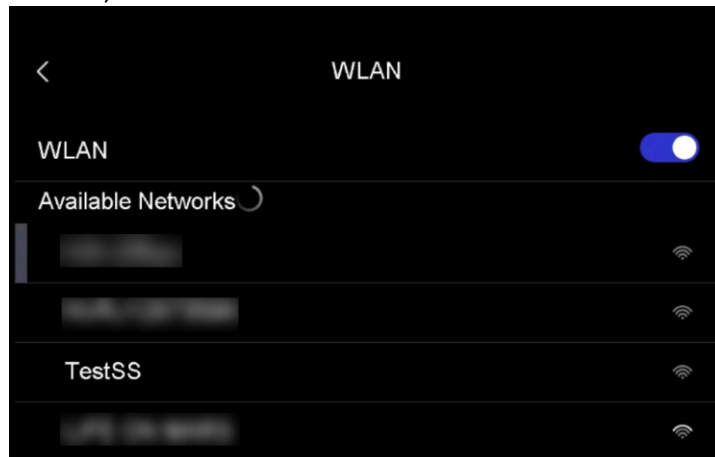

Figure 10-1 Wi-Fi List

4. Select the Wi-Fi to connect to. A soft keyboard is displayed.
5. Enter the password by touching the screen.

---

#### Note

DO NOT tap **enter** or **space**, or the password may be incorrect.

---

6. Tap  to save.
7. Launch the App and follow the startup wizard to create, and register an account.
8. Add the device to online devices.

#### Result



You can view the live view, capture snapshots, and record videos via the App.

## 10.2 Connect via Hotspot

### Before You Start

Download and install HIKMICRO Viewer on your phone.

### Steps

1. Select  from the main menu.
2. Go to **Local Settings** → **Connect** → **Hotspot**.
2. Tap  to enable the hotspot function. The hotspot name is the last 9 digits of the device serial No.
3. Tap **Set Hot Spot**. A soft keyboard is displayed.

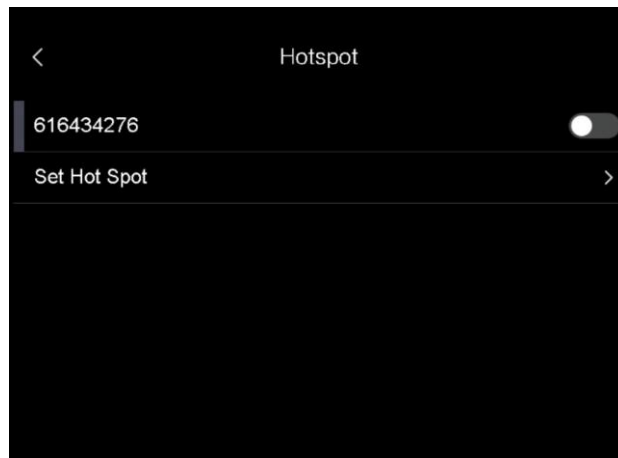



Figure 10-2 Set Hotspot

4. Set the password for the hotspot.

---

### Note

- DO NOT tap **enter** or **space**, or the password may be incorrect.
  - The password should contain at least 8 digits, consisting of numbers and characters.
- 

5. Tap  to save.
6. Connect your phone to the hotspot of the device.
7. Launch the App and follow the startup wizard to create, and register an account.
8. Select Wi-Fi configuration in the App, and enter the serial number of device to add the device.  
Refer to the manual of APP client for details.

### Result



You can view the live view, capture snapshots, and record videos via the App.

## Chapter 11 Position Settings

The device supports GPS and compass functions. You can locate the device position and determine the observation direction with these functions. The position and direction information is displayed on the right of the live view interface.

### 11.1 Enable GPS



#### Steps

1. Select  from the main menu.
2. Go to **Local Settings** → **Device Settings** → **GPS**.
3. Tap  to enable the GPS function. The device will prompt the GPS positioning result.

### 11.2 Set Compass

Enable the compass function to determine the observation direction. You need to calibrate the compass if there is magnetic field disturbance.

#### Steps

1. Select  from the main menu.
2. Go to **Local Settings** → **Device Settings** → **Compass**.
3. Tap  to enable the compass function. A prompt box appears on the interface.
4. Tap **OK** to start calibration, or tap **Cancel** to quit.
5. (Optional) Rotate the device according to the guidance below to calibrate the compass. The device will prompt the compass calibration result.

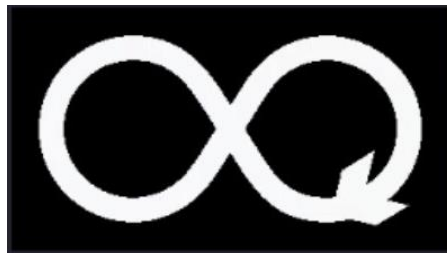

**Figure 11-1 Compass Calibration Guide**

6. (Optional) In the calibration interface, you can tap **Cancel** to quit the calibration.

---

#### **Note**

If you tap **Cancel** to quit the calibration, the direction information may be inaccurate.

---

## Chapter 12 Maintenance

### 12.1 View Device Information

Go to **Local Settings** → **Device Information** to view the device information.

### 12.2 Set Date and Time

#### Steps

1. Go to **Local Settings** → **Device Settings** → **Time and Date**.
2. Set the date and time.
3. Press  to save and exit.

---

#### Note

Go to **Local Settings** → **Device Settings** → **Display Settings** to enable or disable time and date display.

---

### 12.3 Upgrade Device

#### Steps

1. Connect the device to your PC with cable and open the detected disk.
2. Copy the upgrade file and paste it to the root directory of the device.
3. Disconnect the device from your PC.
4. Reboot the device and then it will upgrade automatically. The upgrading process will be displayed in the main interface.

---

#### Note

After upgrading, the device reboots automatically. You can view the current version in **Local Settings** → **Device Settings** → **Device Information**.

---

### 12.4 Restore Device

Go to **Local Settings** → **Device Settings** → **Device Initialization** to initialize the device and restore default settings.

## Chapter 13 Appendix

### 13.1 Common Material Emissivity Reference

Material	Emissivity
Human Skin	0.98
Printed Circuit Board	0.91
Concrete	0.95
Ceramic	0.92
Rubber	0.95
Paint	0.93
Wood	0.85
Pitch	0.96
Brick	0.95
Sand	0.90
Soil	0.92
Cloth	0.98
Hard Paperboard	0.90
White Paper	0.90
Water	0.96

### 13.2 Device Command

Scan the following QR code to get device common serial port commands.

Note that the command list contains the commonly used serial port commands for HikMicro thermal cameras.



### 13.3 Device Communication Matrix

Scan the following QR code to get device communication matrix.

Note that the matrix contains all communication ports of HikMicro thermal cameras.



### 13.4 FAQ

Scan the following QR code to get device common FAQ.





**HIKMICRO**

See the World in a New Way

Facebook: HIKMICRO Thermography    LinkedIn: HIKMICRO  
Instagram: hikmicro\_thermography    YouTube: HIKMICRO Thermography  
E-mail: info@hikmicrotech.com    Website: <https://www.hikmicrotech.com/>

**UD27178B**